



**Republic of Lithuania**

# **NATIONAL ASSESSMENT REPORT**

**TOPICAL PEER REVIEW OF FIRE PROTECTION  
UNDER NUCLEAR SAFETY DIRECTIVE 2014/87/EURATOM**

**Vilnius 2023**

NATIONAL ASSESSMENT REPORT OF THE REPUBLIC OF LITHUANIA	Page 2 of 163
CONTENT	

Lithuanian State Nuclear Power Safety Inspectorate (VATESI) prepared this National Assessment Report by the contribution of State Enterprise Ignalina Nuclear Power Plant.

National Assessment Report is available in pdf format at the VATESI website: [www.vatesi.lt](http://www.vatesi.lt).

NATIONAL ASSESSMENT REPORT OF THE REPUBLIC OF LITHUANIA FOR THE  
TOPICAL PEER REVIEW OF FIRE PROTECTION UNDER NUCLEAR SAFETY  
DIRECTIVE 2014/87/EURATOM

Publisher

State Nuclear Power Safety Inspectorate (VATESI)

A. Goštauto g. 12, LT-01108 Vilnius, Lithuania

[www.vatesi.lt](http://www.vatesi.lt); [atom@vatesi.lt](mailto:atom@vatesi.lt);

© VATESI 2023

NATIONAL ASSESSMENT REPORT OF THE REPUBLIC OF LITHUANIA	Page 3 of 163
CONTENT	

## CONTENT

ABBREVIATIONS .....	5
0. PREAMBLE / FOREWORD .....	7
1. GENERAL INFORMATION .....	8
1.1. Nuclear installations identification.....	11
1.1.1. Qualifying nuclear installations .....	11
1.1.2. National selection of installations for TPR II and justification (brief summary of) .....	11
1.1.3. Key parameters per installations .....	13
1.1.4. Approach to development of the NAR for the national selection .....	16
1.2. National regulatory framework .....	16
1.2.1. National regulatory requirements and standards .....	16
1.2.2. Implementation/Application of international standards and guidance.....	19
<b>2. FIRE SAFETY ANALYSES .....</b>	<b>20</b>
2.1. Dedicated spent fuel storage facilities.....	20
2.1.1. Spent Nuclear Fuel Storage Facility (SNFSF - 1).....	20
2.1.2. Interim Spent Nuclear Fuel Storage Facility (SNFSF - 2).....	23
2.2. Waste storage facilities.....	38
2.2.1. Solid Waste Retrieval Facility (retrieval from buildings 157, 157/1, B2-2 project) .....	38
2.2.2. Solid Waste Treatment and Storage Facilities (B3/4 project).....	60
2.2.3. Liquid Waste Storage Facilities (Building 151).....	86
2.2.4. Bituminized Waste Storage Facility (Building 158) .....	98
2.2.5. Cemented Waste Storage Facility (Building 158/2) .....	119
2.3. Facilities under decommissioning.....	130
2.3.1. Ignalina NPP Unit 2 .....	130
2.4. Licensee's experience of fire safety analyses .....	141
2.4.1. OSART mission .....	141
2.4.2. WANO mission .....	142
2.5. Regulator's assessment and conclusions on fire safety analyses .....	143
<b>3. FIRE PROTECTION CONCEPT AND ITS IMPLEMENTATION.....</b>	<b>145</b>
3.1. Fire prevention .....	145
3.1.1. Design considerations and prevention means .....	145
3.1.2. Overview of arrangements for management and control of fire load and ignition sources .....	145
3.1.3. Licensee's experience of the implementation of the fire prevention .....	145
3.1.4. Regulator's assessment of the fire prevention.....	145
3.2. Active fire protection .....	146
3.2.1. Fire detection and alarm provisions .....	146

## CONTENT

3.2.2.	Fire suppression provisions .....	146
3.2.3.	Administrative and organisational fire protection issues .....	147
3.2.4.	Regulator's assessment of the active fire protection .....	155
3.3.	Passive fire protection .....	155
3.3.1.	Prevention of fire spreading (barriers) .....	155
3.3.2.	Ventilation systems .....	155
3.3.3.	Regulator's assessment of the passive fire protection.....	156
3.4.	Licensee's experience of the implementation of the fire protection concept .....	157
3.5.	Regulator's assessment of the fire protection concept and conclusions ....	158
3.6.	Conclusions on the adequacy of the fire protection concept and its implementation.....	158
<b>4.</b>	<b>OVERALL ASSESSMENT AND GENERAL CONCLUSIONS .....</b>	<b>160</b>
<b>5.</b>	<b>REFERENCES TO THE NAR .....</b>	<b>162</b>

## ABBREVIATIONS

AI	- Action Indicator
BWSF	- Bituminized Waste Storage Facility
CB	- Control Building
CSS	- Cask Service Station
CFD	- Computational Fluid Dynamics
CFAST	- Computational Fire Growth and Smoke Transport
ENSREG	- European Nuclear Safety Regulators Group
FDP	- Final Decommissioning Plan
FDS	- Fire Dynamics Simulator
FHA	- Fire Hazard Analysis
FSAR	- Final Safety Analysis Report
HEL	- High Explosion Level
HVAC	- Heating, Ventilation and Air Conditioning
IAEA	- International Atomic Energy Agency
ISFSF	- Interim Spent Nuclear Fuel Storage Facility
LEI	- Lithuanian Energy Institute
LEL	- Lower Explosion Limit
LL	- Long-Lived
NAR	- National Assessment Report
NFPA	- National Fire Protection Association
NAR	- National Assessment Report
NI	- Nuclear Installation
NPP	- Nuclear Power Plant
NSD	- Nuclear Safety Directive
NUREG	- Nuclear Regulatory
OSART	- Operational Safety Review Team
PSR	- Periodic Safety Review
RU	- Retrieval Unit
SAR	- Safety Analysis Report
SD	- Smoke Detector
SE	- State Enterprise
SL	- Short-lived
SNFSF	- Spent Nuclear Fuel Storage Facility
SSC	- Structures, Systems and Components Important to Safety
SWRF	- Solid Waste Retrieval Facility
SWSF	- Solid Waste Storage Facility
SWTF	- Solid Waste Treatment Facility
SWTSF	- Solid Waste Treatment and Storage Facility
TPR	- Topical Peer Review
VATESI	- State Nuclear Power Safety Inspectorate

NATIONAL ASSESSMENT REPORT OF THE REPUBLIC OF LITHUANIA	Page 6 of 163
0. ABBREVIATIONS	

VFRS	- Visaginas Fire and Rescue Service
VLLW	- Very Low-Level Waste
WANO	- World Association of Nuclear Operators
WSF	- Waste Storage Facility
WTS	- Waste Transfer System
WENRA	- Western European Nuclear Regulators Association
UPS	- Uninterruptible Power System
USAR	- Updated Safety Analysis Report

NATIONAL ASSESSMENT REPORT OF THE REPUBLIC OF LITHUANIA	Page 7 of 163
0. PREAMBLE / FOREWORD	

## **0. Preamble / Foreword**

The European Union's Nuclear Safety Directive 2014/87/EURATOM requires the member states to undertake, on a coordinated basis, Topical Peer Reviews at least every 6 years with the first starting in 2017.

For each review the directive requires the following:

- a) a national assessment is performed, based on a specific topic related to nuclear safety of the relevant NIs on their territory,
- b) all other member states, and the Commission as observer, are invited to peer review the national assessment referred to in point (a),
- c) appropriate follow-up measures are taken of relevant findings resulting from the peer review process,
- d) relevant reports are published on the above-mentioned process and its main outcome when results are available.

The member states, acting through the European Nuclear Safety Regulators Group (ENSREG), have decided that the topic for the second TPR would be fire protection and national assessment reports shall be prepared in accordance with Technical Specification prepared by WENRA.

The objectives of the NAR are to:

- a) describe the overall fire safety for the relevant installations in the scope of the TPR II including:
  - how coordinated sampling approach and graded approach have been applied for the installations in the scope;
  - implementation of the overall fire safety programme;
  - experience regarding fire safety activities;
  - provide sufficient details according to a format which allows a meaningful peer review.
- b) identify potential strengths, weaknesses and actions to address them.

## 1. General Information

NIs that are covered by this NAR are operated by the State Enterprise (SE) Ignalina Nuclear Power Plant (NPP), which has appropriate licenses issued by the State Nuclear Power Safety Inspectorate (VATESI).

The Ignalina NPP is located in the northeastern part of Lithuania on the shore of Lake Drūkšiai, approximately 6 km from the city of Visaginas, near the state borders with Latvia and Belarus, at distances of approximately 8 and 4 km, respectively (Figure 1.1). The distances to the capital and major cities with populations exceeding 200,000 people more than 100 km.

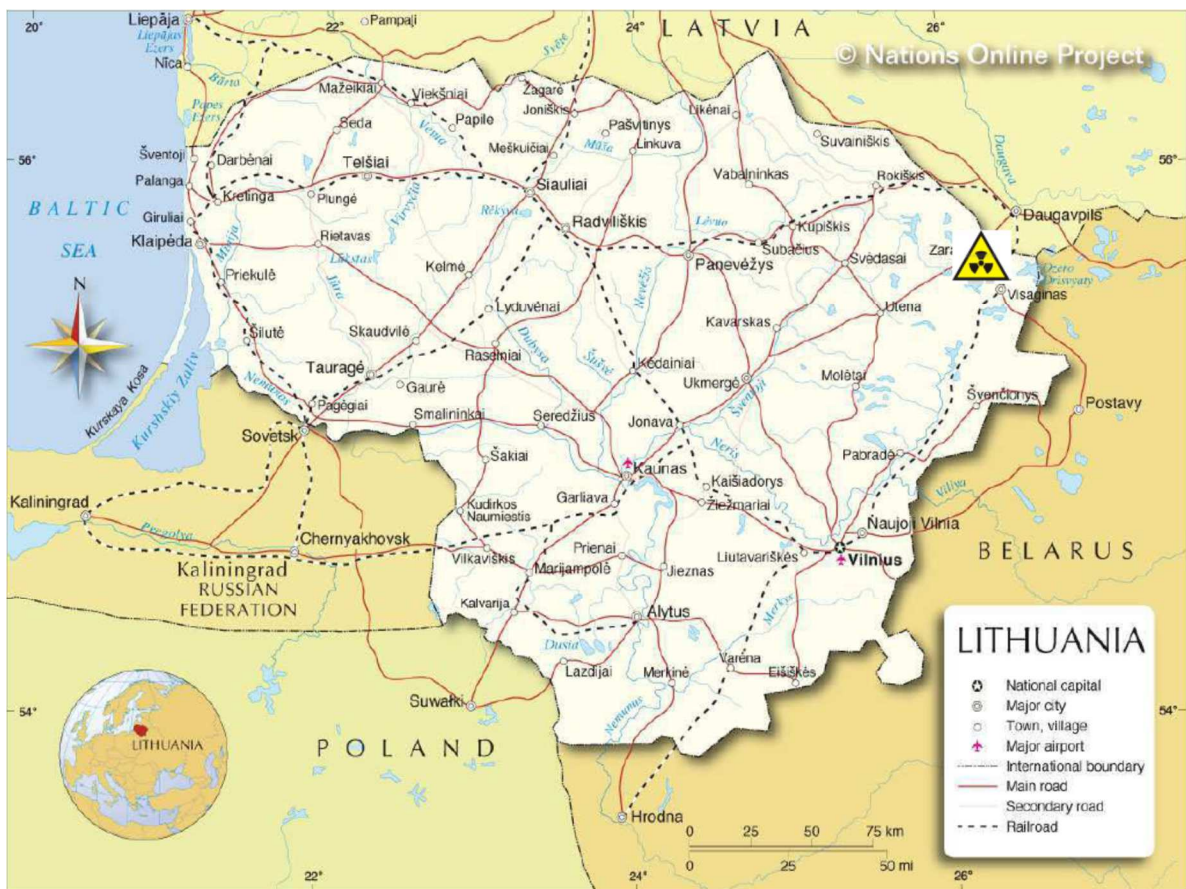

Figure 1.1. Ignalina NPP location

The location of the main buildings on the territory of the Ignalina NPP is shown in Figure 1.2.

Lithuania has one NPP, Ignalina NPP with two RBMK-1500 units, both of them are in permanent shutdown: Unit 1 – from 2004 and Unit 2 – from 2009. Both units of Ignalina NPP were defueled in 2022 and decommissioning activities are on going.

The decommissioning of a nuclear power plant is the last stage of power plant existence after it was designed, constructed, commissioned and operated. The goal of decommissioning is to achieve the condition when the territory is out of control of national supervisory authorities and may be used for other purposes.



## 1. GENERAL INFORMATION

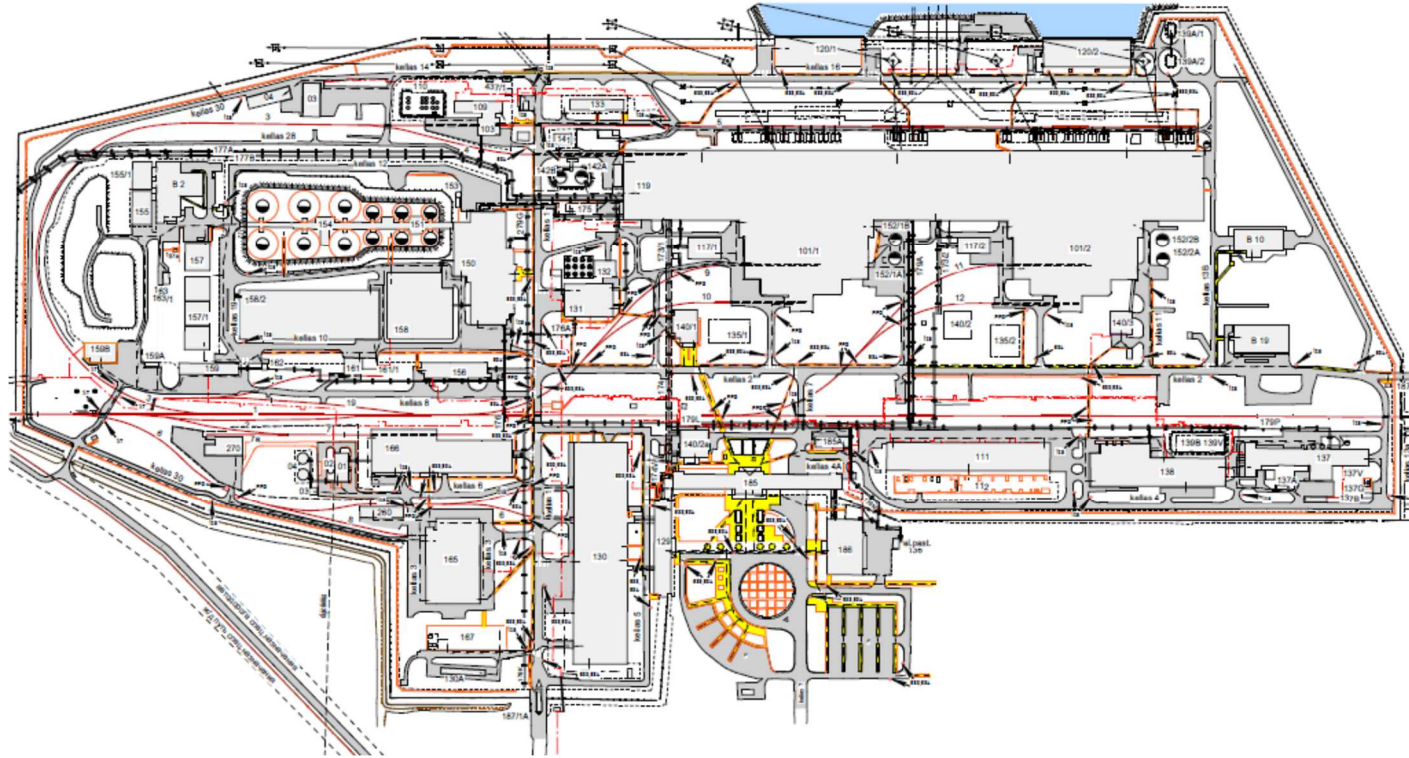

Figure 1.2 The layout plan of the buildings at the Ignalina NPP site

Building 101/1,2 - Main block (Units 1&2); Building 111 - Reserve diesel power station; Building 112 - Diesel fuel tanks; Building 117/1,2 - Gas contamination control building; Building 119 - Heat production unit; Building 120/1,2 - Technical water supply pump stations; Building 130 - Repair building; Building 130/2 - Repair building (contaminated part); Building 131 - Chemical water treatment building with electrolysis; Building 137 - Nitrogen-oxygen station; Building 138 - Compressor and refrigeration station; Buildings 140/1,2 - Sanitary passage; Building 150 - Liquid radioactive waste processing and bituminization facility; Building 151 - Sump water storage tanks; Buildings 152/1,2 - Low-salinity water storage tanks; Buildings 155/1,2 - Low-level radioactive waste storage facility; Building 156 - Special laundry facility; Buildings 157, 157/1 - Solid radioactive waste storage facilities; Building 158 - Bituminous waste storage facility; Building 158/2 - Cemented radioactive waste storage facility; Building 159 - Decontamination facility for special vehicles; Building 159B - Industrial waste management complex; Buildings 129, 185 - Administrative building; Building 161 - Bitumen storage; Building 163, Building 163/1 - Gas fire extinguishing station; Building 165 - Unused nuclear fuel storage; Building 166 - Warehouse; Building 186 - Cafeteria; Buildings 01 - 04 - Steam boiler house; Building B10 - Radioactivity measurement facility for materials beyond uncontrolled levels; Building B19 - Buffer storage for Low and Intermediate-Level Radioactive Waste surface repository Landfill.

NATIONAL ASSESSMENT REPORT OF THE REPUBLIC OF LITHUANIA	Page 10 of 163
1. GENERAL INFORMATION	

Nuclear safety requirements BSR-1.5.1-2019 “Decommissioning of Nuclear Facilities” are the main legislative document whereby Ignalina NPP plans and carries out the decommissioning.

Ignalina NPP decommissioning project includes decommissioning of Unit 1 and 2 and auxiliary facilities.

On 26 November 2002, the Lithuanian Government adopted a resolution to the effect that the Ignalina NPP Unit 1 is to be decommissioned through immediate dismantling in order to avoid serious social, economic, financial and environmental consequences.

The choice of method of decommissioning was influenced by various factors: economic, social, safety aspects and decommissioning work experience at others NPPs.

Representatives of the Ignalina NPP were also in favor of immediate dismantling because in this case prerequisites would be created for improving employment rate - experienced professionals would be invoked. One of the Ignalina NPP decommissioning priorities is in-house approach - to perform as many works as possible with Ignalina NPP personnel help.

The Final Decommissioning Plan [5.31] was prepared in 2001–2004 by the Ignalina NPP and approved by the order of the Minister of Economy of the Republic of Lithuania in 2005. Ministry of Economy of the Republic of Lithuania coordinated the Ignalina NPP decommissioning process by 2009. Currently, Ministry of Energy of the Republic of Lithuania performs this function. On 25 August 2014, the Minister of Energy of the Republic of Lithuania approved Revision 7 of the FDP covering amendments made according to the experience gained by the Ignalina NPP. The FDP was last updated and approved in 2020.

The FDP covers the entire Ignalina NPP decommissioning period (two units, auxiliary equipment, interim spent fuel facility and radioactive waste storage facilities). Decommissioning activities and projects are planned on the basis of the strategy presented in this FDP (all decommissioning activities are grouped into decommissioning projects in the FDP), principles, methods, techniques and the overall plan-timetable are described that are required for ensuring safe, ecological and economic Ignalina NPP decommissioning from the radiation safety point of view.

In the context of current decommissioning plans and uncertainties, thus far it can only be declared that the target is to clean up and transfer as much of the Ignalina NPP territory as possible for unsupervised management (to award this part the “green field” status).

The “green field” condition means the final condition of a nuclear facility / its site, after the achievement of which the concentration of radionuclide activity in buildings and at the site (or part thereof) does not exceed unconditional release levels of radioactivity, and there are no restrictions due to the possible effects of ionizing radiation established on the use of the buildings and site of this facility.

The “green field” condition is the currently planned target condition, however, taking into account the contamination level of the buildings and site as well as the possibility of further use of the buildings and infrastructure, a decision may be adopted that the final target condition would be brown (“brown field”).

The “brown field” condition means the final condition of a nuclear facility / its site, after the achievement of which the concentration of radionuclide activity in buildings and at the site (or part thereof) exceeds unconditional release levels of radioactivity, and the use of the site (or part thereof) is allowed only with restrictions due to the possible effects of ionizing radiation – in this case, during the further use of the site, safety is to be ensured by administrative measures. The restrictions on the use of a “brown field” can only be imposed if the actual types of use of the “brown field” (as well as its buildings and structures) are known.

The “brown field” option may be selected on the territory of the first and second unit taking into account the safety justification for such use, on the basis of requirements of legal acts, economic and

## 1. GENERAL INFORMATION

social factors, taking into account the obtained measurements of the radionuclide activity concentrations and (or) surface activity values, as well as the possibilities and value of monitoring lower activity levels, when the actual types (options) of use of the “brown field” are known.

The decision on the target condition of the site must be adopted after the engineering studies on the block buildings release from the radiation control are conducted, which, in accordance with the current state of the Megaproject, should be completed by 31/03/2027, and taking into account the results of the works for determining conditional release levels of radioactivity at the industrial waste site. Until a decision regarding the reasonableness of achieving the brown condition (“brown field”) is adopted, the target condition is a “green field”.

## 1.1. Nuclear installations identification

### 1.1.1. Qualifying nuclear installations

Brief overview of the installations (initial list and proposed selection) shown in Table 1.1.

TABLE 1.1

Installation category	Number of installations	Candidate installations
Nuclear power plant	-	-
Research reactor	-	-
Fuel reprocessing facility	-	-
Fuel fabrication facility	-	-
Fuel enrichment facility	-	-
Dedicated spent fuel storage	2	2 SNFSF - 1 SNFSF - 2
Installations under decommissioning	2	1 Ignalina NPP Unit 2
On-site radioactive waste storage	7	5 Solid Waste Management and Storage Facilities (B3/4 project) Solid Waste Retrieval Facility (retrieval from buildings 157, 157/1, B2-2 project) Liquid Waste Storage Facilities (Building 151) Bituminized Waste Storage Facility (Building 158) Cemented Waste Storage Facility (Building 158/2)
Total	11	8

### 1.1.2. National selection of installations for TPR II and justification (brief summary of)

The list of the NIs excluded as not posing a potential significant radiological risk in case of a fire shown in Table 1.2.

## 1. GENERAL INFORMATION

TABLE 1.2

Name of the facility	Type	Technology / main characteristics	State of operation	Additional Information / Rationale
Solid Waste Retrieval Facility (retrieval from buildings 155, 155/1, B2-1 project)	WSF	Retrieval of solid, not treated radioactive waste, and pre-sorting	operation	Waste is classified as short-lived very low-level waste (VLLW) and, as it was indicated in SAR, fires have insignificant radiological risks to workers, the public and/or the environment.
Very low-level waste storage facility (B19-1)	WSF	Temporary storage of very low-level radioactive waste	operation	Waste is classified as VLLW and, as it was indicated in SAR, fires have insignificant radiological risks to workers, the public and/or the environment.

The list of the candidate installations that will be reported on (together with the rationale and criteria) and the corresponding “represented installations” shown in Table 1.3.

TABLE 1.3

Name of the facility	Type	Status	Represented Installation	Additional Information / Rationale
Ignalina NPP Unit 2	NPP	decommissioning	Ignalina NPP Unit 1	The fire safety concept of both Ignalina NPP Units is the same, so it is proposed to select Unit 2 as the “Candidate” installation for TPR-II. Additionally, Unit 2 was shut down later than Unit 1, and there is more safety important SSCs.
Spent Nuclear Fuel Storage Facility (SNFSF - 1)	SNFSF	operation	none	There are no combustible materials near the casks and the casks in SNFSF-1 are stored in open walled area. This facility is included in the analysis according to recommendation of the TPR-II board.
Interim Spent Nuclear Fuel Storage Facility (SNFSF - 2)	SNFSF	operation	none	SNFSF-2 is a more complex building, compared with SNFSF-1, with the roof and contains systems and components with combustible materials (for instance, cables, electric motors). The system for fuel handling, including welding of casks, “hot cell”, is foreseen. Taking into consideration the above mentioned, fires could have the potential to result in radiological risks to workers, the public and/or the environment by impairing safety barriers.

## 1. GENERAL INFORMATION

Solid Waste Retrieval Facility (retrieval from buildings 157, 157/1) - B2-2	WSF	operation	none	Fires have the potential to result the radiological risks to workers, the public and/or the environment by impairing safety barriers.
Solid Waste Management and Storage Facilities B3/4	WSF	operation	none	Fires have the potential to result in the radiological risks to workers, the public and/or the environment by impairing safety barriers.
Liquid Waste Storage Facilities (Building 151)	WSF	operation	none	Fires have the potential to result in the radiological risks to workers.
Bituminized waste Storage facility (Building 158)	WSF	operation	none	Fires have the potential to result in significant radiological risks to workers, the public and/or the environment by impairing safety barriers.
Cemented waste Storage facility (Building 158/2)	WSF	operation	none	Fires have the potential to result in the radiological risks to workers, the public and/or the environment by impairing safety barriers.

**1.1.3. Key parameters per installations**

Key parameters for dedicated spent fuel storage facilities and waste storage facilities shown in Table 1.4.

TABLE 1.4

Name of the facility	Type	Licensee	Year of first operation	Scheduled shutdown date (if any)
Spent Nuclear Fuel Storage Facility (SNFSF - 1)	SNFSF	State Enterprise Ignalina Nuclear Power Plant	2000	The Technical Specification provides a condition that the design life of storage casks and civil structures is 50 years from the final placement of the spent fuel in the storage facility (which took place in 2010), plus a 5-year extension for the subsequent transportation of the fuel to a different location.
Interim Spent Nuclear Fuel Storage Facility (SNFSF - 2) (B1 project)	SNFSF	State Enterprise Ignalina Nuclear Power Plant	2017	The casks loaded with SNF are transferred from the reactor units into the newly constructed ISFSF for long-term interim storage. The Technical Specification provides a condition that the design life of storage cask and civil structures is 50 years from the final placement of the spent fuel in the storage facility plus a 5-year extension for the subsequent transportation of the fuel to a different location. Regular inspections, maintenance and repairs, and after investigations of the cask and civil structures, the design life of the ISFSF can be prolonged. <b>Remark:</b> the last cask with spent fuel was transferred in April 2022.

## 1. GENERAL INFORMATION

Solid Waste Retrieval Facility (retrieval from buildings 157, 157/1, B2-2 project)	WSF	State Enterprise Ignalina Nuclear Power Plant	2020	The decommissioning of the Retrieval units 2 and 3 could be started when all radioactive waste will be retrieved from 157/1 and 157 temporary storages (~2038).
Solid Waste Management and Storage Facilities (B3/4 project)	WSF	State Enterprise Ignalina Nuclear Power Plant	2022	Solid Waste Management Facility (B3) Start of decommissioning -2039. End – 2044 Solid Waste Storage Facility (B4) - Start of decommissioning -2069. End – 2075
Liquid Waste Storage Facility (Building 151)	WSF	State Enterprise Ignalina Nuclear Power Plant	1983	2035 Demolished
Bituminized waste Storage Facility (Building 158)	WSF	State Enterprise Ignalina Nuclear Power Plant	1987	~2050 Considering the implementation of the transformation of the Waste Storage Facility into a Landfill, the B20 project
Cemented waste Storage facility (Building 158/2)	WSF	State Enterprise Ignalina Nuclear Power Plant	2006	~2064 Considering the decisions regarding the management of the waste generated from dismantling the reactors.

Key parameters for installations under decommissioning shown in Table 1.5.

TABLE 1.5

Name of the facility	Type	Licensee	Year of end operation	Year of authorization for decommissioning	Scheduled end of decommissioning operations date	Intended end state
Ignalina NPP Unit 2	NPP	State Enterprise Ignalina Nuclear Power Plant	2009	Dismantling and decontamination projects have been authorized since 2013. Decommissioning license for both Units, which can only be issued after the spent nuclear fuel has been unloaded, is planned ~2023	2038	The buildings will be demolished and the site is planned to be free released from regulatory control ("green field").

The location of the candidate NIs that will be reported at the territory of the Ignalina NPP is shown in Figure 1.3

1. GENERAL INFORMATION

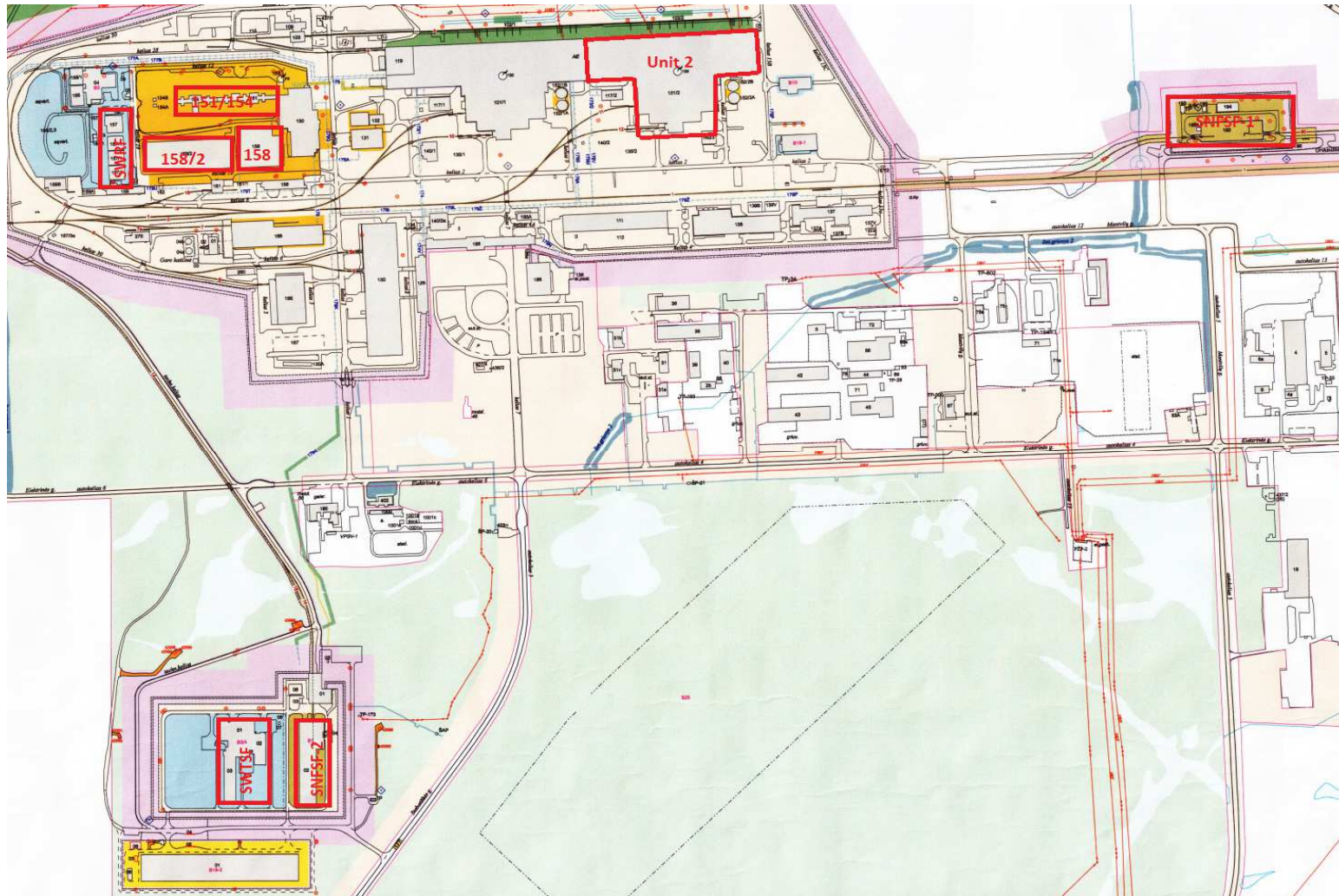

Figure1.3 The layout plan of candidate NIs at the Ignalina NPP site

NATIONAL ASSESSMENT REPORT OF THE REPUBLIC OF LITHUANIA	Page 16 of 163
1. GENERAL INFORMATION	

#### **1.1.4. Approach to development of the NAR for the national selection**

This NAR provides an assessment of nuclear installations with a potential risk of spreading radioactive materials in the event of a fire.

Upon request of VATESI, SE Ignalina NPP prepared a draft of NAR in accordance with TPR-II technical specifications. VATESI reviewed a draft of the NAR, added its own assessment on the fire safety analysis and reached an agreement on the final NAR with SE Ignalina NPP.

The NAR is to be delivered to the ENSREG and published at the VATESI's website after its finalization.

### **1.2. National regulatory framework**

#### **1.2.1. National regulatory requirements and standards**

Law on Fire Safety establishes the legal basis for ensuring and organizing fire safety in the Republic of Lithuania, the system of ensuring fire safety, the functions of state and municipal institutions and agencies, as well as the rights and duties of residents, enterprises, agencies and organizations in the field of fire safety.

The general fire safety requirements for nuclear facilities are set out in the Law on Fire Safety [5.1], as well as in its sub-legislation [5.8-5.29], approved by the Fire and Rescue Department under the Ministry of the Interior, Ministry of the Interior and Ministry of the Environment of the Republic of Lithuania. The specific fire safety requirements for nuclear facilities are set in nuclear safety and nuclear energy laws [5.2-5.3] and VATESI regulations. VATESI develops, specifies, and approves in accordance with the prescribed procedure normative/technical documentation and supervises compliance with requirements that ensure fire protection of safety important SSCs.

Nuclear Safety Requirements BSR-1.7.1-2014 "Fire Safety of Structures, Systems and Components Important to Safety of Nuclear Installation" establish requirements for fire safety of SSCs important to safety of NI. The main goals of the requirements are:

- 1) to establish the applicable criteria and requirements for the protection against fires of SSCs important to safety of NI, including the commissioning and decommissioning stages, and aims to prevent or to limit the consequences of such fires;
- 2) to establish the requirements to apply defense in depth principle for the design fire safety assurance measures of SSCs important to safety of NI;
- 3) to establish the requirements for subdivision of the NI buildings into fire compartments and fire cells.

The specific provisions on fire safety requirements for NIs are provided in VATESI regulations:

- Nuclear Safety Requirements BSR-1.8.2-2015, Categories of Modifications of Nuclear Installations and Procedure of Performing the Modifications (2015);
- Nuclear Safety Requirements BSR-2.1.2-2010, General Requirements on Assurance of Safety of Nuclear Power Plants with RBMK-1500 Type Reactors (2010);
- Nuclear Safety Requirements BSR-3.1.2-2017, Pre-disposal Management of Radioactive Waste at the Nuclear Facilities (2017);
- Nuclear Safety Requirements BSR-3.1.1-2016, General Requirements for Spent Nuclear Fuel Storage Facility of the Dry Type (2016);
- Nuclear Safety Requirements BSR-1.4.2-2014, Management of Construction of Nuclear Facility (2014);



## 1. GENERAL INFORMATION

- Nuclear Safety Requirements BSR-1.4.4-2019, Use of the Operating Experience in the field of Nuclear Energy (2019);
- Nuclear Safety Requirements BSR-1.5.1-2019, Decommissioning of Nuclear Facilities (2019);
- Requirements for Nuclear Facility Emergency Electricity Supply Systems Installation and Operation (2001);
- Nuclear Safety Requirements BSR-1.8.5-2018, Commissioning of Nuclear Facility (2018);
- Nuclear Safety Requirements BSR-1.8.6-2019, Technical Maintenance, Monitoring and Examination of Structures, Systems and Components Important to Nuclear Facility Safety (2019);
- Nuclear Safety Requirements BSR-1.3.1-2020, Enforcement of Emergency Preparedness in Nuclear Installations (2020);
- Nuclear Safety Requirements BSR-1.8.11-2021, Supply of Electricity to a Nuclear Facility (2021).

In accordance with the Law on Nuclear Energy, Art. 15 and Art. 35, Paragraph 4, the Ministry of Interior or its authorized institutions shall:

- ensure fire safety of NIs, extinguish fires, rescue people and property, mitigate the consequences of fires and shall direct such activities;
- conduct the state fire safety supervision of NIs;
- coordinate fire safety requirements for the SSCs important to safety of NIs drafted by the State Nuclear Power Safety Inspectorate (VATESI);
- coordinate fire safety training programmes for persons working at NIs and shall participate in testing the knowledge of managing personnel of such NIs.

The Ignalina NPP Unit 2 (now under decommissioning), the Liquid Waste Storage Facility (Building 151) (WFS) and the Bituminized Waste Storage Facility (Building 158) (WSF) were designed, built, installed, and operated for a long time in accordance with the normative documents prepared and in force by the USSR. All these nuclear facilities have been modified in order to ensure that they comply with the Lithuania Republic national fire safety regulatory framework, which has been prepared using international best practice fire safety requirements.

Interim Spent Nuclear Fuel Storage Facility (SNFSF-2, B1 project), Solid Waste Retrieval Facility (retrieval from buildings 157, 157/1, B2-2 project), Solid Waste Management and Storage Facilities (B3/4 project), Cemented Waste Storage Facility (Building 158/2) were designed, built, installed and are in operation, and Ignalina NPP Unit 2 decommissioning is underway in accordance with the normative documents prepared by the Lithuania Republic national regulatory framework.

The fire safety assessment of all these NIs was done during their licensing process. The Law on Nuclear Safety establishes the types of licenses and permits issued by the VATESI. Some activities (hold points) at different stages of the lifetime of a NI require separate authorizations that have to be supported by a safety review and assessment.

For all NIs (Ignalina NPP Unit 2, SNFSF and SWF) evaluated in this report, safety justifications, including their FHA, have been prepared, and VATESI conducted a safety review of these documents and approved these documents only after being convinced, that the fire safety of radioactive materials and SSCs important for the safety of the NIs is justified in these documents. The documents review was carried out by the VATESI with the assistance of technical support organizations competent in the field of nuclear energy fire safety. Every year, the VATESI inspectors carry out inspections of the most hazardous parts of nuclear facilities from a fire point of view in the periods specified in the VATESI inspection programme. The operating organization of NIs must immediately eliminate the violations

## 1. GENERAL INFORMATION

found during the VATESI inspections. The operating organization of NIs must notify the VATESI after the elimination the violations.

NIs fire safety is assessed from the first step of licensing and continues throughout the lifetime. The Law on Nuclear Energy and the Law on Nuclear Safety are the main laws that together with the Law on Radioactive Waste Management and together with the regulations made under the laws establish the licensing system for activities related to nuclear materials or nuclear cycle materials, as well as for NIs of the following life-stages: site evaluation, design, construction, commissioning, operation, and decommissioning. This regulation encompasses, inter alia, the fire protection of all safety important SSCs. The article 22, part 4 of the Law on Nuclear Safety prohibits any activity associated with NI, nuclear materials and nuclear cycle materials without an authorization (licence or permit prescribed in the Law) issued by VATESI.

Some of the steps of the licensing process are divided into several sub-steps. Licences, permits and approvals of the documents are used as authorization steps and sub-steps. It also should be mentioned that some activities during various stages in the lifetime of a NI require separate authorizations that have to be supported by safety review and assessment including fire safety.

VATESI is a competent authority for the licensing of activities involving nuclear materials or nuclear cycle materials or carried out in NIs within the legally defined life-stages. During every stage of a NI a safety evaluation has to be performed and fire safety assessed according to the requirements established by VATESI and other competent institutions.

In case of violations, VATESI is authorized to suspend and revoke licences and permits according to procedures provided by the law.

The Law on Nuclear Safety together with the Regulation on the Issue of Licences and Permits in the Area of Nuclear Energy approved by the Resolution of the Government of Lithuania in 2012, regulates issuance, amendment, suspension, revocation of the suspension and revocation of licences and permits, listed in the Law on Nuclear Safety, as well as supervision of keeping list of documents which have to be submitted for the issue of every type of licences and permits or amendments of a licence or permit. Detailed requirements for the safety documents, including fire safety, are determined in respective nuclear safety requirements and rules issued by the Head of VATESI. These requirements for fire protection are listed above in this section.

The article 25, part 15 of the Law on Nuclear Safety stipulates that a licence shall be issued for an unspecified period until the licence is terminated. Nevertheless, the article 32, part 7 defines for reassessment of safety, including fire safety, at a NI that shall be carried out at regular intervals, no longer that 10 years period over the full operating lifetime of a NI in order to provide evidence that the NI remains fit to continue operation. At this point, after review VATESI may decide to suspend or amend the licence using established procedures.

According to the Regulation on the Issue of Licences and Permits in the Area of Nuclear Energy, VATESI issues the list of finalized licensing documents together with every licence as well supplement the list after issue of a permit. The list is subject to be regularly updated to include the current versions of the documents. The Regulation stipulates that the licensee shall either submit the listed document to VATESI for approval or inform VATESI that the document is amended. Some of the documents in the field of fire protection require VATESI approval before entry into force as determined by the Regulation. The list of the licensing documents has to be kept up to date and maintained until the licence is revoked.

**1.2.2. Implementation/Application of international standards and guidance**

VATESI follows the EU directives, IAEA safety standards, best practice of other countries and transposes them into national legislation.

The main internationally adopted standards, guides and other documents, used in the development of fires safety of NIs, are the following:

- WENRA WGWD: Report Waste and Spent Fuel Storage Safety Reference Levels, Version 2.2, April 2014.
- WENRA WGWD: Report Decommissioning Safety Reference Levels – Version 2.2, 22 April 2015.
- IAEA SRS No. 8, Preparation of Fire Hazards Analyses for Nuclear Power Plants (1998).
- IAEA SS No. 50-P-9, Evaluation of Fire Hazard Analyses for Nuclear Power Plants (1995).
- IAEA SG No. NS-G-1.7, Protection against Internal Fires and Explosions in the Design of Nuclear Power Plants (2004).
- IAEA SG No. NS-G-2.1, Fire Safety in the Operation of Nuclear Power Plants (2000).
- NFPA Standard for Fire Protection for Facilities Handling Radioactive Materials (2008).

## 2. Fire Safety Analyses

### 2.1. Dedicated spent fuel storage facilities

#### 2.1.1. *Spent Nuclear Fuel Storage Facility (SNFSF - 1)*

##### 2.1.1.1. Types and scope of the fire safety analyses

The VATESI regulation requires to perform a FHA for SSCs important to safety. The main important to safety component in SNFSF-1 is the casks with spent nuclear fuel, which is the main barrier limiting the release of radioactivity, and damage of this barrier caused by fire can result in serious radiological consequences.

It is the task of this project to indicate that it is necessary to perform FHA by evaluating the most dangerous design fire scenarios that can cause hazards to casks during their transportation and management in the area of SNFSF-1.

The main purpose of the analysis is to show that the fire occurred in the zone of the cask will not last longer than one hour or that it will be localized by such a time, which guarantees the invulnerability of the cask and the avoidance of radioactive releases.

SNFSF-1 is a complex of buildings and structures designed to store spent nuclear fuel assemblies from the Ignalina NPP. It contains 98 CONSTOR@RBMK-1500 type and 20 CASTOR@RBMK type casks and this facility is fully loaded. It is open concrete site surrounded by shielding wall, the main parameters are: length - 208 meters, width - 65.6 meters, and total area - 13,645 square meters. SNFSF-1 is located on the land allocated for the Ignalina NPP, approximately 750 meters from Ignalina NPP Unit 2.

The SNFSF-1 consists of the following buildings and structures (see Figure 2.1.1-1):

- Open storage area for spent nuclear fuel casks (192).
- Personnel control and heating building (192A).
- Transformer substation (193).
- Production and utility building (194).
- Reservoir building for the controlled drainage system (Structure 195).
- Checkpoint (196).
- Gate control building (196A).

## 2. FIRE SAFETY ANALYSES

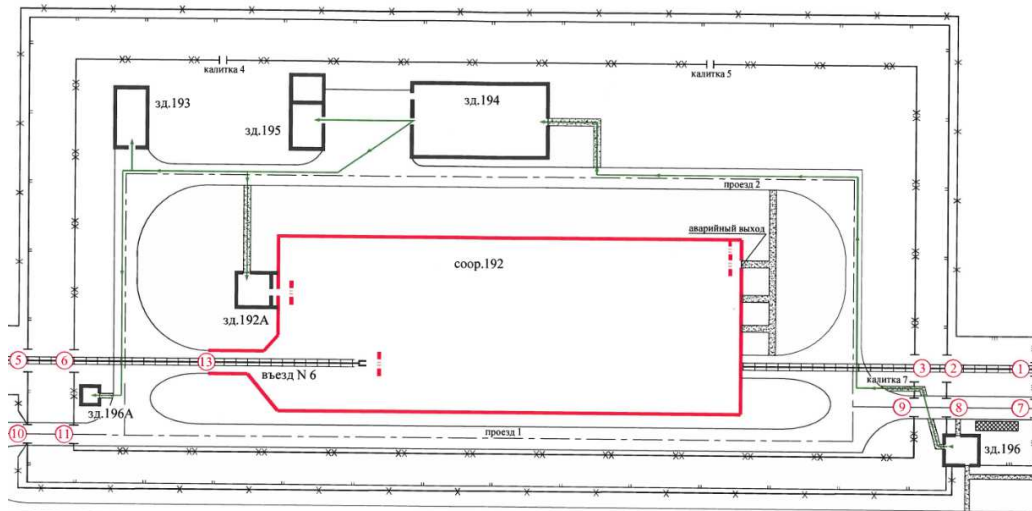

Figure 2.1.1-1. The layout plan of the buildings at the SNFSF-1 site.

The description and characteristics of the buildings and structures of the SNFSF-1:

- Structure 192. Designed for the storage of spent nuclear fuel in CASTOR®RBMK and CONSTOR®RBMK-1500 casks, as well as for equipment for handling the casks. The dimensions of the structure are 35.6x107 m. To reduce ionizing radiation doses at the boundary of SNFSF-1 to permissible levels, a protective concrete barrier with a thickness of 600 mm and a height of 5000 mm, made of precast concrete blocks, is installed around the structure. The storage area for casks consists of a monolithic reinforced concrete slab with a thickness of 500 mm, and the dimensions are 23.5x105 meters, laid on a specially prepared foundation. A GK-100 gantry crane with a lifting capacity of 100 tons is used for transportation and technological operations with cask. The crane lifting mechanism is equipped with a manual lowering mechanism, allowing the lowering of loads weighing up to 100 tons in case of a power failure. An under-crane rail track, 101 meters in length and 23.6 meters in width, is installed for moving the GK-100 crane along the storage slab. Special support stands are constructed for placing casks on the slab, with six stands for each cask. The structure has a combined railway and automobile entrance. A railway track for transporting casks is embedded flush with the floor of the slab. At the end of the track, there is a rail stop for the auto-coupler. Personnel access to the structure is through Building 192A, which is directly adjacent to the west wall of Structure 192. An emergency exit gate is provided in the eastern wall.
- Building 192A. Personnel control and heating building. Single-story. The dimensions are 6x6 m. It is intended for organizing personnel access to Structure 192 and for temporary accommodation of personnel during breaks.
- Building 193. Transformer substation building. Dimensions are 6x12 m. It houses a two-transformer substation for supplying electricity to SNFSF-1 consumers.
- Building 194. Production and utility building. Single-story. Dimensions are 36x15m. According to radiation safety requirements, the building is divided into two parts (“clean” and “contaminated”) by a sanitary checkpoint (rooms 122–130). The building contains personnel rooms, storage rooms, a workshop, radiation safety control rooms (106, 135, 136) with corresponding equipment, a sanitary checkpoint with a shower room, a heating unit, and

## 2. FIRE SAFETY ANALYSES

ventilation system rooms. There are two entrances to the building, one from the “clean” and one from the “contaminated” SNFSF-1 areas. Ventilation of the production and utility rooms is provided by forced air intake and exhaust ventilation systems.

- Building 195. Reservoir building for the controlled drainage system. Single-story, with an underground part. The dimensions of the underground part are 6x15 m, and the above-ground part are 6x9 m. It consists of a submerged reservoir with a useful volume of 80 m<sup>3</sup> and an adjacent semi-submerged pump station. The pump station is equipped with two groups of pumps. The first group is for pumping rainwater from the reservoir, and the second group is for pumping shower water from the control tank. All equipment is located at an elevation of -4.00 m, which is the floor level of Building 01. The rainwater collection tank is underground and is adjacent to the north side of the building. The bottom of the tank is at an elevation of -4.00 m.
- Building 196. Checkpoint. Dimensions are 9x6 m. Access to the SNFSF-1 area is through this building (checkpoint). The building is divided into an entrance zone, a inspection zone, and a guard room.
- Building 196A. Gate control building. Dimensions are 3x3 m. It is intended for housing gate control panels for railway and emergency automobile transport entry and exit gates.

#### 2.1.1.2. Fire phenomena analyses: overview of models, data and consequences. Main results.

In the SNFSF Safety Analysis Report (SAR) for the storage facility, one of the initial events for design accidents is considered to be a fire. In the SAR for the CASTOR RBMK cask, ArchPD-0745-68754, it is calculated that the cask can withstand a fire with a flame temperature of 600°C for 1 hour. In the SAR for the CONSTOR RBMK-1500 cask, ArchPD-0745-67384, it is shown that, in addition to withstanding a fire for 1 hour with a flame temperature of 600°C, it can also withstand exposure to a fire with a temperature of 800°C for 0.5 hours. Both types of casks remain sealed after the fire, and there is no reduction in the protective properties of the casks or its components below acceptable limits. The container closures remain in working condition and are capable of performing their functions.

In addition to the impact on the cask, the fire also has a high-temperature effect on the concrete structures surrounding the casks. As shown in the SAR for CASTOR®RBMK cask the surface temperature of the concrete slab after the fire exceeds the permissible temperature for concrete, which is 70°C, by only 1.2 degrees. Such a slight increase will not have a significant impact on the condition of the concrete structures in the building where the casks with spent nuclear fuel are stored.

Given that there are no combustible materials to sustain a fire in Structure 192 (all components of the structure are made of metal and concrete), a fire of such intensity cannot occur spontaneously in Structure 192. The occurrence of such a fire is only possible in the event of the initial design accident considered in the storage facility project, which is the impact of an aircraft crash. It is assumed that the aircraft's tanks should contain a flammable substance, the ignition of which would cause a fire.

The SAR demonstrates that a fire with the specified parameters in Structure 192 (the location for storage casks) will not lead to the loss of safety functions of the SNFSF-1 SSCs important to safety.

However, the project considers permissible fire loads on the cask storage site (a vehicle filled with fuel, maintenance work). In case of their ignition, the fire load will be much less than what the casks were designed and tested to withstand. A fire on the storage site outside the building also does not poses a real threat since the casks are located at a significant distance from the source of the fire.

Inside Structure 192, there is a GK-100 gantry crane with a lifting capacity of 100 tons, designed for performing transport and technological operations with casks. The crane structures are entirely metallic. Therefore, the cause of fires on the crane can only be a short circuit in the electrical equipment of the

## 2. FIRE SAFETY ANALYSES

crane during its operation. These fires will not lead to a fire but only to localized burning of electrical cables. The crane operator, after de-energizing the crane, can quickly extinguish the fire using a fire extinguisher located in the control cab. The crane lifting mechanism is equipped with a manual lowering mechanism, which will allow lowering a load weighing up to 100 tons in case of a power failure. Therefore, if the crane is lifting/moving a cask at the time of ignition, it can be lowered to the floor of the storage area using the manual lowering mechanism. Burnt electrical cables can be easily replaced with functional ones. Thus, fires on the GK-100 crane do not lead to the loss of safety functions of the SNFSF-1 structures and systems important to safety.

Based on the Fire SAR for SNFSF, At-4233(3.107), conducted in 2017, it can be stated that a fire at SNFSF-1 is a highly unlikely event. Only local fires are possible, which can be easily contained and extinguished using primary firefighting equipment. If the fire duration exceeds 20 minutes, it can be extinguished by the arriving VFRS. Importantly, the safety-critical functions of SNFSF-1 are not compromised.

#### 2.1.1.3. Periodic review and management of changes

The review of fire safety analysis is carried out within the framework of the Periodic Safety Review every ten year. The last PSR for SNFSF-1 was performed in 2015 [5.34].

The Safety Analysis for storage cask CASTOR RBMK, CONSTOR RBMK-1500 was performed in 2006. [5.32, 5.33].

The last Fire Safety Analysis for SNFSF-1 was performed in 2016 [5.35].

The impact of modification on fire safety SSCs important to safety is analysed in planning justifying modification.

#### 2.1.1.4. Regulator's assessment and conclusions on fire safety analyses

VATESI reviewed the SAR of SNFSF-1 submitted by the SE Ignalina NPP, in which the fire safety of SNFSF-1 was justified and in 2000, VATESI issued an operating license for 5 years. Periodic safety assessment of SNFSF-1 was carried out in 2004 and after that VATESI issued a license for an indefinite period. Ignalina NPP submitted SNFSF-1 PSR report to the VATESI in 2016. VATESI review RSR report and requested additional FHA to the extent specified in VATESI's 2014 approved nuclear safety requirements BSR-1.7.1-2014 "Fire safety of safety important structures, systems and components". FHA confirmed that the occurrence of a large-scale fire at the SNFSF-1 is a very unlikely, and in case of small local fires sufficient functionality of important to safety SSCs would be ensured by applying additional compensatory measures. SE Ignalina NPP has also prepared additional instructions for ensuring fire safety and fire extinguishing plans for SNFSF-1.

VATESI conducts fire safety inspections at the SNFSF-1 once every four years in accordance with the VATESI inspection program. During the last inspection, which was carried out by VATESI in 2021, violations and non-conformities with good practice were not identified.

VATESI reviewed the SNFSF-1 fire SARs submitted by Ignalina NPP and did not found deficiencies for them.

### 2.1.2. *Interim Spent Nuclear Fuel Storage Facility (SNFSF - 2)*

#### 2.1.2.1. Types and scope of the fire safety analyses

The VATESI regulation requires to perform a FHA for SSCs important to safety. The main important to safety component in SNFSF-2 is casks with spent nuclear fuel, which is the main barrier limiting the release of radioactivity, and damage of this barrier caused by the fire can result in serious radiological consequences.

## 2. FIRE SAFETY ANALYSES

It is the task of this project it is indicated that it is necessary to perform FHA by evaluating the most dangerous design fire scenarios, which can cause hazards to casks during their transportation and handling in the area of SNFSF-2.

Systematic FHA for all building sections of the SNFSF-2 including the Gate House was performed. Based on the combustible inventory in the different compartments specific fire scenarios were analysed to calculate the duration and impact of potential fires. This shall show that the fire resistance of the building walls and doors, etc. is sufficient to prevent unacceptable spreading of the fire. Also, the potential sources of ignition and the provisions for fire extinguishing were taken into account.

The main purpose of the analysis is to show that the fire occurred in the zone of the cask will not last longer than one hour or that it will be localized by such a time, which guarantees the invulnerability of the cask and the avoidance of radioactive releases.

SNFSF-2 is located on a land allocated for the Ignalina NPP. SNFSF-2 is a separate facility and does not have any interfaces with SNFSF-1, where CASTOR® RBMK-1500 and CONSTOR® RBMK-1500 are stored. The SNFSF-2 site is located approximately 0.5 km to the south of the existing INPP security fence. The approximate site dimensions are 300 m × 100 m. The ISFSF construction site is now a recultivated (planted with pine seedlings) former soil buffer dump. The SNFSF-2 site is connected to the Ignalina NPP via a railway and road. The transfer of the casks to the ISFSF is performed by rail transport.

The transporter arrives at the Reception Hall with the cask loaded and closed with the primary lid and protective plate. An overhead crane transports the cask to a CSS, where the seal plate and secondary lid are welded onto the cask. After the required checks, the cask is transported by the overhead crane to the Storage Hall and the cask is vertically placed in the storage location. The layout of the main storage building is presented in Figure 2.1.1-2.

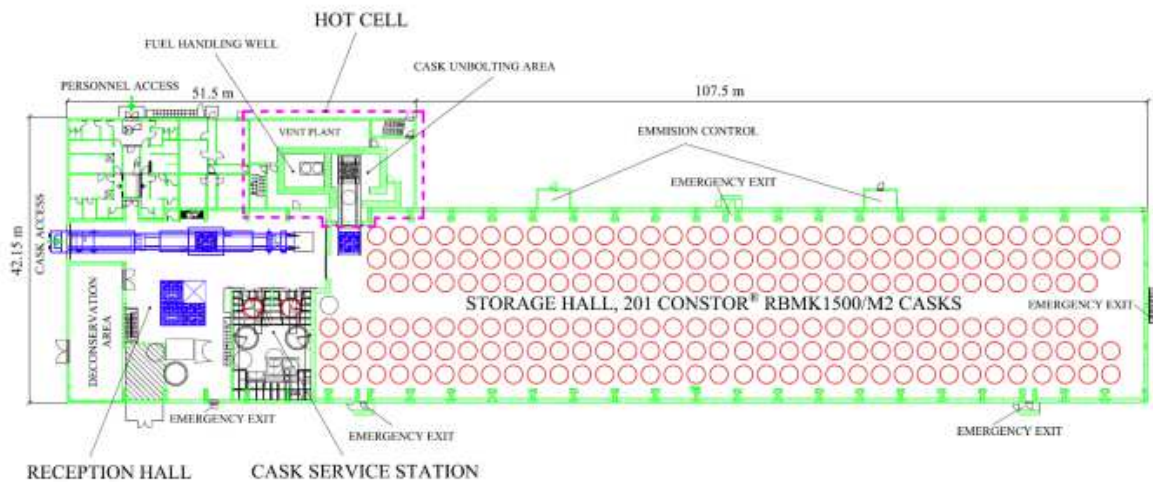

Figure 2.1.1-2. Layout of the main storage building of SNFSF-2

### 2.1.2.2. Key assumptions and methodologies

The objective is to present a model gallery description to be used as an introduction and guidance for further detailed analysis of rooms at the SNFSF-2.

#### Rate of heat release

The effect  $Q$  can be calculated using the following formula:



## 2. FIRE SAFETY ANALYSES

$$Q = m \cdot \Delta h_c \cdot A \cdot \chi$$

where  $m$  - the fuel that evaporates from the surface ( $\text{kg}/\text{m}^2 \text{ sec}$ ),  $\Delta h_c$  - the energy content in the fuel ( $\text{MJ}/\text{m}^3$ ),  $A$  - the burning area ( $\text{m}^2$ ),  $\chi$  - the combustion efficiency (for oils normally 60-70%).

### Gas temperature

The temperature in the gas layer generated by the fire was considered. How this was done depends on the fire scenario's relation to the room configuration but some kind of computer model is often needed. When evaluating the gas temperature, a recommended first step is to use a computer zone model to model the fire. This gives sometimes enough information to decide if critical conditions can occur, but not always. If great turbulence is expected in the room or if the fire is very small compared to the room volume the zone modelling result have to be verified by other methods, like CFD-modelling (Computational Fluid Dynamics) or complementing hand calculations.

The input that is required to a zone model is the design fire curve, the room configuration, the ventilation conditions, and the ambient conditions in the room. The output given from the model is for example the gas temperature in the upper and lower layer, gas layer height and rate of heat release. A way to decide if the zone model is valid for the specific scenario is to compare the gas temperatures in the upper and lower layer. If these temperatures do not differ by more than  $10^\circ\text{C}$ , then the zone model cannot be used to evaluate the gas temperature and layer height because the difference in density will then be too small to create separate layers.

### Zone models

Zone models are often used to calculate the gas temperature and the height of the gas layer as a function of time.

Zone models describe the influence of fire in an enclosed room by using a limited number of zones or control volumes. The most common model is the so-called two-zone model, which divides the room into two distinct control volumes; one upper control volume near the ceiling called upper layer, consisting of burnt and entrained hot gases and one cold lower layer which contains fresh air.

Semi-empirical equations for mass, momentum, energy and chemical species are solved separately for upper and lower layer respectively and transition of mass and energy between the zones is accounted for by the use of a plume model. In some models, the plume appears as a third "layer". In other models the influence of the plume is ignored. The transient plume effects, like the temporal build up of the plume and the time for the hot gases to move from the core of the fire in the lower layer to the upper layer, are then left without consideration. The two layers, or control volumes, are assumed homogenous and temperature, density, pressure, and etc. can be considered to represent average values over the zones.

A large number of experiments have been performed in order to verify and evaluate the validity of zone models and to identify the uncertainties. It is a matter of course that there are uncertainties embodied in these models and that in some cases the errors are of a magnitude that clearly makes the zone model inapplicable.

In large and/or complex areas the CFD model, described below, is therefore recommended. The zone model should not be used if it generates a temperature difference between the two layers of less than  $10^\circ\text{C}$ , because no zones can be expected to exist under these conditions.

CFAST (Computational Fire Growth and Smoke Transport) Zone model:

Basis/scope: Estimating fire growth and smoke transport.

## 2. FIRE SAFETY ANALYSES

Input: Room configuration, heat release rate, fire growth constant, ventilation condition, ambient conditions, ceiling/roof/floor materials etc.

Output: Gas temperature, layer height, radiation, detector activation time, wall temperatures etc.

Formulas/theory basis: Enthalpy and mass transport between layers, Zukowski plume model.

Application area/experiences: Single room fire, multiple room fire.

Limitations/assumptions: Not valid for large rooms or atria, obstructions cannot be considered.

Validation made/required: Comparisons with experimental results have been done.

Certification/users/experience: Basic fire protection engineering knowledge.

An example of a computer zone model is CFAST (or sometimes called FAST). FAST can handle a maximum of 15 rooms, mechanical ventilation and different vent flows. FAST requires a various number of inputs in order for the calculations to be as exact as possible. These inputs could be divided into the following categories:

1. Ambient conditions (temperatures - internal and external, wind speed, pressure, reference height etc.).
2. Geometry (compartment dimensions, drawing over building, floor elevation, vents etc.).
3. Fans and ducts (outlet/inlet location and size, duct material, size and length, fan capacity etc.).
4. Mechanical smoke ventilation. If specific smoke ventilators the capacity and operating temperatures must be known.
5. Compartment thermal properties (boundary properties like material and thickness etc.).
6. Fire specification (location, heat of combustion, heat release rate i.e. the design fire).

CFD (Computational Fluid Dynamics) models

If the zone model is decided not to be enough to evaluate the consequences a CFD-model can be used. This is a very complex computer model where the room is divided into small control volumes. CFD model is appropriate to use when the:

- I. Room is large.
- II. Temperature differences between the gas layers are small.
- III. Turbulence in the room is great.

The input to a CFD model is for example the heat release rate and the output from the model is the temperature in each of the control volumes and the smoke movement.

Field modelling using CFD: Field modelling is often used in large or complex areas to calculate the gas temperature and smoke movement in different areas of the room. Examples of CFD models are FLOW-3D (British Harwell Laboratory), JASMINE (British Fire Research Station), LES (NIST Building and Fire Research), and KAMELEON (Norwegian SINTEF NBL and Sandia National Laboratory), SOFIE (University of Lund).

Basis/scope: Estimating smoke movement and gas temperatures.

Input: Room configuration, obstructions, heat release rate, fire growth constant, ventilation condition, ambient conditions, etc.

Output: Temperature profiles, smoke movement etc.

Formulas/theory basis: Exchange of mass, momentum and energy between small control volumes (Navier-Stokes equation).

## 2. FIRE SAFETY ANALYSES

Application area/experiences: Can be used in all kinds of areas.

Limitations/assumptions: Dependent of each CFD model.

Validation made/required: Some experimental studies have been done.

Certification/users/experience: Input files demands expert knowledge.

When using field modelling, a domain in space is first defined. The simulation will then be carried through in this domain and its proportions are determined by the size of the object that is to be simulated. The domain is divided into a large number of small control volumes, which in addition can be defined as being walls or obstacles of some kind, or simply to consist of fluid space or air. In this way, the actual geometry that is to be simulated is built up inside the computational world; the domain, defined earlier and relevant boundary conditions can be predetermined including restrictions and limitations on the solution. CFD technique, Computational Fluid Dynamics, is then applied in order to solve a set of non-linear partial differential equations derived from basic laws of nature. To be able to simulate the flows of nature various models has to be incorporated. In the case of fire, a combustion model is used to simulate the course of combustion, a turbulence model has to be included for the prediction of the buoyancy driven turbulent flow as well as a radiation model to simulate the thermal radiation. There are also many additional sub-models that can be included such as fire-spread model and soot model etc.

To define, solve and present result of a problem the CFD model uses a pre-processor, a solver and a post-processor. The pre-processor is used to define the actual problem and includes grid generation, boundary conditions, selection of calculation models to be used and what output is required etc. The solver uses the input data to find a solution to the problem. Because the equations of conservation are non-linear partial differential equations they have no simple analytical solutions, to solve these equations the field models use different kinds of numerical techniques. The solutions obtained are then examined and presented using some post processor software.

The accuracy of a simulation depends for example on factors such as the grid resolution and the specific models being used. Field modelling is a powerful tool given that the engineer is well aware of the limitations and uncertainties in the used software, because of the large and hard work effort coming with the CFD modelling this is recommended only in complex and/or large areas where the zone model is not appropriate to be used.

### **Plume temperature**

When the redundant paths are located in the absolute vicinity of the fire a plume model was used to verify if the plume can affect the paths.

The plume temperature can be calculated using hand calculations or computer programs such as zone models or CFD models. Hand calculations different plume model depending on the size of the fire is used. The output from the plume models is the temperature in the plume at different heights and the width and height of the plume. If the plume is shown to involve the redundant paths the plume temperature was compared with the damage thresholds.

There are different plume models available to use. The different models are suited for different situation.

In this section only the Heskestad plume model (this model was used when performing FHA for the Ignalina NPP Units 1 and 2; since SNFSF-2 contains very similar equipment (e.g. cables, electrical motors and cabinets), this model was also used for SNFSF-2) will be presented in more detail.

The following equations are in the Heskestad plume model used to calculate plume mass flow at different height  $z$ , above the fire.

For  $z > L$ , i.e. plume mass flow rate above the flame height:

## 2. FIRE SAFETY ANALYSES

$$\dot{m}_p = 0,071 \dot{Q}_c^{1/3} (z - z_0)^{5/3} + 1,85 \cdot 10^{-3} \dot{Q}_c \quad (\text{kg/s})$$

For  $z < L$ , i.e. plume mass flow rate at or below the flame height:

$$\dot{m}_p = 0,0056 \dot{Q}_c \frac{z}{L} \quad (\text{kg/s}),$$

where  $\dot{Q}_c$  is the convective energy release rate, which is normally around 0,7 ·  $\dot{Q}$ .  $z_0$  is the virtual origin of the fire which depends on the diameter of the fire and the total heat release rate. Figure 2.1.1-3 shows the plume properties discussed in this section.

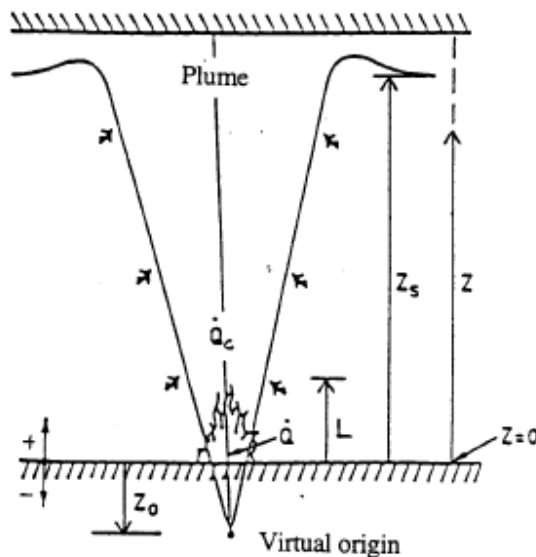

Figure 2.1.1-3. Main plume properties discussed in this section

The mass plume rate increases with the height  $z$  above the floor. The mass plume rate could easily be converted to volume plume rate.

Heskestad presents in his plume model also an equation to calculate the plume centerline temperature. The equation below is used to calculate the plume centerline temperature.

$$\Delta T_0 = 25 \left( \frac{\dot{Q}^{2/5}}{(z - z_0)} \right)^{5/3} \quad (^\circ\text{C})$$

#### **Heat of radiation**

Heat of radiation can be caused by the flame but also by a hot gas layer. A hot gas layer can radiate both to a component placed at floor level but also at a component placed in the gas layer itself.

The heat of radiation from the flame to the safety paths shall always be calculated unless this obviously is not a threat.

The radiation from a flame can be calculated treating the flame as a rectangle and using configuration factors. The worst case of heat of radiation from a flame is calculated assuming a flame height corresponding to the maximum heat release rate though less than the height of the room.

The input to the calculations is basically flame height, flame width and distance from flame to object. The output is heat of radiation to a point in kW/m<sup>2</sup>.

Models for calculating heat of radiation can also be included in different computer zone models and it can also be calculated using field models. When the time to critical conditions is an interesting parameter to the problem the computerized models must be used.

The configuration factor model treats the flame as parallel rectangles. The radiative heat flux is calculated to a point perpendicular to the flames. To calculate the radiation from the middle of the rectangle the flame is divided into four rectangles each contributing to the heat flux at different distances (Figure 2.1.1-4).



Figure 2.1.1-4. Scheme to calculation heat of radiation

The heat flux to the target can then be calculated as follows:

$$\dot{q} = \Phi \cdot \sigma \cdot \varepsilon \cdot (T_1^4 - T_2^4),$$

where  $\Phi$  - the configuration factor,  $\sigma$  - Boltzman's constant ( $5,67 \cdot 10^{-8} \text{ W/m}^2\text{T}^4$ ),  $\varepsilon$  - the emissivity,  $T_1$  - the flame temperature ( $\sim 1200\text{-}1500\text{K}$ ),  $T_2$  - the target temperature ( $\sim 300\text{K}$ ).

The configuration factor can be calculated using following equation:

$$F_{\text{fl-2}} = \frac{1}{2\pi} \left\{ \frac{X}{\sqrt{1+X^2}} \tan^{-1} \left[ \frac{Y}{\sqrt{1+X^2}} \right] + \frac{Y}{\sqrt{1+Y^2}} \tan^{-1} \left[ \frac{X}{\sqrt{1+Y^2}} \right] \right\},$$

where  $X = L_1/D$ ,  $Y = L_2/D$ ,  $L_1$  - flame width (m),  $L_2$  - flame height (m),  $D$  - distance to object (m).

When the radiation is calculated from the middle of the flame,  $L_2$  is the total flame height divided by two (2) and  $L_1$  is the flame width divided by two (2). The total configuration factor is then calculated as:

$$\Phi = 4 \cdot F_{\text{fl-2}}.$$

The heat of radiation from a hot gas layer is a more complex procedure and will not be described in this document.

### Flame contact

When the redundant paths are located above the place of fire start the possibility of direct affect from the flame must be considered. This can be done by calculating the flame height and compare this with the location of the paths.

The input for the flame height calculation is the maximum heat release rate of the fire and the diameter of the fire area. The output is the height of the flame only.

## 2. FIRE SAFETY ANALYSES

The mean height of the flame according to the Heskestad plume can be calculated using the following formula:

$$L = 0,235 \cdot Q^{0,4} - 1,02 \cdot D,$$

where  $D = \sqrt{4A/\pi}$  is the diameter of the fire source (m), Q is total energy release rate (kW).

**Visibility**

When personnel have to make actions in the room of the fire the visibility is essential.

The input for the calculation of the time to critical visibility conditions are the smoke potential of the material (ob m<sup>3</sup>/m), the amount of burnt material (g), the volume of the room (m<sup>3</sup>) and the mass loss rate of the burning material.

The optical density is calculated by using the following equation:

$$\frac{D}{L} = \frac{D_0 \cdot W}{V} \text{ (dB/m),}$$

where  $D_0$  is the smoke potential of the material, W is the amount of burnt material (g) and V is the volume of the room.

The equation is then solved for  $D/L = 1$  dB/m giving the amount of burnt material to cause a visibility of 10 m could be calculated. The time to critical visibility conditions can then be calculated knowing the mass loss rate of the material. The visibility conditions can also come as an output from a CFD calculation.

**Detection and alarm**

A general engineering assessment of the detection system was made for ensuring capability and reliability credited in other analyses above. The following factors were checked and qualitatively evaluated:

1. Adequacy in accordance with standards, experience and conditions.
2. Reliability.
3. Fire safety of the rooms in which the system is located so that a fire can't destroy the Fire Protection system itself.
4. Manual actions credited for full function.

**Manual fire fighting analysis**

To be able to determine whether manual fire fighting can prevent a fire from disabling redundant equipment or cables, a manual fire fighting analysis is performed.

**Main assumptions**

Compartments with low fire load and lack of potential ignition sources (WC, washrooms, anterooms, entrances, some corridors etc.) due to low fire occurrence possibility are not analyzed in this report.

It is assumed that only one fire can start at a time.

The primary lid is bolted to the cask body and sealed by means of an elastomer ring. Elastomer sealing ring is made of silicone rubber and is used for the leak-tight containment of the cask. Damage of this ring could cause release of activity from the cask.

## 2. FIRE SAFETY ANALYSES

It can be concluded that sealing ring temperature reaches a value of 158 °C when outside temperature (i.e. temperature in case of fire) is 800°C / 0.5 h and 151°C - when 600°C / 1 h. The operating temperature of elastomer sealing ring (which is made of silicon rubber) is from -70°C to +200°C.

The mentioned temperatures in the sealing ring were determined when the cask is with complete set of lids (primary lid, seal plate and secondary lid). Besides cask is always in vertical position (lids are on top of the cask (at. approx. 4.5 m)) therefore it is assumed that cask is designed to withstand temperatures of 600°C / 1 h, or 800°C / 0.5 h.

The possibility of transient fire loads is not considered. Transient fire loads will be controlled by operating procedures, and will never be large enough to approach the design basis fires.

### Damage thresholds

Equipment and components can be affected in different ways by a fire. In the literature, the temperature and heat radiation effects (thermal heat flux) are mainly discussed, because these are the only effects that can be evaluated in a quantitative way.

Damage thresholds for typical equipment are given in the Table 1-1 and for personnel in Table 1-2.

Table 1-1. Damage threshold for different equipment

Equipment	Critical gas temperature, °C	Critical thermal heat flux, kW/m <sup>2</sup>
Pumps	200-250	8-18
Electrical motors	200-250	8-18
Compressors	200-250	8-18
Electrical equipment	60-70	8-10
Cables	200-250	8-18

Table 1-2: Damage threshold for personnel

Name	Value	Comment
Critical gas temperature, °C	60	-
Critical gas layer height, m	1.6+0.1H	H – height of the room, m
Thermal heat flux, kW/m <sup>2</sup>	37.5*	100% lethality in 1 min
Thermal heat flux, kW/m <sup>2</sup>	25.0*	100% lethality in 1 min and significant injuries in 10 seconds
Thermal heat flux, kW/m <sup>2</sup>	12.5*	1% lethality in 1 min
Thermal heat flux, kW/m <sup>2</sup>	4.0*	Can stand for short times (10 – 20 min)
Thermal heat flux, kW/m <sup>2</sup>	2.4*	No influence

\* Values for unprotected skin.

Long-time (> 30 min.) tolerable temperature for human is 60 °C, and tolerable heat flux (~30 s.) is 2.5 kW/m<sup>2</sup>

#### 2.1.2.3. Fire phenomena analyses: overview of models, data and consequences. Main results.

##### Gate House

This is security and administration building (it is a separate building, located about 30 m from SNFSF-2). This building is also divided into few fire compartments.

## 2. FIRE SAFETY ANALYSES

Transporter and truck are separated by distance (passive fire protection by separation) (distance from the building to the transporter (cask) is 13 m, to the truck 3.5 m) from the building.

Analysis showed that:

- The resistance of fire compartments with 250 mm thick concrete walls is very high (design fire resistance is REI90).
- The fire resistance of walls between compartments in fire compartment is approx. 1 hour.
- Fire times in fire compartments are much shorter than the resistance of fire compartment boundaries.
- Fire walls separate the inspection area from the Gate House, therefore fire spread from the building to inspection area is likely not occur.

To prevent fire or smoke spreading between fire compartments:

- Fire and smoke protective doors with self-closing mechanisms are installed in fire compartments.
- Ventilation ducts are equipped with fire dampers (fire resistance EI60 and EI30).
- In case of fire, it is detected in its early phase due to response of the fire detection system.
- The building is equipped with a sufficient number of manual fire extinguishing means.
- As people are always present (three shifts) in the building, the activities in manual fire suppression are immediate (continuous presence of people also enables early fire detection in case of failure of the fire detection system);
- Fire walls separate the inspection area from the Gate House, therefore fire spread from this floor to inspection area will not occur.

Taking into account all mentioned features it is practically impossible that fire can spread from Gate House to truck or transporter/cask and damage them.

#### ***Truck and Transport Train Inspection Area***

The Gate House consists of two parts – the administrative building where offices and other compartments are located and the Truck and Transport Train Inspection Area.

The following fire scenarios were analysed:

- Scenario 1, Fire in the train.
- Scenario 2, Fire in the truck.

Since floor of the Truck and Transport Train Inspection Area is at level -0.00 m and floor of the Gate House is at level +0.30 m it was considered that fuel will not flow into the Gate House.

Calculations showed that even without human intervention design fires do not spread so much or do not last for more than one hour.

Calculations indicate that highest average temperature of about 330 °C can be reached in the fire area in the worst design fire scenario (i.e. the leak of 1000 l diesel fuel from the train). Due to turbulence, the temperature will not be distributed equally over the entire area. In some parts it will be higher and, in some parts – lower. But in any case, the cask will not be damaged, because the duration of highest temperature exposure can be approximately a few minutes..

Since the area is always manned during inspections a fire is detected almost immediately and successful fire suppression requires a fast response, and that the personnel handle the extinguishers well.



## 2. FIRE SAFETY ANALYSES

Powder extinguishers should be used for fire fighting. Calculations have shown that for the worst design fire scenario about 60 kg of powder should be used, therefore it is necessary to foresee an installation of a fire extinguisher of such capacity.

The train / truck is checked regularly in order to reduce the possibility of fire occurrence.

The VFRS are always called (via the Emergency Response Centre by phone) and it takes about 15 minutes (since team is located in a distance of about 6 km) for them to come to the SNFSF-1. The fire source in the inspection area can be accessed via two external gates of the inspection area.

**Reception Hall**

After inspection at the Gate House the cask is transported to the Reception Hall.

The cask reception area is separated from the other technical and staff rooms by fire walls and fire doors. Walls of cask reception area are masonry and reinforced concrete with a thickness of about 400 mm. The floor of the cask reception area is made of strong concrete (i.e. concrete class according to LST EN 206-1:2002 (Concrete – Part 1: Specification, performance, production and conformity) is C30/35)) and this was done in order that the concrete could resist all credible fires without failing in a way which might threaten a cask.

The elements of structures, insulation and finishing are made of non-flammable materials.

The assessment of necessary fire protection degree of structures of ISFSF building is presented in “Fire safety concept”. According to this, the main supporting structures have design fire resistance R90. The design of the reception hall complies with this requirement.

It is foreseen that a staff of about 43 persons are operating in three shifts (i.e. about 12-15 persons in one shift).

Casks in the area of the Reception Hall are transferred by crane. The same crane transfers the casks to the Cask Service Station and to the Storage Hall.

Not only the crane, but a few other devices in the Reception Hall use electrical power: traverses, tilting device, shielding sliding gate, double wing doors, etc., which can cause fires at the Reception Hall.

The following fire scenarios were analysed:

- Scenario 1, Fire in the main crane.
- Scenario 2, Fire in cables.
- Scenario 3, Fire in the train.
- Scenario 4, Fire in other parts of the Reception Hall. (There are also few devices using electrical motors power. Calculations in Scenario 1 showed that even in case of large-scale electrical motor fire, the fire duration is less than 20 minutes. Motors used for sliding gates, double wing doors, movable working platforms, forklift, etc. are much smaller, so the fire duration and exposure on the cask will be negligible in case of fire. Besides, due to huge compartment volume the flames will entrain “cold” air and high temperatures are unlikely to occur in the Reception Hall).

**Conclusions**

Reception Hall is equipped with manual call point (for immediate notification about fire occurrence), fire detectors and manual fire extinguishers.

A fire in electrical equipment (electrical cabinets / electrical motors) due to large compartment volume and short fire time (up to 20 minutes) do not cause general temperature rises endangering other equipment or cask integrity. However, crane fire calculations show that fire spread is possible between crane electrical equipment, but very conservative assumptions were made during these calculations.

## 2. FIRE SAFETY ANALYSES

Conservative assumptions were also made for the fire calculations in the cables. The results show that the fire time can be about 43 minutes and the conservative evaluation of temperature in the Reception Hall (i.e. in case of ideal adiabatic case) can reach about 185°C (much below than the temperature analyzed for cask integrity). However, cables have flame retardant insulation and they will not burn with an open flame.

Evaluation of fire fighting means showed that any design fire of electrical equipment could be suppressed using extinguishers located in the Reception Hall.

Another scenario involved fire in the train. The modelling showed that the maximum temperature during a design fire in the fire zone can reach about 355°C after approx. 1700 s (28 min) from the fire originating (the modelling also showed that the layer height where such temperature is possible could be about 5 m thick from the ceiling (i.e. from 7 m)) and in the lower part of this layer the temperature will be lower). Then the temperature starts to decrease. Average temperature in the rest part of the Reception Hall is much lower (max. value is about 150°C).

Powder extinguishers should be used for train fire extinguish. Calculations show that about 60 kg of powder should be used (assuming 100 % efficiency) to extinguish a fire of 26 418 kW (and assuming that such fire extinguisher will be able to spray the powder with a rate of not less than 0.5 kg/s). Two (each of 50 kg of extinguishing media) fire extinguishers are installed for extinguishing possible train fire. If fire will be noticed immediately it is possible that it can be controlled by personnel using manual fire extinguishers. But train stops in rather confined area, therefore it might be problematic to reach fire source, since temperature grows rather fast (~ 14°C/min), and smoke production might be intensive.

#### ***Deconservation Area***

In the Deconservation Area the operations of removal of the protective preservation of seal plate, secondary lid, etc. are performed.

The Deconservation Area is like a separate fire compartment. It is separated from the Reception Hall by thick firewalls (400 mm) of reinforced concrete and from the outside it is separated by 300 mm reinforced concrete walls. The fire resistance of these walls is at least 1.5 hours.

There are two openings – doors to the Deconservation Area. One of them is smoke-and fire protective (fire resistance EI90) leading to the Reception Hall. The other door leads to the outside (this door is not fire protective).

The inside surfaces of the compartment are made of non-flammable materials.

The following fire scenarios were analysed:

Scenario 1, Fire in monorail crane.

Scenario 2, Fire in wash benzine / acetone.

Scenario 3, Others fires.

Analysis showed that:

- Room internal walls and doors leading to the reception area, where the cask can be temporarily stored) are fire protective REI90 and EI90 respectively (the external wall has also the same fire protection degree as internal walls, however doors installed in external wall are not fire protective and there is low quantity of potential ignition sources in the room);
- The inside surfaces of the compartment are non-combustible;
- The design fire durations are much shorter than the resistance of the fire barriers;
- Room is equipped with a fire detection system;

## 2. FIRE SAFETY ANALYSES

- Only small amount of benzine / acetone is used (1 l) in leak and break proof tanks;
- The number of manual fire fighting means is sufficient to suppress any design fire;
- Ventilation system is equipped with fire dampers to avoid fire spread. This ventilation system is launched according to signals from the gas analyzer (whose sensors react to the lower explosion limit of 20 % concentration of petrol and acetone steam);
- During operations the personnel is present in the room.

It is impossible that fire can spread from Deconservation area to the Reception Hall and damage a cask or any other equipment.

***Cask Service Station***

The cask is transferred from the transporter to the Cask Service Station using the building crane (Reception Hall is linked to the north, east and west of the current compartment). When the cask is in the service position the door and the ceiling sliding part of the Cask Service Station (CSS) are closed. It means that this compartment belongs to a “tight” compartment.

The following fire scenarios were analysed:

- Scenario 1, Fire in wash – benzine / acetone.
- Scenario 2, Fire in the lid handling crane.
- Scenario 3, Other fires

**Conclusions**

Analysis revealed that only small quantities of benzine /acetone (only 1l in tight and break-proof tanks) are temporary brought to CSS. Calculations showed that the thermal radiation from the flames during design benzine / acetone fire is high in short distances and it can be problematic to access the flame for extinguishing. Since benzine / acetone fire duration is very short, the exposure on people and the equipment located in the room is also short and due to large room volume (~ 1730 m<sup>3</sup>) high temperatures will not be reached.

Fire in the crane will not spread to the other equipment and will not damage it, because even conservative calculations showed that heat fluxes are lower than the damage threshold of the various equipment.

A conservative access of fire in the cabling revealed that such fire does not cause temperature rises which could affect cask integrity.

It is important that fires do not occur in the Cask Service Station, therefore three carbon dioxide fire extinguishers are provided. The assessment showed that the number of fire extinguishers is sufficient to suppress design benzine/acetone fire.

In case of all cables will start to burn in the Cask Service Station the additional extinguishers from the Reception Hall can be used (however, this assessment was rather conservative, since cables have flame retardant insulation and that they will not start to burn with an open flame).

***Storage Hall***

After welding, and other operations in the Cask Service Station the cask is transferred to its storage place in the Storage Hall using the building crane.

The Storage Hall is a huge building of about 26 m wide, 120 m long and has a height of 19 m. Its walls are made of reinforced concrete with a thickness of about 500 mm and have fire resistance R90.

## 2. FIRE SAFETY ANALYSES

The Storage Hall is separated from the Reception Hall by a shield concrete wall. There is also one shielding sliding door for moving the casks in and out.

The following fire scenarios were analysed:

- Scenario 1, Fire in the cables.
- Scenario 2, Fire in the crane.

#### Conclusions

Many conservative assumptions were made during calculations. Even in this case it was shown that the cask is exposed to 13 minutes fire duration in case of possible design fires in the Storage Hall. Due to the short fire duration and limited temperatures, the cask is not damaged.

Since the Storage Hall is equipped with a fire detection system any fires will be detected early and suppressed using available fire extinguishers, since the fire load in the storage hall is only about 10 MJ/m<sup>2</sup> (practically due to cables, which have flame retardant insulation and some other equipment) and there are no materials, which could cause rapid fire growth.

#### ***Fire in the other compartments adjacent to Reception and Storage Halls***

There are few compartments near the Reception / Storage Hall. There is a possibility that fire can occur in these compartments and can spread between them or to the Reception / Storage Hall.

Analysis revealed that:

- Walls linked to Reception and Storage Halls are made of concrete with a minimum thickness of 400 mm and fire resistance REI90.
- To avoid fire or smoke spread:
- Rooms are divided into separate fire compartments.
- Ventilation ducts are equipped with fire dampers (minimum resistance of fire dampers is EI30 and maximum – EI60).
- Important rooms or rooms with higher fire load are individual fire sub-compartments.
- A fire is detected in its early phase due to response of the detectors.
- Since there are always people (3 shifts) present during operation, the activities in manual fire suppression start immediately.
- Staff is regularly trained to fight fires.
- Methane gas system used to monitor the installation can cause an explosion hazard (if methane is accidentally released into the room).

Taking into account all mentioned features it can be excluded that fire can spread to the rooms with important systems or to the Reception or Storage Halls.

However, methane gas may cause an explosion hazard, which could result in damage to the equipment/building (but not to the cask located far from the room where methane gas is used). Therefore, methane gas sensor installed in the proximity of the ceiling for monitoring the methane concentration of the room, which shuts down methane supply.

#### ***Outside fires***

During the analysis it was shown that there are no fire hazardous facilities located nearby SNFSF-2. The nearest facility located at 50 m distance to the west from SNFSF-2 is LLW storage facility (B4).

SNFSF-2 site perimeter is fenced. There is a zone of certain width around the SNFSF-2 where there are no buildings, plants or any other equipment/facilities.

## 2. FIRE SAFETY ANALYSES

Site surfaces are mainly gravel, asphalt (for roads) and concrete pavements for personnel access. There are no combustible materials on the site.

The only possible fire hazard may be a natural forest fire. The fire will not be able to spread to the B1 facility, however smoke (depending on the wind direction) may form around SNFSF-2. Smoke itself does not affect the ISFSF, but it might be sucked via ventilation system into the premises of SNFSF-2. A fire detection system is installed in SNFSF-2, and this system is also based on smoke detectors (in B1, there are no any systems which are activated on signal “Fire” except the air supply system for the staircase from the Hot Cell service premises for safe evacuation of people). In such a case, the smoke detectors may be activated and power supply to all air supply/exhaust systems (except for staircase of the Hot Cell) and fire dampers are cut-off, so systems will stop.

Due to this, some temporary interruptions of operations may occur, however this does not influence the safety of the casks. The same situation could occur in case of a false actuation of the fire detection system.

**2.1.2.4. Periodic review and management of changes**

The review of fire safety analysis is carried out within the framework of the PSR every ten year. The Final SAR for SNFSF-2 was released in 2017 [5.36]. The PSR for SNFSF-2 shall be performed in 2027. The last Fire Safety Analysis for SNFSF-2 was performed in 2015 [5.37].

The impact of modification on fire safety SSCs important to safety is analysed in planning justifying modification.

The conducted analysis [5.38] of fire safety measures and FHA indicates that the placement of transport packaging containers with fresh nuclear fuel and packaging sets with fuel pellets in Room 039 of Building 02 does not have a negative impact on fire safety. Additionally, the concept of “defense in depth” fire protection ensures functions of prevention, detection, extinguishment, and mitigation of fire consequences, allowing the safety important components to perform their functions.

The impact of modification on fire safety SSCs important to safety is analysed in planning justifying modification.

**2.1.2.5. Regulator’s assessment and conclusions on fire safety analyses**

VATESI carried out review of the fire safety report of the interim spent nuclear fuel storage facility (SNFSF-2), substantiating the fire safety of SNFSF-2 and the review of the FHA report. This entire safety assessment and review process lasted during the construction and operation licensing of SNFSF-2 until the issuance of the permit to operate this SNFSF-2.

The following safety justification reports were submitted to VATESI for review:

Preliminary SAR „Interim Storage Facility for RBMK Spent Nuclear Fuel Assemblies from Ignalina NPP Units 1 and 2 (B1)“, preliminary FHA „Interim Storage Facility for RBMK Spent Nuclear Fuel Assemblies from Ignalina NPP Units 1 and 2 (B1)“ were approved by VATESI in 2009-08-07;

Updated SAR „Interim Storage Facility for RBMK Spent Nuclear Fuel Assemblies from Ignalina NPP Units 1 and 2 (B1)“, updated FHA „Interim Storage Facility for RBMK Spent Nuclear Fuel Assemblies from Ignalina NPP Units 1 and 2 (B1)“ were approved by VATESI in 2016-08-26;

Final SAR „Interim Storage Facility for RBMK Spent Nuclear Fuel Assemblies from Ignalina NPP Units 1 and 2 (B1)“, updated FHA „Interim Storage Facility for RBMK Spent Nuclear Fuel Assemblies from Ignalina NPP Units 1 and 2 (B1)“ were approved by VATESI in 2017-05-02.

VATESI, after reviewing the submitted SNSFS-2 safety justifications, determined that a FHA was carried out for all fire departments of SNSFS-2 buildings, including the gate house. The inventory of

## 2. FIRE SAFETY ANALYSES

combustible materials in all fire departments was calculated, and specific fire scenarios were analyzed in order to calculate the duration and impact of possible fires. It was justified that the fire resistance of the walls and doors of SNFSF-2 was sufficient to prevent unacceptable fire spread. Potential sources of ignition and firefighting preparedness were also analyzed. FHA demonstrated that a fire in the spent nuclear fuel containers storage area would last no longer than one hour, or be localized in time and ensure the invulnerability of the spent nuclear fuel container.

VATESI regularly conducts fire safety inspections at the SNSFS-2. The last inspections were carried out in 2019 and in 2022. During one of the inspections carried out by VATESI, a non-conformity with the design documentation was identified. The fire extinguisher was not found in the Gate House room, where cask with spent nuclear fuel are brought by train. The necessity of fire extinguisher is foreseen in the design documentation of SNFSF-2, and the type and amount of extinguishing material is justified in the FHA. The staff of SNSFS-2 explained that the room has sub-zero temperatures in winter (this circumstance was not assessed during the design and FHA) and therefore there is no fire extinguisher of the required type in that room. After the inspection the mandatory requirement to eliminate detected violation was issued by the Head of VATESI. The mandatory requirement was timely implemented by the employees of SE Ignalina NPP. The fire extinguisher was brought and placed in the adjacent heated room.

Taking into account the above mentioned circumstances, VATESI states that the SNFSF-2 SARs of the SE Ignalina NPP have been properly carried out and the safety of the fire protection of this facility is justified in them.

## 2.2. Waste storage facilities

### 2.2.1. Solid Waste Retrieval Facility (retrieval from buildings 157, 157/1, B2-2 project)

#### 2.2.1.1. Types and scope of the fire safety analyses

The SWRF was built in connection with the existing Ignalina NPP solid radioactive waste storage buildings inside the perimeter of the Ignalina NPP. The Retrieval Units are the installations within which the waste retrieval, pre-sorting and packaging for transfer to SWTF takes place. The Landfill Waste Separation Facility, attached to the Retrieval Unit 1, comprises equipment to pre-sort and pack the waste suitable for Landfill disposal. The Control Building is also situated close and comprises common facilities like changing room, sanitary facilities and the SWRF control room. Layout plan of SWRF is given in Figure 2.2.1-1.

## 2. FIRE SAFETY ANALYSES

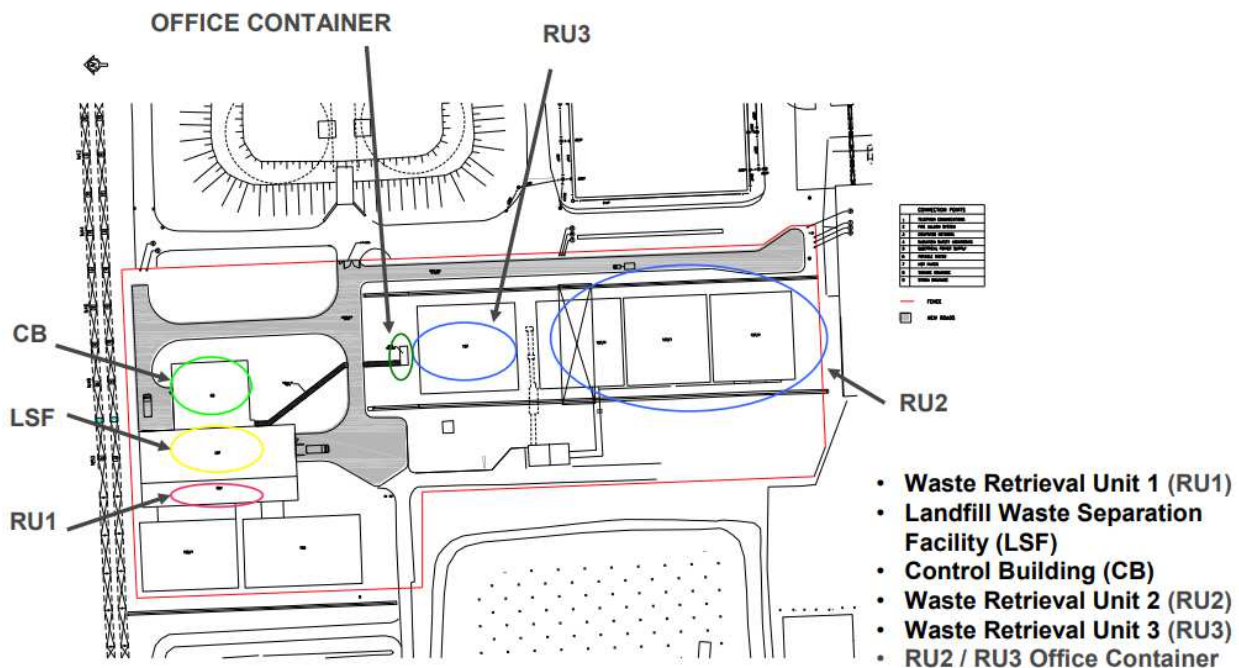

Figure 2.2.1-1. Layout of SWRF

RU2 will be used to retrieve, pre-sort and pack G1 and G2 waste from buildings 157 and 157/1. RU2 is a mobile unit located on the top of the waste storage building. The unit is able to move in 2 directions due to rails system mounted on the top of the waste storage building. Waste retrieval will be performed from the top of the waste storage compartments, after removal of closure panels. Waste will be retrieved remotely with a girder crane equipped with specific grabs, which will be lowered through on existing aperture of the roof slab of the waste compartment. Then the waste will be loaded in G1/G2 transfer containers (which during loading of waste are inside the Retrieval Unit; at one time only one type of container (i. e. G1 or G2) is in Retrieval Unit). During waste loading, the Retrieval Unit retrieves waste only from specific waste storage compartment at a time. Since G1 wastes and G2 wastes are in different compartments of the storage building therefore no special separation of wastes (into G1 or G2) during retrieval is necessary. In order to minimize retrieved waste volume and to fit large items in to the transfer containers the oversized waste will be cut using fitted tools.

RU3 will be used to retrieve the G3 waste from compartments 1 and 4 of building 157. RU3 is a fixed shed structure, located on the top of the waste storage building. Waste retrieval is performed from the top of the compartments, after removing the plugs from G3 waste compartments' roofs. Due to high G3 waste activity only appropriately shielded, automatic and remotely controlled waste retrieval and loading process are implemented. The G3 waste transfer container is equipped with a basket (situated inside the container), which can be lowered into the waste compartment by means of container mounted hoist gear through a shielded lock. The waste retrieval (i.e. waste loading into the basket of waste transfer container) is performed using inside compartment mounted (fixed in one of several existing waste loading apertures) remote tools carrier arm (manipulator). Oversized waste will be treated appropriately by means of attached tools. Once loaded, the basket with waste is lifted up into waste transfer container. Then container is closed and appropriately prepared for onward transport to the

## 2. FIRE SAFETY ANALYSES

SWTF. All waste retrieval and packaging, operations are remotely controlled from the Control Building, so the presence of operators inside the retrieval unit during these operations is not required. Layouts of RU2 and RU3 is presented in Figure 2.2.1-2.

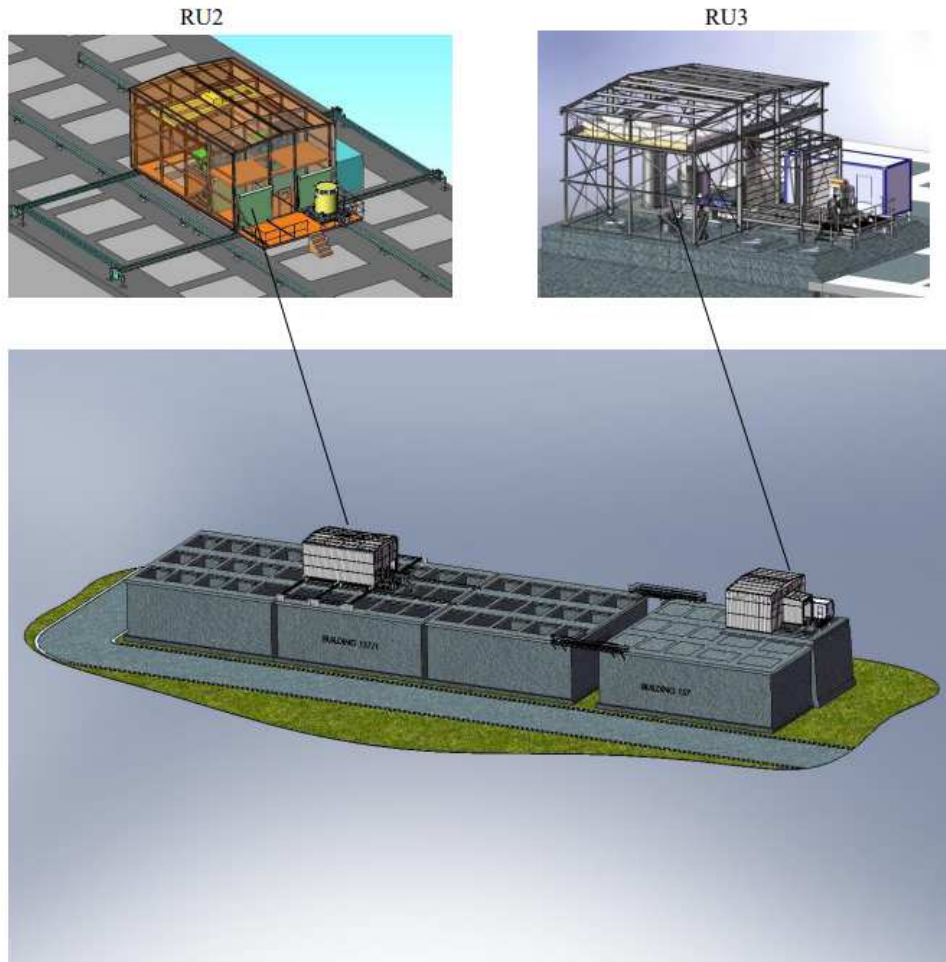

Figure 2.2.1-2. Layouts of RU2 and RU3

According to FSAR four systems were identified as important to safety including few components:

- Heating, ventilation and air conditioning system (however, only the extract ventilation system components – extract fans, fine and HEPA filters are considered as important to safety);
- Radiation monitoring system (performing functions of radiological protection of personnel and the population);
- Power supply system (since power supply to RU2/3 is coming from RU1, therefore analysis for RU1 power supply system has been done in FHA document, which is the supporting document to RU1 FSAR. See analysis there);
- Fire protection system (fire protection systems of the RU2/3 are connected to RU1 fire protection and all signals from RU2/3 are coming to RU1 fire control station).
- G1/2/3 waste containers;
- RU2 sliding hatch;
- RU3 shielded hatch.



## 2. FIRE SAFETY ANALYSES

In case of fire the personnel will not use radiation monitoring systems, operations will be stopped, and all the systems will be failed safe. After the fire, all the equipment regardless their importance to safety will be checked. Entry to the units will be allowed only with permission of radiation safety personnel and using mobile devices. In such a case the analysis is not worthwhile to be performed for the monitoring system.

Hot tests of the facility were done during 2017-2019. During hot tests there were not any issues/accidents revealed, which could cause fire hazard to the facility or its systems, structures and components.

New facilities (RU2/3) are connected to the existing waste storage buildings, and due to this fire protection (extinguishing with CO<sub>2</sub>) systems of the existing waste storage buildings was slightly modified. The modification was performed due to the reason, that pipelines were interfered with the installation of RU2/3. In the modification report [5.58] it is stated that the performed modification did not cause the changes of technical characteristics of the system and that the full fire protection of the existing buildings is ensured.

Asphalt covers roof of existing 157 and 157/1 buildings. Since asphalt is hardly ignitable, the fire hazard due to external fire is low. However asphalt was removed in the area where RU2 was set and later will also be removed step by step following operation of RU2 (for RU3 it is not relevant since all waste retrieval operations are performed inside compartment).

#### 2.2.1.2. Key assumptions and methodologies

##### Main assumptions

It is assumed that:

- Only one fire can occur at time in the facility;
- Lighting is not considered as an ignition source (since lighting with low operational temperature of lamps will be used);
- Failure of one component of the fire protection system will not lead to loss of the whole system (since fire protection system elements – fire detectors electrical circuits of the fire protection system, etc. have redundancy);
- Due to uncertainties of some data, conservative assumptions are accepted in some compartment FHA.

##### Damage thresholds

Equipment and components can be effected by fire in different ways. In the literature the temperature and heat radiation effects (thermal heat flux) are mainly discussed, because these are the only effects that can be evaluated in a quantitative way.

Damage thresholds for typical equipment are given in the Table 1-1 and for people in Table 1-2.

Table 1-1: Damage threshold for different equipment

## 2. FIRE SAFETY ANALYSES

Equipment	Critical gas temperature, °C	Critical thermal heat flux, kW/m <sup>2</sup>
Pumps	200-250	8-18
Electrical motors	200-250	8-18
Compressors	200-250	8-18
Electrical equipment	60-70	8-10
Cables	200-250	8-18

Table 1-2: Heat flux influence on people

Heat flux by thermal radiation*, kW/m <sup>2</sup>	Influence
37.5	100 % lethality after 1 min, 1 % - after 1 second
25.0	100 % lethality after 1 min and serious injuries after 10 seconds
12.5	1 % lethality after 1 min
4.0	Causes pain if exposure is more than 20 seconds; possibility of blisters occurrence is low
1.6	Constant flux does not cause any influence

\* - values for unprotected skin

The highest temperature, which a person can withstand for a long time (> 30 min.) is 60 °C, and heat flux of thermal radiation (~30 sec.) – 2.5 kW/m<sup>2</sup>.

### 2.2.1.3. Fire phenomena analyses: overview of models, data and consequences. Main results.

#### RETRIEVAL UNIT2 (RU2)

##### Background

The main structure of the RU2 is built using H and I profile metallic beams. The metallic frame of the structure is covered using Promisol type insulating panels. The insulating panel skin sheets (all outer surfaces) are made of steel sheets and inside core is filled with polyurethane or polyisocyanurate. The structure is fitted out partially with a metal sheet floor, sheet walls and top (i.e. there are no other materials on the walls, floor and ceiling which could cause fire spread).

RU2 contains ventilation, monitoring equipment and some handling equipment. The main (extract) ventilation filters are located in the retrieval room (Figure 2.2.1-3) and the fans – in ventilation room (which is located near the retrieval unit). During retrieval operations operator is always nearby RU (since some operations have to be done manually).

The shipping room is used for transfer of the containers (from the shipping platform to the docking room and reverse). Transfer is performed by trolley rolling on rails, on the unit's floor.

The shipping room is kept clean (no contamination). It is separated from the outside by roller shutter doors. The operator also realizes the statutory controls in the shipping room when the container arrives or leaves.

## 2. FIRE SAFETY ANALYSES

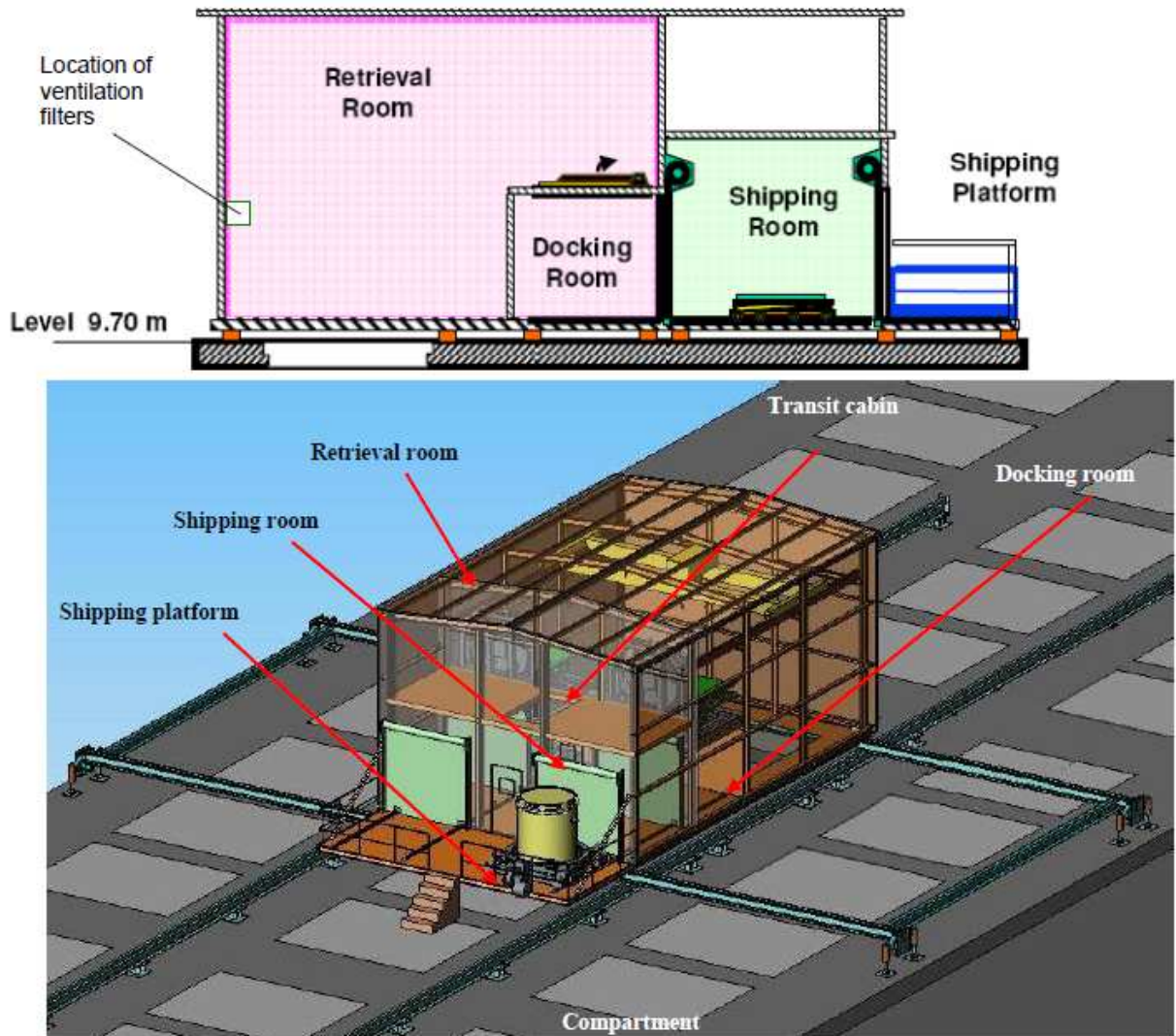

Figure 2.2.1-3. Retrieval unit 2

RU2 has low fire load (<math><600 \text{ MJ/m}^2</math>), therefore it is equipped with potable fire extinguishers only. Extinguishers are placed inside each area of the Retrieval Unit as well as in the Technical room and at the Ventilation unit. There are:

- 2 (5 kg of extinguishing media, each)  $\text{CO}_2$  fire extinguishers located in RU2;
- 1 (6 kg of extinguishing media) powder extinguisher is located in technical room.

For fire detection few smoke detectors are installed in the retrieval area and in the extract ventilation system duct (2 detectors are installed in the duct), besides there are two temperature sensors also installed in the extract ventilation system duct (Figures 2.2.1-4, 2.2.1-5).

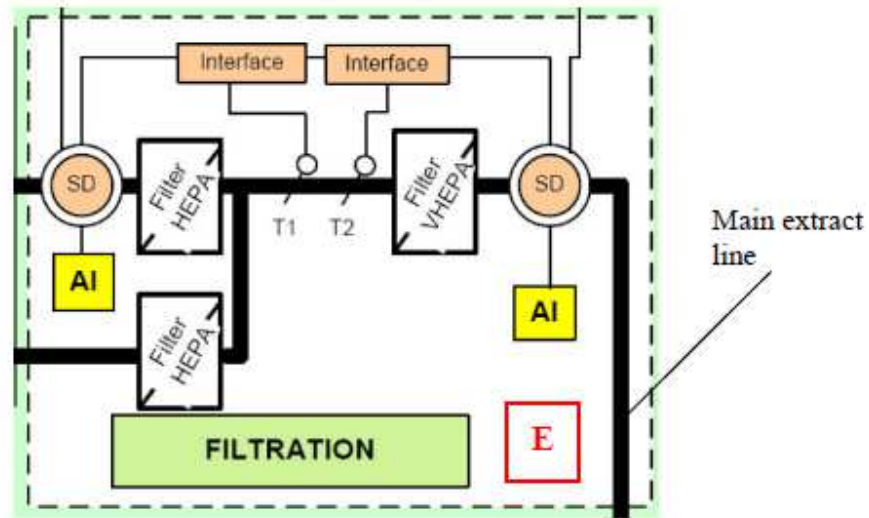

Figure 2.2.1-4. Principle of RU2 ventilation system fire protection. SD-smoke detector in dynamic pressure plug; T1/T2 – Temperature sensors; AI – Action indicator.

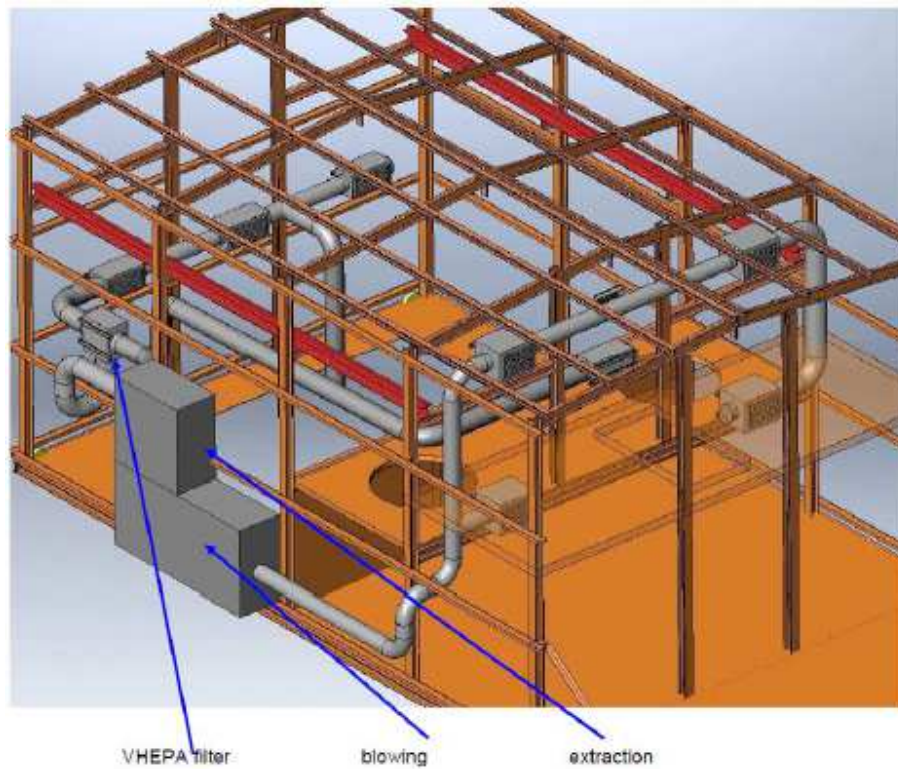

Figure 2.2.1-5. RU2 ventilation system

There is a manual push button in the shipping room for manual signalization about occurrence of the fire. Besides there are several cameras installed in the RU2 for supervision of operations (possible emergencies can also be detected by operators supervising retrieval process via cameras).

Talking in general the fire inside the retrieval unit strongly limited by the low quantity of combustible materials and inflammable products and fire spread is limited due to the structure (metallic) of the unit. What concerns fire occurrence in the G1/G2 waste storage compartments, the existing fire detection system will still be operating. In case of fire in the waste compartment, the existing system will be used to detect fire inside the compartments (additionally fire can be detected by operators visually - via cameras in RU2) the alarm of the existing fire detection system is connected to the control station at Ignalina NPP. However fire protection of the existing waste storage buildings is the Ignalina NPP responsibility.

### Fire scenario 1. Fire in the shipping room

In the shipping room there is a computer for container data registration and through the shipping room the closed waste containers are transferred into retrieval room or out of it.

Fire can occur in the computer or in the electrical motor of the transfer trolley and can damage container, ignite waste in it. As the G1 container (conservative case is taken) wall thickness with basket is 20 mm (external diameter of container is 180 cm), then, basing on the methodology for determination of fire resistance of metallic structures and assuming that container is affected by the fire from one side, the obtained parameter – specific thickness (cross section area ratio with perimeter which is affected by fire) is ~2, which, according to gives a fire resistance up to 30 minutes.

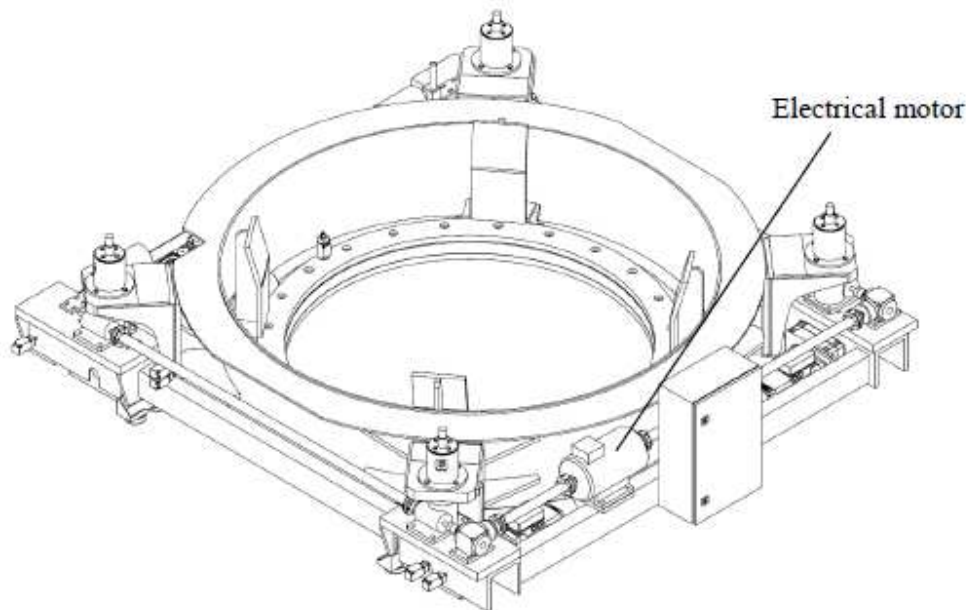

Figure 2.2.1-6. Transfer trolley

The biggest motor of the transfer trolley (Figure 2.2.1-6) has a length of approx. 0.3 m and a diameter of about 0.2 m. As it can be seen from the figure above, the motor is in a closed metallic housing. Motor is equipped with short circuit protection. The quantity of combustible material (e.g. insulation and wires) could be approx. 1–2 kg. Since motor is closed, it will not burn with an open flame in case of fire, but it may produce some smoke. Besides, when the trolley is in the shipping room, the operator is also in the shipping room (during operations). When no operations are performed, all the electrical equipment of the RU2 is de-energized, thus reducing the risk of fire occurrence. Fire in the electrical motor will not be a problem for the operator to suppress it with the available fire extinguishers. In any case, if fire

## 2. FIRE SAFETY ANALYSES

occurs in the motor, it will not be able to spread (the trolley is metallic, containers are also metallic, besides the cables used in RU have flame retardant insulation) or ignite other equipment.

Extract ventilation filters are located in the retrieval room (the retrieval room is separated from the shipping room by roller shutter doors) and any fire in the trolley (the trolley is metallic; there are no other materials, which could cause fire growth) will not be such, that flames could reach ventilation filters in the retrieval room and damage them.

Another possible fire source is computer. The exact quantity of combustible materials in a computer is not known, therefore we conservatively assume that a computer contains approximately 2 kg of combustible material, e.g. cables and electrical wiring.

It is assumed that the heat release rate in the computer is constant and never exceeds 100 kW.

Heat of combustion of electrical equipment is equal to 16400 kJ/kg and we assume that the combustion efficiency is 0.7. Fire duration, with a constant heat release rate will be:

$$t = \frac{\chi \cdot m \cdot \Delta H_c}{Q} = \frac{0.7 \cdot 2 \cdot 16400}{100} = 230 \text{ s (i.e. rather short, approx. 4 min).}$$

Computer fire will mostly produce smoke, but not open flame; the distance between the computer in the shipping room and ventilation filters in the retrieval room, is approx. 7 m.

The carbon dioxide fire extinguisher located in the shipping room (5 kg of extinguishing media) can extinguish ~700 kW fire (assuming 100% efficiency), and this shows, that using one fire extinguisher the design fire (100 kW) can be extinguished.

Taking into account the considerations mentioned above, it can be concluded that possible fires in the shipping room will not be such of a size and will not grow to such an extent that ventilation system filters or containers with waste could be damaged. The number of available fire extinguishers is sufficient to fight possible design fires.

### **Fire scenario 2. Fire in the retrieval room**

The waste retrieval is performed within the retrieval room (~9.2x8x7 m). Retrieval of waste is performed through the opening of the retrieval room. This opening (dimensions about 5.5 x 4 m) corresponds to the dimensions of the existing aperture of the waste compartment. When not in use, the opening is closed by a sliding hatch, which provides protection inside the unit.

In the retrieval room there is a remotely operated girder crane, which is used for waste retrieval and remotely controlled (hydraulic) pre-sorting machine.

The worst case could be if fire occurs in the crane (Figure 2.2.1-7). The crane contains few electrical motors and cables.

## 2. FIRE SAFETY ANALYSES

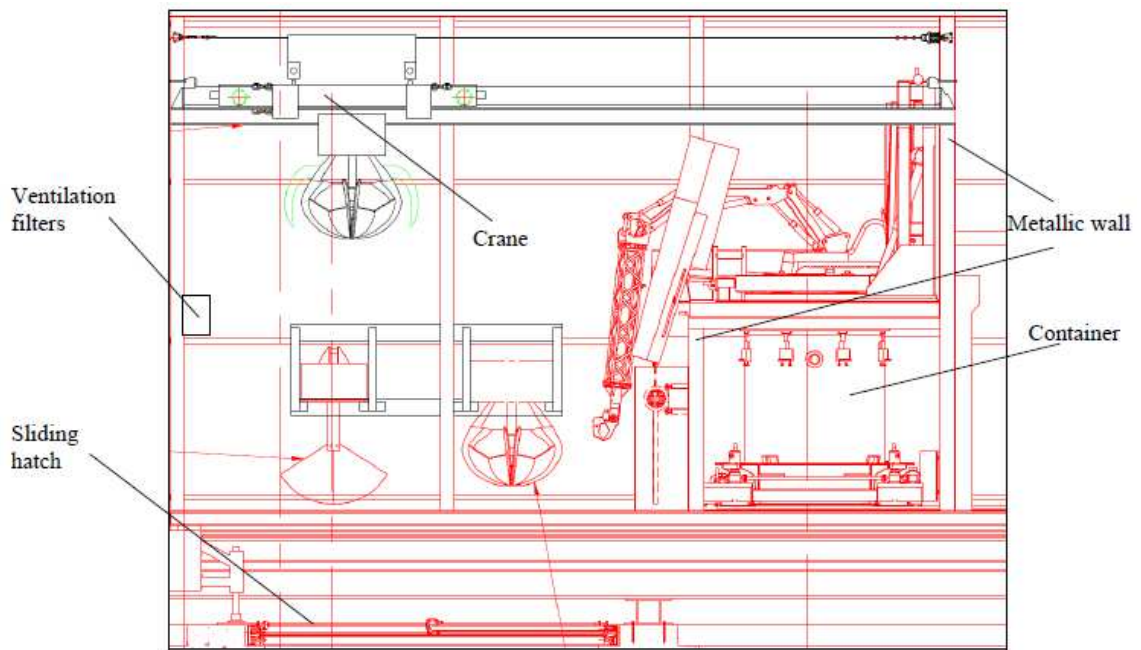

Figure 2.2.1-7. Retrieval room

However, the motors are enclosed (in housings) and in case of fire they will not burn with an open flame (according to view of the crane, the crane trolley is enclosed with metallic cover, thus additionally preventing release of flame and heat flux in case of fire) but they may produce some smoke.

Besides, the motors are equipped with overload protection and have temperature measurement sensors. The signals on the motor parameters are transferred to the control room and are continuously supervised by operators, who control the crane. All operations are also supervised by operators via video cameras and, in emergency case, power to the crane may be disconnected. Ventilation filters are located in the retrieval room at the wall as shown in Figure 2.2.1-5.

If any emergency will be noticed, the operations of waste retrieval will be stopped and sliding hatch closed. The hatch is metallic, and is equipped with position sensors. The minimum thickness of the hatch wall is 10 mm, it can assure a fire resistance for 14 minutes.

The minimum distance between the crane motors and the waste compartment hatch is approx. 4.5 m, and between the waste container and the crane (and ventilation filters) – approx. 2.2 m.

The exact quantity of combustible materials of the electrical motor is not known, therefore we conservatively assume that the motor contains approximately 6 kg of combustible material, e.g. cables and electrical wiring.

It is assumed that the heat release rate in a motor is constant and never exceeds the heat release rate of a cable tray ( $186 \text{ kW/m}^2$ ) fire of the same size as the motor housing, i.e.  $0.5 \text{ m} \times 1 \text{ m}$ . So, the heat release rate of the electrical motor, used in calculations, is 98 kW (therefore, as shown in the previous fire scenario with similar heat release, the number of fire extinguishers to extinguish a design fire of the crane is also sufficient (i.e. one 5 kg  $\text{CO}_2$  extinguisher is enough. The extinguisher is located in the retrieval room).

The flame temperature used in the calculations is  $1000 \text{ }^\circ\text{C}$ . The temperature in the room is  $20^\circ\text{C}$ .

Heat of combustion of electrical equipment is equal to  $16400 \text{ kJ/kg}$  and we assume that combustion efficiency is 0.7. Fire duration, with a constant heat release rate will be:

## 2. FIRE SAFETY ANALYSES

$$t = \frac{\chi \cdot m \cdot \Delta H_c}{Q} = \frac{0.7 \cdot 6 \cdot 16400}{98} = 702 \text{ s (or approx. 11 min).}$$

Flame height will be:

$$L = 0.235 \cdot 98^{0.4} - 1.02 \cdot 0.8 \approx 0.66 \text{ m.}$$

Heat flux to the target can be calculated from the following expression:

$$q = \Phi \cdot \sigma \cdot \varepsilon \cdot (T_1^4 - T_2^4),$$

where  $\Phi$  – configuration factor,  $\sigma$  – Boltzman's constant,  $\varepsilon$  – emissivity,  $T_1$  is the flame temperature (1000 °C),  $T_2$  is the target temperature (293 °C).

Then thermal flux in 4.5 m distance is only 0.8 kW/m<sup>2</sup>, in 2.2 m – 2.9 kW/ m<sup>2</sup>.

The thermal heat flux of 0.8 kW/ m<sup>2</sup> is rather low and does not cause any inconvenience (and will not ignite any materials) even in the case of long period of exposure, therefore any other equipment will not be damaged. Thermal heat flux of 2.9 kW/ m<sup>2</sup> is also low and will not be able to damage or ignite any equipment in the room. The minimum heat flux, which is needed to ignite wood (e.g. in our case wastes) is 12 kW/ m<sup>2</sup>.

If the crane stops near the metallic wall the thermal heat flux will be much higher and metallic sheet will be heated. However exposure time (fire time) is rather short and assuming that the volume of retrieval room is ~ 300 m<sup>3</sup> very high temperatures within the room due to design fire will not be achieved.

Temperature in the retrieval room due to design fire in the crane motor was modelled using software CFAST. Fire growth rate was assumed to be slow. Temperature variation within time is presented in Figure 2.2.1-8.

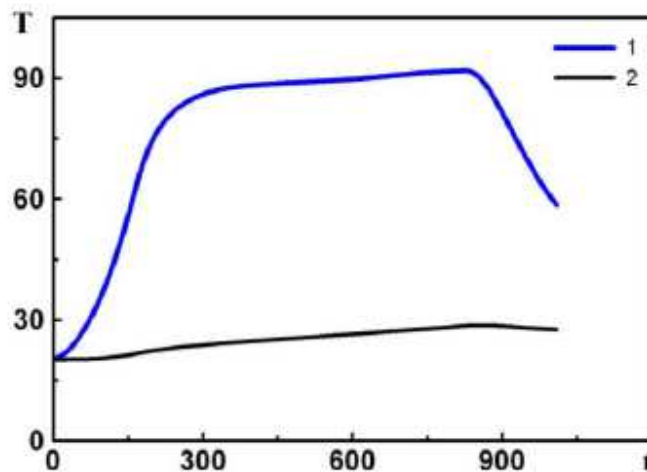

Figure 2.2.1-8. Average temperature (°C) variation vs time in the retrieval room. 1-temperature in the upper layer of the retrieval room. 2-temperature in the lower layer of the retrieval room



Since crane is located in the upper part of the retrieval room, so results of temperature modelling show that the average temperature around the crane can reach a maximum value of about 90 °C and the layer of hot gases (Figure 2.2.1-9) can be about 1.5 m thick (i.e. ~5.5 m above retrieval room floor).

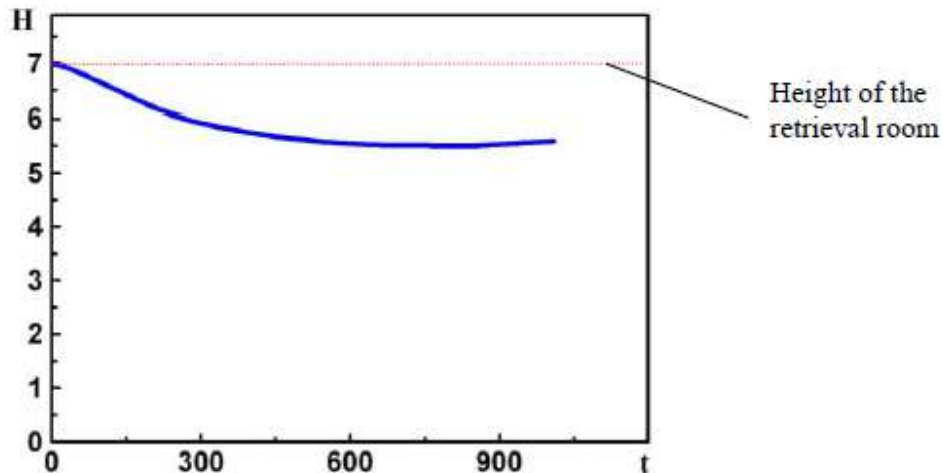

Figure 2.2.1-9. Layer of hot gases height (m) variation vs time in the retrieval room

However the average temperature in the lower layer (Figure 2.2.1-8, curve 2; i.e. till 5.5 m from the retrieval room floor) could increase to about 30°C (when fire growth was assumed to be medium, calculations with fast growth rate showed that temperature could increase more to about 8°C in both layers (now 100°C in the upper layer and ~40°C in the lower layer), however the thickness of the upper layer practically remained the same).

So it means that the equipment in the retrieval room will not be damaged in case of fire in the crane and temperatures will not be high. It should be mentioned that the calculations were rather conservative (assuming that the motor will start to burn with an open flame). In addition, it can be said, that the existing fire detection system of the G1 and G2 waste compartments of buildings 157 and 157/1 is also used to detect fire inside the waste compartment.

During retrieval operations, a fire occurrence in the retrieval room would be detected by the fire alarm system inside the retrieval room. However, if fire occurs in the RU2, all the operations will be stopped – the sliding hatch and the docking station will be remotely closed (it means that the container will be also closed), the ventilation system will be switched off and the operator will leave the retrieval unit. Fire will be extinguished by the VFRS.

A fire occurrence in the waste compartment would be detected by both – the alarm system of the RU (some detectors are also located above the hole, directed downward) and the existing fire detection system of the compartment. For both events, operators in the control building will receive a signal about fire and will inform the VFRS.

In the event of a fire in the waste compartment, the sliding hatch (and docking station) will be remotely closed to suffocate (due to lack of oxygen) the fire; propagation of a fire from retrieval room to the compartment and vice-versa cannot occur, since there are practically no combustible materials in the retrieval room that could cause rapid fire growth and long fire duration.

When no retrieval operations are performed, the waste compartment is closed by the sliding hatch thus providing fire protection of existing waste storage compartment. Since there is no waste in the retrieval room and no operations take place in the retrieval room and equipment is de-energized, there are no abilities for fire to occur in the unit. Although if fire occurs in the unit it will be detected by detectors.

In absence of operators in the RU (at night), the VFRS would therefore be informed and will act according to their procedures.

Fire occurrence in the waste compartment would be detected by the existing fire detection system.

### Fire scenario 3. Fire in the ventilation unit

Ventilation unit is set near the retrieval unit. It contains ventilation system fans and other equipment. Ventilation unit is a package unit (Figure 2.2.1-10), which contains only the equipment required for ventilation system operation.

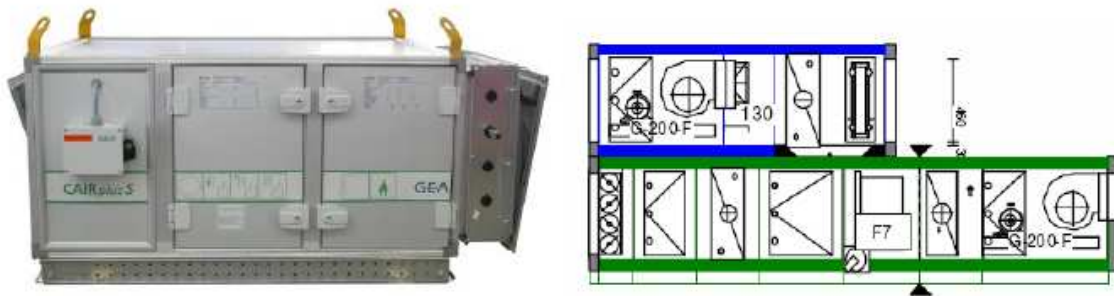

Figure 2.2.1-10. Ventilation unit

There are no other equipment in the unit. It is known that at the ventilation unit 1 powder fire extinguisher (5 kg) is installed. If fire occurs in the ventilation unit the sufficiency of extinguishing means can be roughly evaluated.

Performed calculations show that, if one fire is extinguished, a fire of electric equipment (heat of combustion 16400 kJ/kg) equal to 1400 kW can be extinguished (with 50 % efficiency of the fire extinguisher). What is the heat release rate of the unit it is not known, but in general it contains two electrical motors and some filters (Figure 2.2.1-10). For example, the heat release rate of large electrical cabinet fire is ~ 200 kW, of waste basket fire is ~ 100 kW and of plywood cupboard fire is ~ 3000 kW). Therefore, it is likely that the ventilation unit fire will not be so extensive, and it can be extinguished with the available fire extinguisher.

### Fire scenario 4. Fire in the technical room

Technical room is also located near the retrieval unit. It contains some electrical and other equipment which is not important to safety. The structure of the technical room is metallic (the technical room is like an ISO container), thus limiting fire spread.

### Conclusions

The analysis showed that possible fires in the shipping room will not be such (there is only a computer and sometimes a transfer trolley is driven in, but when the trolley is in operation, it is also in the shipping room) or will not grow to such extent that ventilation system filters or container could be damaged.

In the next fire scenario, the consequences of fire in the electrical motor of the crane (located in the retrieval room) were evaluated. Temperature modelling showed that the average temperature around the crane can reach a maximum value of about 90°C and the layer of hot gases can be about 1.5 m thick (i.e. ~5.5 m above the retrieval room floor). However, the average temperature in the lower layer (i.e. till 5.5 m from the retrieval room floor) could increase to about 30°C. The thermal fluxes of radiation in different distances (where other equipment is located) from the crane motor were evaluated. The results showed that in 4.5 m distance thermal heat flux is only 0.8 kW/m<sup>2</sup>, in 2.2 m – 2.9 kW/m<sup>2</sup>. So, it means that all the equipment in the retrieval room will not be damaged in case of fire in the crane and

fire spread from the crane via RU2 structures cannot occur due to the metallic construction of the RU2. The analyzed fire durations in RU2 will be less than the fire resistance of the sliding hatch or the waste container.

Crane fire can be suppressed with available extinguishers, however it might be complicated to reach the crane, since it is located quite high. If fire is detected in the RU, all the operations will be stopped – the sliding hatch and the docking station will be closed remotely, the ventilation system will be switched off and the operator will leave the retrieval unit. Fire will be extinguished by the VFRS, according to specific procedures (i.e. the existing Ignalina NPP procedures, adapted according to the fire protection means provided for RU2).

### RETRIEVAL UNIT 3(RU3)

#### Background

The RU3 is used to retrieve non-combustible G3 waste. The RU3 is designed as a shed (the main structure of the RU3 is built of H and I profile metallic beams. The walls and roof of the unit are formed of Promysol type insulating panels. The insulating panel skin sheets (all outer surfaces) are made of steel and the inside core is filled with polyurethane or polyisocyanurate. The floor is made from metal sheets. There are no other materials on the walls, floor and ceiling that could cause fire spread. The waste retrieval unit (Figure 2.2.1-11) is set above the waste compartment. In the other part of the unit, a shipping airlock (room) is arranged to carry out checking operations before container shipping.

In order to strongly limit the release of contamination and the level of radiation, all retrieval operations are carried out directly inside the waste compartment using a remotely controlled manipulator (tool carrier arm), which is inserted into the waste compartment through one of the holes existing in the waste storage roof.

This manipulator is fitted with an adapted tool allowing to fill the basket, which is lowered down from a container. The container is located over a shielded lock on the top of the waste storage building (i.e. on the floor of the retrieval room).

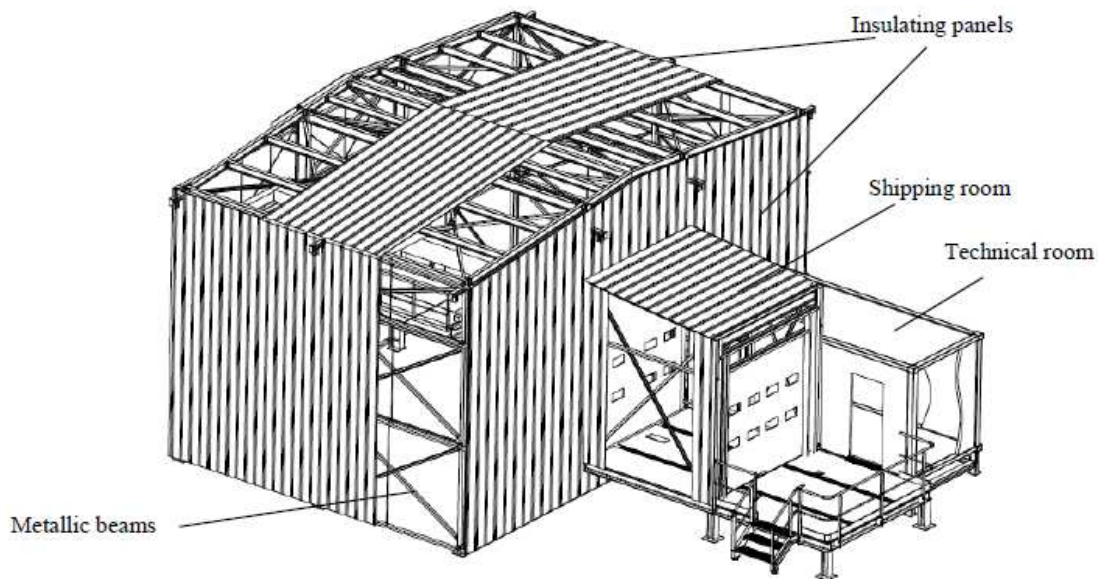

Figure 2.2.1-11. Retrieval unit 3

All operations in the RU3 rooms (as well as inside the waste storage compartment) are video supervised (by operators via cameras).

The possibility of a fire occurrence inside the retrieval room is strongly limited by the physical waste characteristics (metallic) and by the low quantity of combustible materials inside the retrieval area.

RU3 has low fire load (<600 MJ/m<sup>2</sup>), therefore it is equipped with portable extinguishers only. Extinguishers are placed inside each area of the Retrieval Unit as well as in the Technical room and at ventilation unit. There are:

- 2 (5 kg of extinguishing media, each) CO<sub>2</sub> fire extinguishers located in RU3;
- 1 (6 kg of extinguishing media) powder extinguisher is located in the technical room.

Important ventilation system filters and few monitoring devices are installed in the retrieval room. The detectors for the fire/smoke detection are installed in the retrieval room and in the extract ventilation system duct (2 detectors are installed in the duct), besides there are two temperature sensors installed in the same duct (Figure 2.2.1-12).

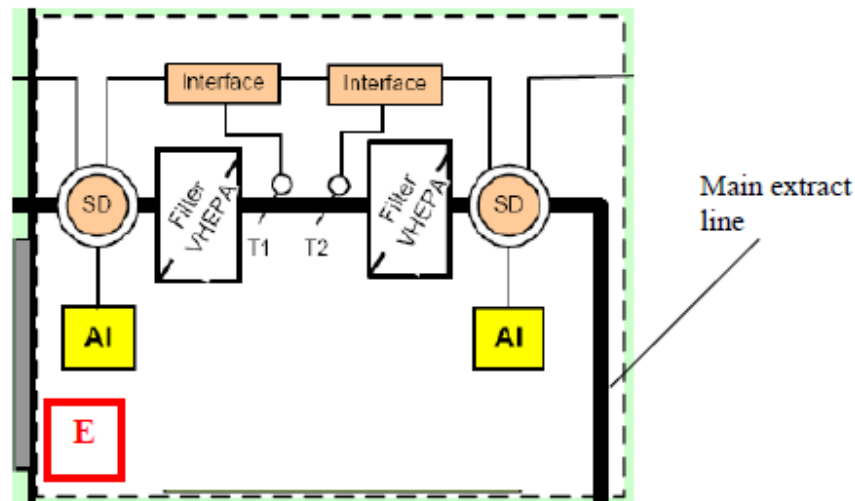

Figure 2.2.1-12. Principle of RU3 ventilation system fire protection. SD-smoke detector in dynamic pressure plug; T1/T2 – Temperature sensors; AI – Action indicator.

### Fire scenario 1. Fire in the retrieval room

Ventilation system filters, G3 container, shielded hatch are installed in the retrieval room. Ventilation system filters are located on retrieval room walls (in metallic housings).

The waste retrieval is performed inside the waste storage compartment by the remotely controlled (hydraulically driven) manipulator (tool carrier arm). Power to the manipulator is supplied by the hydraulic power unit, which is installed in the technical room (located outside RU3). Oil used for the manipulator is non-combustible, therefore fire in the manipulator can be excluded. Besides, the manipulator is covered by a metallic hood that provides radiation protection during waste retrieval and also is used to install structural modules (necessary to prolong manipulators operational area in the waste compartment). The hood is equipped with an electrical motor, which is used for hood hoist (the hoist is inside the hood, however the motor is outside; the hoist is used to install structural modules).

Total thickness of the shielded hatch is more than 400 mm, the fire resistance of such “metallic sheet” is much more than 30 minutes (does not specify the fire resistances of metallic sheets thicker than 20

## 2. FIRE SAFETY ANALYSES

mm). As the G3 container wall thickness with basket is 150 mm (the external diameter of container is 110 cm), then, basing on the methodology for determination of the fire resistance of metallic structures and assuming that container is affected by the fire from one side, the obtained parameter – specific thickness is ~26, which gives a fire resistance up to 45 minutes.

The main fire sources in the room, which can have influence on the equipment important to safety are – the electrical motors of the transfer trolley, the crane (which has few motors) and the hood (Figure 2.2.1-13).

All electrical motors of the mentioned equipment are in closed metallic housings and are equipped with short-circuit protection devices (crane motors are additionally equipped with overload protection). The cables used for these devices have flame retardant insulation (in case of fire may produce only smoke).

In case of fire, motors also may produce some smoke, but they will not start to burn with an open flame as are in the closed housings. However we assume that motors will burn with an open flame (but there are no conditions for fire to spread within RU3 – metallic structure and no additional fire hazardous materials inside RU3).

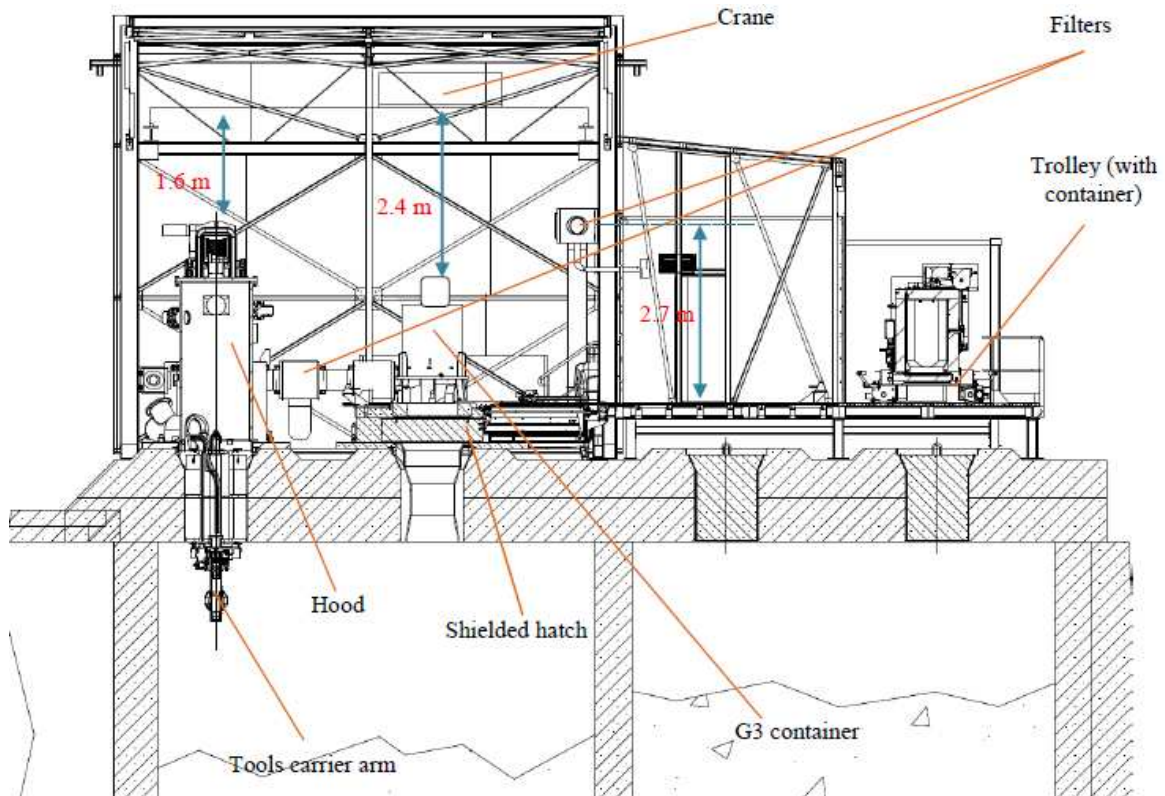

Figure 2.2.1-13. RU3 (middle cross-section shown)

The heat release rate and the thermal heat flux in case of fire from different motors in various distances are evaluated. It is assumed that the heat release rate in a motor is constant and never exceeds the heat release rate of a cable tray ( $186 \text{ kW/m}^2$ ) of the same dimensions (as the motor housing)).

In the table below (Table 3-1) a summary of calculations is presented.

2. FIRE SAFETY ANALYSES

Table 3-1: Thermal heat fluxes from different electrical motors in different distances

Motor id.	Dimensions (approx.), m	Heat release rate, kW	Flame height, m	Fire duration, min	Thermal flux exposure, kW/m <sup>2</sup>		
					in 0.45 m	in 1 m	in 2.4 m
Trolley	∅0.12 x 0.25	6	0.29	<5	1.9	0.5	-
Motor of hood	∅0.18 x 0.32	11	0.35	<5	3.2	1	-
Crane motor (only one motor is taken)	∅0.5 x 1	93	0.66	<12	14.8	8.5*	2.45

In 1.6 m (i.e. it is the distance between the crane and the hood motor and between the crane and the filters installed near the shipping room; see Figure 2.2.1-13) thermal flux exposure was determined to be 4.7 kW/m<sup>2</sup>. The other ventilation system filters are placed near the retrieval room floor (Figure 2.2.1-13) at the eastern wall, however there any no ignition sources in the distance of about 2 m around these filters.

The distance between the trolley motors (Figure 2.2.1-14) is approx. 45 cm. If it somehow happens that one motor will start to burn with an open flame, then the other motor will be exposed to a thermal heat flux of approx. 1.9 kW/m<sup>2</sup> and will not be damaged since the damage threshold is ~ 8 kW/m<sup>2</sup>. Besides, the motor contains low quantity of combustible materials (~ 1 kg), therefore the fire time (exposure time) will be short and the container/hatch will not be damaged.

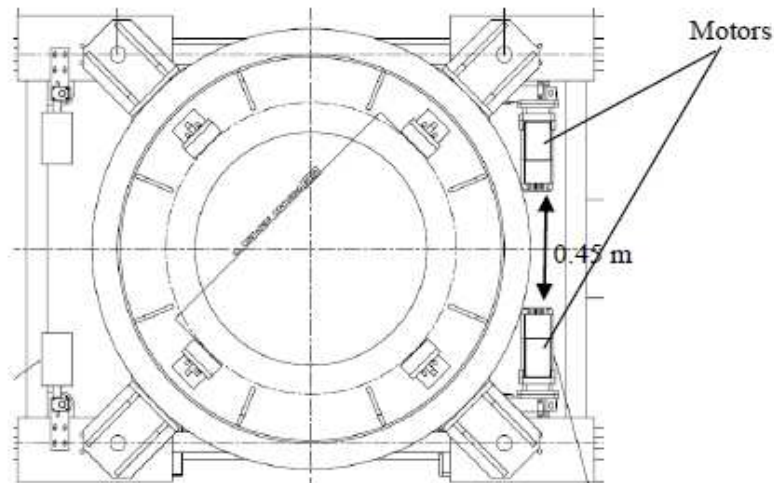

Figure 2.2.1-14. Trolley (top view; for information only).

Fire in the motor of the hood also shows that during the event in short distance (0.45 m), the heat flux is rather low – 3.2 kW/m<sup>2</sup> and this means that no redundant (electrical) equipment during retrieval operations, the container remains attached to the crane. The distance between the crane and the container is approx. 2.4 m. It was assumed that one of the crane motors starts to burn (the motor was assumed to contain the same amount of combustible material as it was the RU2 crane) with an open flame (the crane is mostly used only to take the container from the trolley and to put it on the shielded hatch, and when the container is loaded with waste, the crane takes the container from the hatch and puts back on the trolley; during stop phases, the crane is de-energized, thus reducing the risk of fire occurrence). Calculations show that heat flux to the nearest equipment (container) will be 2.45 kW/m<sup>2</sup> and the heat

## 2. FIRE SAFETY ANALYSES

flux to the nearest filters will be  $4.7 \text{ kW/m}^2$  (this is a conservative value, based on the assumption that the crane stands directly above the mentioned equipment) and therefore filters, or container will not be damaged and fire exposure time will be less than 12 minutes.

The highest temperatures in the retrieval room could be achieved due to the RU3 crane fire since it has the biggest electrical motors in comparison with other equipment located in the room. Temperature in the retrieval room due to design fire in the crane motor was modelled using software CFAST. Fire growth rate was assumed to be slow. Temperature variation within time is presented in Figure 2.2.1-15.

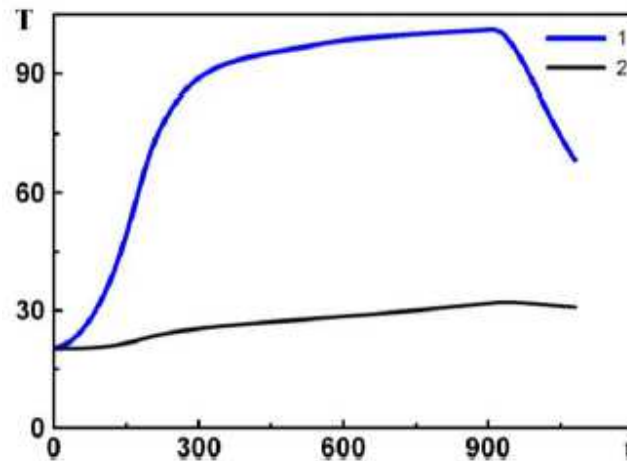

Figure 2.2.1-15. Average temperature ( $^{\circ}\text{C}$ ) variation vs time in the retrieval room. 1-temperature in the upper layer of the retrieval room. 2-temperature in the lower layer of the retrieval room

Since crane is located in the upper part of the retrieval room, the temperature modelling results show that average temperature around the crane can reach a maximum value of about  $100^{\circ}\text{C}$  and the layer of hot gases (Figure 2.2.1-16) can be about 2 m thick (i.e.  $\sim 5$  m above the retrieval room floor).

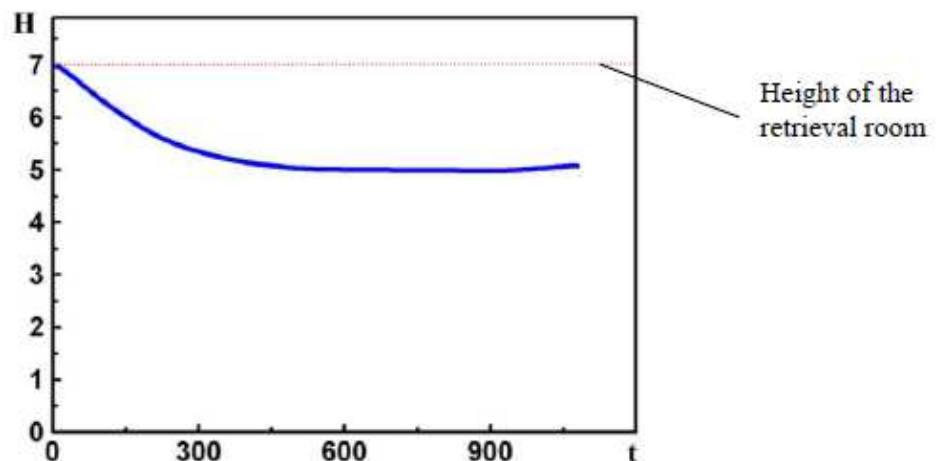

Figure 2.2.1-16. Layer of hot gases height (m) variation vs time in the retrieval room

However the average temperature in the lower layer could increase to about  $33^{\circ}\text{C}$ .

So significant temperature increase could be only in the space where the crane is located. But in any case it is much lower than the critical temperature for the steel structures ( $460^{\circ}\text{C}$ ), therefore steel structures of the unit, the crane itself and equipment located in retrieval room could be damaged. Besides

the crane fire exposure (duration) with a constant heat release rate to the other components will be rather short – about 11 minutes.

There are no other materials in the retrieval unit which could cause fire growth, therefore a number of available fire extinguishers is enough to fight possible fires in RU (since with one CO<sub>2</sub> extinguisher a fire of more than 400 kW of electrical equipment can be suppressed (assuming 50% efficiency), assuming heat of combustion 16400 kJ/kg; calculations showed that the largest design fire in the RU3 can be of ~ 100 kW).

If a fire is detected within the RU3, the operator is automatically informed about (potential smoke will also be detected by operators in the control building via the cameras, since processes during retrieval are continuously supervised) that, and retrieval will be stopped – the equipment in the unit will be set in safety position (basket, shielded hatch and manipulator) and the VFRS will be informed (due to the low fire load, fires in RU3 can only be negligible); the ventilation system will be kept in operation so that to maintain the dynamic containment, up to a maximal permissible temperature for filters. Then filters will be isolated (by closing the grilles of the filter housings), the ventilation system stopped (filters in safety position), and the appropriate measures such as fire extinguishing with extinguishers will be applied by the fire brigade to suppress the fire.

When no retrieval operations are being performed (e.g. at night), the waste compartment is closed by the shielded hatch and the equipment is de-energized, there are no possibility for fire to occur in the unit. Although, if fire occurs in the unit, it will be detected by the fire detection system. The fire brigade of the VFRS will be informed.

### Fire scenario 3. Fire in the ventilation unit

The RU3 ventilation unit is also a package unit. It contains ventilation system fans and other equipment. Ventilation unit (Figure 2.2.1-17) contains only the equipment required for the ventilation system operation. The fire in this unit is not analyzed as it is standard equipment manufactured according the relevant regulations and design rules.

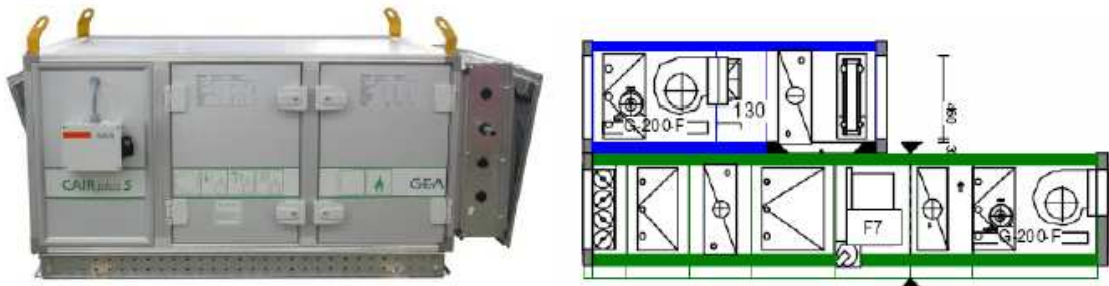

Figure 2.2.1-17. Ventilation unit

However, it is possible to evaluate the sufficiency of the fire extinguishing means. It is known that 1 powder extinguisher (5 kg) shall be in the technical room (which is close to the ventilation unit).

Performed calculations show that using one powder fire extinguisher (5 kg of extinguishing media) a fire of electrical equipment (heat of combustion 16400 kJ/kg) of 1400 kW (assuming 50% efficiency of the extinguisher) can be extinguished. The heat release rate of the unit it is not known, but in general it contains two electrical motors and some filters. For example, the fire of a large electrical cabinet is about 200 kW, wastepaper basket ~100 kW, plywood wardrobe – ~ 3000 kW.

Therefore it is likely that a fire in the ventilation unit will not be so large, and it can be extinguished with the available fire extinguisher.



**Fire scenario 4. Fire in the technical room**

The technical room is located near the RU3. It contains UPS and other equipment which is not important to safety. The structure of the technical room is metallic (the technical room is like an ISO container), thus limiting fire spread.

**Conclusions**

Only the extract ventilation system filters (located in metallic housings), the G3 container and the shielded hatch are the main equipment important to safety, located in RU3. A few fire scenarios were analyzed.

RU3 contains few electrically driven devices (trolley, hood hoist and crane). The electrical motors of the trolley and the hood hoist are rather small and the conservatively determined thermal fluxes of radiation in case of fire in these motors are rather low even at 0.45 m distances ( $3.2 \text{ kW/m}^2$ ) and the fire duration is short.

In the next fire scenario, the consequences of the fire in the electrical motor of the crane (which is located in the retrieval room) were evaluated. The conservative temperature modelling showed that the average temperature around the crane can reach a maximum value of about  $100^\circ\text{C}$  and the layer of hot gases will be about 2 m thick (i.e.  $\sim 5$  m above the retrieval room floor). However, the average temperature in the lower layer (i.e. till 4–5 m from the retrieval room floor) could increase to about  $33^\circ\text{C}$ . But in any case, it is much lower than the critical temperature for steel structures ( $460^\circ\text{C}$ ), therefore the steel structures of the unit, the crane itself and the equipment located in the retrieval room (container, shielded hatch) will not be damaged. Besides, the crane fire exposure (duration) with a constant heat release rate to the other components will be rather short – about 11 minutes.

The thermal fluxes of radiation in the distance of the nearest equipment from the crane motor were also evaluated. The results showed that in 1.6 m distance (where the nearest vulnerable equipment – ventilation filters are installed) the thermal heat flux is  $4.7 \text{ kW/m}^2$  in 2.4 m (e.g. where the container is located), it is  $2.45 \text{ kW/m}^2$  (such flux has no influence). So, it means that all the equipment in the retrieval room will not be damaged in case of fire in the crane and fire spread from the crane via RU3 structures cannot occur due to metallic construction of the RU3 and absence of other fire hazardous materials.

Crane fire can be suppressed with available extinguishers; however, it might be complicated to reach the crane, since it is located quite high.

Since the ventilation unit of the RU3 is a package unit, only the sufficiency of the fire extinguishing means was evaluated. The evaluation showed that the powder extinguisher, which is foreseen for such needs, is sufficient to extinguish a design fire.

**FIRE DURING TRANSPORTATION OF COMBUSTIBLE WASTE FROM BUILDINGS 157 AND 157/1**

The analysis of the fire hazard during waste transportation is made mostly qualitatively.

G1 and G2 wastes (combustible and non-combustible) are transferred in respective G1 or G2 containers. G3 waste is transferred only in G3 containers (G3 waste is non-combustible waste).

All the containers are made of steel (thus, non-combustible). The wall thickness of the G1 container is 1 cm, the G2 container has a wall thickness of 4 cm and the G3 container has a wall thickness of 15 cm (the bottom (drawer) thickness is about 7.5 cm). A metallic basket is inserted into the containers. The basket serves as a “package” for the waste. The basket used in G1 or in G2 container is the same. The

## 2. FIRE SAFETY ANALYSES

basket is also made of steel (i.e. non-combustible) with a wall thickness of 1 cm. The basket of the G3 container also has a wall thickness of 1 cm. So, the waste is loaded into the basket, and the basket is inserted into the container. After that, the container (G1/2) lid (steel) is closed and locked (the correctness of the locks is checked before the waste is dispatched from the retrieval unit). Lids of both containers (G1/2) are also made of steel with respective thickness (1 or 4 cm). "Lid" (drawer) of the G3 container is also made of steel.

Taking into account the above-mentioned information, it can be concluded that the waste is quite well isolated from the outside.

The transportation of the waste containers to Solid Waste Management and Storage Facilities (B3/4 project) is performed by a tractor (this is a diesel powered tractor) with a trailer. The overall dimensions of the tractor are ~4.71x2.2x3.0 m. During the waste transfer, the distance between the tractor and the container on the trailer is at least about 1.5 m. Even if due to some reasons a fire starts in the tractor, its spread to the trailer will not occur due to the metallic construction of the tractor/trailer and the trailer linkage. Besides, during transfer operations, the tractor is controlled by the operator (driver), so any emergency situations will be immediately noticed, and appropriate actions taken (e.g. disengagement of the trailer from the tractor, calling for help or another tractor (two tractors are foreseen in the project) to take away the trailer, initial fire extinguishing with manual firefighting means). The call for help also can be made immediately, since it is foreseen, that the drivers will use walkie-talkies during the waste transfer operations. Even if a fire starts in the tractor and the trailer will be still hung to it, the waste inside the container will not be affected due to the following reasons:

- That each trailer has a shielding protection (a plate of minimum dimensions of ~1600x1600x50 mm) on the front of the trailer, so that the heat of radiation/temperature affecting the container will be "reduced" by the metallic shielding of the trailer.
- Separation distance between tractor and container.
- The G1/G2 containers fire resistance is up to 12 minutes (taking into account the minimum thickness of 1 cm).
- The G3 containers fire resistance is up to 30 minutes (taking into account the minimum thickness of 7.5 cm).
- Tractor is equipped with a manual fire extinguisher, which will be used by the driver in case of fire for its suppression and/or initial control.

In any case, ignition of container itself is not possible due to its properties (steel).

Roughly, the duration of the diesel fuel fire is evaluated below. The heat release rate from such a fire can be calculated using formula:

$$Q = m \cdot \Delta h_c \cdot A \cdot \chi,$$

$m$  – fuel evaporation rate from surface ( $\text{kg}/\text{m}^2 \cdot \text{s}$ ),  $\Delta h_c$  – fuel heat of combustion ( $\text{MJ}/\text{kg}$ ),  $A$  – fire area ( $\text{m}^2$ ),  $\chi$  – combustion efficiency (usually 0.7-0.8).

For diesel fuel  $m=0.045 \text{ kg}/\text{m}^2 \cdot \text{s}$  and  $h_c=44.4 \text{ MJ}/\text{kg}$  therefore:

$Q=0.045 \cdot 44.4 \cdot (4.72 \pi/4) \cdot 0.75=26 \text{ MW}$  (4.7 m is the length of the tractor and it is assumed to be as a diameter of leaked fuel area).

Theoretical fire duration  $t$  of the leaked and ignited fuel at the constant heat release rate can be calculated using formula:

$$t = m_{\text{fuel}} / m \Sigma,$$

$m_{\text{fuel}}$  – all the mass of diesel fuel (kg),  $m \Sigma$  – total fuel evaporation velocity from the fire surface ( $\text{kg}/\text{s}$ ).

## 2. FIRE SAFETY ANALYSES

$t = 0.250 \cdot 840 / (0.045 \cdot (4.72 \cdot \pi / 4)) = 270 \text{ s}$  ( $0.250 \text{ m}^3$  is the volume of the tractor's tank and diesel fuel density is  $\sim 840 \text{ kg/m}^3$ ).

Thus, the calculations show that the fire duration can be about 5 minutes. Fuel leakage to the larger area will result in higher heat release rate, but shorter fire duration. In the opposite case – fuel leakage to the smaller area, e.g. twice smaller, will result in a fire duration of about 520 seconds or  $\sim 9$  minutes, but in such a case the heat release rate will also be lower. Thus, to reduce the fire exposure to the container with the waste, one of the measures could be to limit the filling of the diesel fuel tank of the tractor to half.

The route for the transportation of the waste to B3/4 facility or to the RU1 facility does not involve any hazardous facilities in the vicinity that could affect the waste transfer or cause a fire hazard.

Fire during lowering of the container with the waste from the roof of the existing building to the trailer on the ground is not analyzed due to the following reasons:

- During the lowering process, the container is in the air (it is hanging on existing crane ropes).
- Since container is in the air, it is far away from possible ignition sources.
- In any case, the container is hardly ignitable due to its properties (steel);
- The fire resistance of G1/G2 containers is up to 12 minutes (taking into account the minimum thickness of 1 cm).
- The fire resistance of G3 containers is up to 30 minutes (taking into account the minimum thickness of 7.5 cm).

### Recommendations and safety improvement measures

After performing FHA for RU2/3 recommendations were proposed, for instance, to prepare Accident liquidation plan for the units (including existing waste storage buildings or separate) and to organize functional training between Ignalina NPP and VFRS staff; In the case of fire in the retrieval unit, fire extinguishing manager of VFRS shall account the time of the firemen in the radioactive environment and timely perform their rotation; Ensure decontamination of personnel extinguishing fire and decontamination their fire extinguishing equipment. All appropriate safety improvement measures were implemented.

### Periodic review and management of changes

The review of fire safety analysis is carried out within the framework of the PSR every ten year. The Final SAR for SWRF (RU2, RU3) was released in 2020 [5.39]. The PSR for SWRF (RU2, RU3) shall be performed in 2030.

The last Fire Safety Analysis for SWRF (RU2, RU3) was performed in 2020 [5.40].

The impact of modification on fire safety SSCs important to safety is analysed in planning justifying modification.

#### 2.2.1.4. Regulator's assessment and conclusions on fire safety analyses

VATESI after review approved the technical project, SAR and FHA report for Solid waste retrieval facility (retrieval from buildings 157, 157/1 (B2-2 project)) and the modification of the installation of equipment for removing radioactive waste from storage facilities in 2014. In June 2020, VATESI approved updated safety justification documents (final SAR and final FHA of Solid waste retrieval facility (retrieval from buildings 157, 157/1 (B2-2 project)) installed on the Ignalina NPP solid radioactive waste storage facilities (buildings 157, 157/1) based on the results of hot trials. This decision of VATESI allowed the start of commercial operation of the facilities. The safety justification documents submitted for VATESI review indicate, that the fire detection and extinguishing system in

## 2. FIRE SAFETY ANALYSES

the waste storage sections G1 and G2 of buildings 157 and 157/1 will be able to detect a fire in these sections and the fire alarm system of the fire detection system will immediately inform the staff 24 hours a day on duty at Ignalina NPP. VATESI agreed with the conclusion presented in the report that in the event of a fire in the waste storage facilities sections G1 and G2 of buildings 157 and 157/1, the old fire extinguishing system of the waste storage facilities are suitable for further use, meets the requirements of the current legislation and its functionality and sufficiency at the Ignalina NPP was properly justified. In reports it was properly justified that the newly installed fire protection system would ensure fire safety. Systematic FHA for RU-2, including the fire in the shipping room, fire in the retrieval room, fire in the ventilation unit, fire in the technical room were performed. Systematic FHA for RU-3, including fire in the retrieval room, fire in the ventilation unit and fire in the technical room has been analyzed. Also a FHA has been carried out during transportation of combustible waste from 157 and 157/1 buildings. Based on the combustible inventory in the Solid waste retrieval facility (retrieval from buildings 157, 157/1) specific fire scenarios were analyzed to calculate the duration and influence of potential fires. After review the reports, VATESI determined that the fire resistance of the building walls, RU-2 and RU-3 equipment is sufficient to prevent fire spread. All potential sources of ignition and the suitability and adequacy of fire extinguishing agents have been assessed properly in the FHA and this has been approved by VATESI.

During the VATESI fire safety inspections at Solid waste retrieval facility (retrieval from buildings 157, 157/1 (B2-2 project)) in 2019 and in 2021, were confirmed, that fire extinguishing plans of Solid waste retrieval facility (retrieval from buildings 157, 157/1 (B2-2 project)) are prepared. Also were checked how the technical maintenance of fire hydrants is ensured. Also were checked the technical condition of the fire extinguishing gas system, fire detection and alarm systems and it was ensured that these systems meet the design requirements.

VATESI review of the Solid waste retrieval facility (retrieval from buildings 157, 157/1) justification documents found, that the following fire safety analyses submitted by SE Ignalina NPP were carried out in accordance with the requirements of VATESI, and all of them were accepted by VATESI.

### **2.2.2. Solid Waste Treatment and Storage Facilities (B3/4 project)**

#### **2.2.2.1. Types and scope of the fire safety analyses**

The Solid Waste Treatment and Storage Facility was built on a new site at about 0.6 km to the south from the Ignalina NPP perimeter. A radioactive Waste Transfer System is established between the Ignalina NPP and SWTSF sites for transfer of retrieved waste from SWRF and for waste produced by decommissioning of Ignalina NPP.

The Solid Waste Treatment Facility (SWTF) houses equipment and facilities necessary for the treatment of the solid radioactive waste. The design of the SWTF is based on different sorting cells and subsequent waste processing facilities. In the sorting cells the waste is processed in parallel streams according to its respective radiological characteristics. Then sorting, size reduction and other preparations take place prior to incineration, high force compaction and/or grouting.

After sorting, the waste is re-categorized from Class B to Class F according to its ultimate destination:

- Class B and C waste: low and intermediate-level for short-lived (SL) intermediate storage;
- Class D waste: low-level waste and graphite for long-lived (LL) intermediate storage;
- Class E waste: intermediate-level waste for LL intermediate storage;
- Class F waste: spent sealed sources for LL intermediate storage.

## 2. FIRE SAFETY ANALYSES

The Solid Waste Storage Facility (SWSF) comprises two stores, which are directly connected to the SWTF: one store for SL and the other for LL waste.

Five systems were identified as important to safety:

- Ventilation system;
- Radiological monitoring system;
- Handling system;
- Power supply system;
- Fire protection system.

Division of facility to fire compartments and sub-compartments, availability of fire detection, extinguishing means is presented in design documentation and is not repeated here.

Design and layout of the SWTSF was determined taking into account hazards of the technological process which may have an adverse effect of the personnel/public health and risks resulting from the fire both for the personnel and for the VFRS participating in extinguishing the fire.

The SWTSF is a reinforced concrete building equipped with all necessary social facilities, Access Areas to Controlled Areas, physical protection and safety alarming installations, equipment for waste treatment and areas for waste storage. The SWTSF is supplied with all the necessary media (electricity, potable, process water and other process media). In order to limit fire spread and to provide fire resistance SWTSF is divided into fire compartments and sub-compartments.

The fire load in the different premises in the SWTSF is the following:

- Staircases, accesses: ~40-90 MJ/m<sup>2</sup> (mostly due to cabling and electrical equipment);
- Personnel locks: ~170-201 (and in some up to 590) MJ/m<sup>2</sup> (due to cabling and monitoring equipment);
- Process areas: ~80-430 (in some up to 6400) MJ/m<sup>2</sup> (due to process equipment and cabling);
- Electrical rooms: ~470-1570 MJ/ m<sup>2</sup> (due to electrical equipment);
- SLW, LLW waste storages: ~7.5 MJ/ m<sup>2</sup>.

The most part of fire load in different premises (accesses, staircases, personnel locks, shafts, etc.) is due to cabling. All the cabling equipment used in SWTSF has fire retardant coating. All the premises of the SWTSF are equipped with fire detectors for fast fire detection (for the sake of reliability at least 2 detectors are used in one compartment), besides there are manual fire-fighting means – manual fire extinguishers located near the entrances to the compartments. SWTSF is also equipped with internal cocks and external fire hydrants for water fire-fighting (water flow rate for internal fire fighting is 10 l/s, for external – 30 l/s. The extinguishing system design, was defined taking into account the fire load category of each room, the continuous presence of personnel, and the identification of the combustible/flammable and potentially radioactive materials inside each room).

Personnel working in SWTSF understands all the hazards and are well trained for fire-fighting, besides VFRS is located near SWTSF (approx. 6 km; it takes about 15-20 minutes to reach the facility). Signals about fires in SWTSF to VFRB are transmitted by calling Emergency response center by phone number 112 (SWTSF accident liquidation plan is prepared). Arrival time of Visaginas Fire and Rescue Service to the facility is about 15-20 minutes.

#### 2.2.2.2. Key assumptions and methodologies

##### *Introduction*

The objective is to present a model gallery description to be used as introduction and direction guidance in the detailed further analysis of rooms at the SWTSF.

***Rate of heat release***

The fire effect  $Q$  can be calculated with the following formula:

$$Q = m \cdot \Delta h_c \cdot A \cdot \chi,$$

where  $m$  - the fuel that evaporates from the surface ( $\text{kg}/\text{m}^2 \text{ sec}$ ),  $\Delta h_c$  - the energy content in the fuel ( $\text{MJ}/\text{m}^3$ ),  $A$  - the burning area ( $\text{m}^2$ ),  $\chi$  - the combustion efficiency (for oils normally 60-70%).

**Gas temperature**

The temperature in the gas layer generated by the fire was considered. How this was done depends on the fire scenario's relation to the room configuration but some kind of computer model is often needed. When evaluating the gas temperature a recommended first step is to use a computer zone model to model the fire. This gives sometimes enough information to decide if critical conditions can occur but not always. If great turbulence is expected in the room or if the fire is very small compared to the room volume the result from the zone modelling have to be verified using other methods, like CFD-modelling or complementing hand calculations.

The input that is required for a zone model is the design fire curve, the room configuration, the ventilation conditions and the ambient conditions in the room. The output given from the model is, for example, the gas temperature in the upper and lower layers, the gas layer height and the rate of heat release. A way to decide if the zone model is valid for the specific scenario is to compare the gas temperatures in the upper and lower layers. If these temperatures do not differ by more than  $10^\circ\text{C}$ , then the zone model cannot be used to evaluate the gas temperature and layer height because the difference in density will then be too small to create separate layers.

**Computer models**

Zone models are often used to calculate the gas temperature and the height of the gas layer as a function of time.

Zone models describe the influence of fire in an enclosed room by using a limited number of zones or control volumes. The most common model is the so-called two-zone model, which divides the room into two distinct control volumes; one upper control volume near the ceiling called as upper layer, consisting of burnt and entrained hot gases and one cold lower layer which contains fresh air.

Semi-empirical equations for mass, momentum, energy and chemical species are solved separately for the upper and lower layers respectively and the transition of mass and energy between the zones is accounted for by the use of a plume model. In some models, the plume appears as a third "layer". In other models the influence of the plume is ignored. The transient plume effects, like the temporal build up of the plume and the time for the hot gases to move from the core of the fire in the lower layer to the upper layer, are then left without consideration. The two layers, or control volumes, are assumed homogenous and temperature, density, pressure et cetera can be considered to represent average values over the zones.

The approximations made in zone models are well documented and information on this is readily available. A large number of experiments have been performed in order to verify and evaluate the validity of zone models and to identify the uncertainties. It is a matter of course that there are uncertainties embodied in these models and that in some cases the errors are of a magnitude that clearly makes the zone model inapplicable.

In large and/or complex areas the CFD models are therefore recommended. The zone model should not be used if it generates a temperature difference between the two layers of less than  $10^\circ\text{C}$ , because no zones can be expected to exist under these conditions.

If the zone model is decided not to be enough to evaluate the consequences a CFD-model can be used. This is a very complex computer models where the room is divided into small control volumes. CFD model is appropriate to use when the:

1. Room is large.
2. Temperature differences between the gas layers are small.
3. Turbulence in the room is great.

The accuracy of a simulation depends for example on factors such as the grid resolution and the specific models being used. Field modelling is a powerful tool given that the engineer is well aware of the limitations and uncertainties in the used software. Because of the large and hard work effort coming with the CFD modelling this is recommended only in complex and/or large areas where the zone model is not appropriate to be used.

### **Plume temperature**

When the redundant paths are located in the absolute vicinity of the fire a plume model was used to verify if the plume can affect the paths.

The plume temperature can be calculated using hand calculations or computer programs such as zone models or CFD models. Using hand calculations different plume model depending on the size of the fire is used. The output from the plume models is the temperature in the plume at different heights and the width and height of the plume. If the plume is shown to involve the redundant paths the plume temperature was compared with the damage thresholds.

There are different plume models available to use. The different models are suited for different situation. The Heskestad plume model will be presented in more detail (this model was used when performing FHA for the Ignalina NPP Units 1 and 2; since SWTSF contains very similar equipment (e.g. cables, electrical motors and cabinets), this model was also used for SWTSF).

Heskestad presents in his plume model also an equation to calculate the plume centerline temperature. Note the plume temperature is higher than the temperature in the surrounding gases. The following chart shows how the plume temperature decreases with the height of the plume. The higher up in the plume the more air is entrained, which lower the plume temperature remarkably. The equation below is used to calculate the plume centerline temperature.

$$\Delta T_0 = 25 \left( \frac{Q^{2/3}}{(z - z_0)} \right)^{5/3} \text{ (}^\circ\text{C)}$$

### **Heat of radiation**

Heat of radiation can be caused by the flame but also by a hot gas layer. A hot gas layer can radiate both to a component placed at floor level but also at a component placed in the gas layer itself.

The heat of radiation from the flame to the safety paths shall always be calculated unless this obviously is not a threat.

The radiation from a flame can be calculated treating the flame as a rectangle and using configuration factors. The worst case of heat of radiation from a flame is calculated assuming a flame height corresponding to the maximum heat release rate though less than the height of the room.

The input to the calculations is basically flame height, flame width and distance from flame to object. The output is the heat of radiation to a point in kW/m<sup>2</sup>.

The heat of radiation from a flame to a target can be calculated using hand calculations, treating the flame as a rectangle, and using configuration factors. Models for calculating heat of radiation can also be included in different computer zone models and it can also be calculated using field models. When

## 2. FIRE SAFETY ANALYSES

the time to critical conditions is an interesting parameter to the problem the computerized models have to be used.

The configuration factor model treats the flame as parallel rectangles. The radiative heat flux is calculated to a point perpendicular to the flames. To calculate the radiation from the middle of the rectangle the flame is divided into four rectangles each contributing to the heat flux at different distances.

The heat flux to the target can then be calculated as follows:

$$\dot{q} = \Phi \cdot \sigma \cdot \varepsilon \cdot (T_1^4 - T_2^4),$$

where  $\Phi$  - the configuration factor,  $\sigma$  - Boltzman's constant ( $5.67 \cdot 10^{-8} \text{ W/m}^2\text{T}^4$ ),  $\varepsilon$  - the emissivity,  $T_1$  - the flame temperature ( $\sim 1200 \text{ K}$ ),  $T_2$  - the target temperature ( $\sim 300\text{K}$ ).

The configuration factor can be calculated using following equation:

$$F_{a1-2} = \frac{1}{2\pi} \left\{ \frac{X}{\sqrt{1+X^2}} \tan^{-1} \left[ \frac{Y}{\sqrt{1+X^2}} \right] + \frac{Y}{\sqrt{1+Y^2}} \tan^{-1} \left[ \frac{X}{\sqrt{1+Y^2}} \right] \right\},$$

where  $X = L1/D$ ,  $Y = L2/D$ ,  $L1$  - flame width (m),  $L2$  - flame height (m),  $D$  - distance to object (m).

When the radiation is calculated from the middle of the flame,  $L2$  is the total flame height divided by two (2) and  $L1$  is the flame width divided by two (2). The total configuration factor is then calculated as:

$$\Phi = 4 \cdot F_{a1-2}.$$

The heat of radiation from a hot gas layer is a more complex procedure and will not be described in this document.

### Flame height

The input to the calculations of flame height is the maximum heat release rate of the fire and the diameter of the fire area. The output is only the height of the flame.

The mean height of the flame according to the Heskestad plume can be calculated with the following formula:

$$L = 0,235 \cdot Q^{0,4} - 1,02 \cdot D$$

where  $D = \sqrt{4A/\pi}$  is the diameter of the fire source (m),  $Q$  is total energy release rate (kW).

### Fire resistance of metallic structures

The relative thickness of metal structure is calculated as:

$$t_{red} = \frac{A}{P},$$

where  $A$  is a cross sectional area of the structure ( $\text{cm}^2$ ),  $P$  – the perimeter affected by a fire (cm).

Then according to the relative thickness the fire resistance time is obtained.

### Manual fire fighting analysis



## 2. FIRE SAFETY ANALYSES

To be able to see if manual fire fighting are able to prevent a fire from disabling redundant equipment or cables a manual fire fighting analysis must be done.

The manual fire fighting analysis is done by comparison the necessary flow of extinguishing media with the flow of flammable gases. Necessary flow of extinguishing media is calculated as follows:

$$m_e = m_f \cdot REMP,$$

where  $m_e$  is the flow of extinguishing media (kg/s),  $m_f$  – flow of flammable gases (kg/s), REMP – characteristic of fire extinguisher (e.g. for powder fire extinguishers REMP=1,5, and for CO<sub>2</sub> fire extinguishers REMP=11).

Flow of flammable gases can be calculated using formula:

$$m_f = \frac{Q}{H_c},$$

where Q is fire effect (kW),  $H_c$  – heat of combustion (kJ/kg).

Available flow of extinguishing media:

$$m_a = \frac{m_c}{t},$$

where  $m_c$  is the mass of fire extinguishing media (kg),  $t$  – time of extinguishing media supply. Usually for fire extinguishers with 5 kg of extinguishing media time of media supply is assumed to be 20 seconds.

When extinguishing with water, the comparison of heat absorption capacity of water with fire effect is done (it is being compared whether spray water can accumulate the fire heat or not). It is known that heat absorption capacity of water is 10.8 MJ/kg.

#### ***Initial information for SWTSF FHA***

Five systems were identified as important to safety:

- Ventilation system;
- Radiological monitoring system\*;
- Handling system;
- Power supply system;
- Fire protection system.

There are a lot of rooms where radiation monitoring equipment (aerosol monitors, whole-body  $\alpha/\beta$  surface contamination monitors, mobile monitors, etc.) are located. It is not reasonable to analyse them, because one part of different monitoring equipment belong to characterization system, which is responsible for product quality only (the system does not perform any safety related tasks). The other part of the equipment belongs to equipment, which performs monitoring functions related to radiological protection of personnel and the population. However, in case of fire personnel will leave facility without using monitors and other monitoring equipment, operations in the facility will be stopped. The priority will be given to save lives. After the fire, all the equipment regardless their importance to safety will be checked and repaired/replaced if necessary. Entry to the facility will be allowed only with permission of radiation safety personnel and using mobile devices. In such a case the analysis is not worthwhile to be performed. However, it is foreseen that methane gas for the Tritium

## 2. FIRE SAFETY ANALYSES

and Noble Gas Monitoring Instrument of the Off-Gas Monitoring (B3KYA10) will be used in the facility. The explosion of this gas is evaluated.

Table 1: List of the main components important (critical) for safety of the selected systems

System	Component name	Tagging	Component location
Ventilation system	Exhaust air fans	B3KLA20AL001A/B	Room 23R031
	Exhaust air fans	B3KLA30AL001A/B	Room 23R031
	Filter units	B3KLA20BT001A/B	Room 23R023
	Filter units	B3KLA20BT002A/B	Room 23R023
	Filter units	B3KLA30BT003A/B	Room 23R018
	Filter units	B3KLA30BT002A/B	Room 23R014
	Filter units	B3KLA30BT001A/B	Room 21R023
Handling system	Gantry crane SLW storage	B4KPH10AE001	Rooms 31R001/31R002/31R004
	Gantry crane LLW storage	B4KPH20AE001	Rooms 41R001/41R002/41R006
Power supply	UPS systems	B3BRH10GS001/005	Rooms 22R075/22R071
	Main distribution UPS	B3BRH10GS101	Room 22R075

### Main assumptions

It is assumed that:

- Only one fire can occur in the facility at one time;
- Lighting is not considered as an ignition source as the facility is equipped with active lightning protection;
- Failure of one component of the fire protection system will not lead to loss of the whole system;
- Due to uncertainties of some data, conservative assumptions are accepted in some compartment FHA.

### Damage thresholds

Equipment and components can be effected by a fire in different ways. In the literature the temperature and heat radiation effects are mainly discussed, because these are the only effects that can be evaluated in a quantitative way.

Damage thresholds for typical equipment are given in the Table 2 and for people in Table 3.

Table 2: Damage threshold for different equipment

Equipment	Critical gas temperature, °C	Critical heat of radiation from, kW/m <sup>2</sup>
Pumps	200-250	8
Motors	200-250	8
Compressors	200-250	8
Electrical equipment	60-70	8
Cables	200-250	8
Carbon steel structure	460	-

Table 3: Heat flux influence on people

Heat flux by thermal radiation*, kW/m <sup>2</sup>	Influence
37.5	100 % lethality after 1 min, 1 % - after 1 second
25.0	100 % lethality after 1 min and serious injuries after 10 seconds
12.5	1 % lethality after 1 min
4.0	Causes pain if exposure is more than 20 seconds; possibility of blisters occurrence is low
1.6	Constant flux does not cause any influence

\* - values for unprotected skin

The highest temperature, which a person can withstand for a long time (> 30 min.) is 60 °C, and heat flux of thermal radiation (~30 sec.) – 2.5 kW/m<sup>2</sup>.

### 2.2.2.3. Fire phenomena analyses: overview of models, data and consequences. Main results.

#### HVAC SYSTEM

The main purpose of the nuclear ventilation system is to:

- Reinforce containment by providing appropriate depressions between areas so that the air always flows into areas of higher contamination;
- Localise of radioactive substances.

Depressions are created using extract ventilation system fans (powered by electro motors), localization (filtration) of radioactive substances is achieved by using appropriate filters. Therefore extract fans and filter units are important to safety. The coding of these elements (filters and fans) is the following B3KLA20, B3KLA30

#### Background

The main extract ventilation system equipment are located in the following rooms (Figure 2.2.2-1, Figure 2.2.2-6):

- Fans B3KLA20AL001A/B – 23R031;
- Fans B3KLA30AL001A/B – 23R031;
- Filter units B3KLA20BT001A/B – 23R023;
- Filter units B3KLA20BT002A/B – 23R023;
- Filter units B3KLA30BT003A/B – 23R018;
- Filter units B3KLA30BT002A/B – 23R014;
- Filter units B3KLA30BT001A/B – 21R023.

#### Fire scenario 1

Figure 2.2.2-1 presents a group of compartments – 23R031/023/018 where a part of ventilation system equipment is located. All these ventilation system compartments are assigned to fire and explosion category Eg. The doors leading from ventilation system rooms to corridor 23R025 are fire doors (FD) with a fire resistance of 30 minutes (EI30).

All these rooms (23R031/023/018) form one fire sub-compartment, which outer walls are made of reinforced concrete with a thickness of 400 mm. The minimum thickness of the walls between the rooms in this fire sub-compartment is 175 mm. This FC has 4 openings (doors) – two from room 23R018 one from room 23R023 and one from room 23R024 (Figure 2.2.2-1). The fire resistance of the walls of this

## 2. FIRE SAFETY ANALYSES

fire sub-compartment is 60 min (REI60; fire resistance of the wall with room 23R029 is REI90). In corridors 23R001 and 23R025 few optical smoke detectors are installed for fast smoke/fire detection and one manual call point (in 23R001) for manual signalization.

These corridors contain mostly cable lines (fire load due to cabling is  $\sim 43.3/42.1$  MJ/m<sup>2</sup>, respectively and rough estimation suggests that fire duration in the corridor could be about 10 minutes). They also contain power cables (cables insulation is made of flame retardant materials), and cables on cable bearer (total fire load – 149.3/390.0 MJ/m<sup>2</sup> and longest fire duration up to 30 minutes), which are laid above the suspended ceilings (for fire/smoke detection optical smoke detectors are also installed in the suspended ceilings). In the corridors the suspended ceiling structures have fire resistance rating REI90 (can resist fires for 90 minutes without losing insulating, integrity and load bearing properties and therefore in comparison with design fire duration is fully sufficient). The corridors are equipped with portable carbon dioxide fire extinguishers (5 kg of extinguishing substance each) and fire cocks for manual fire fighting.

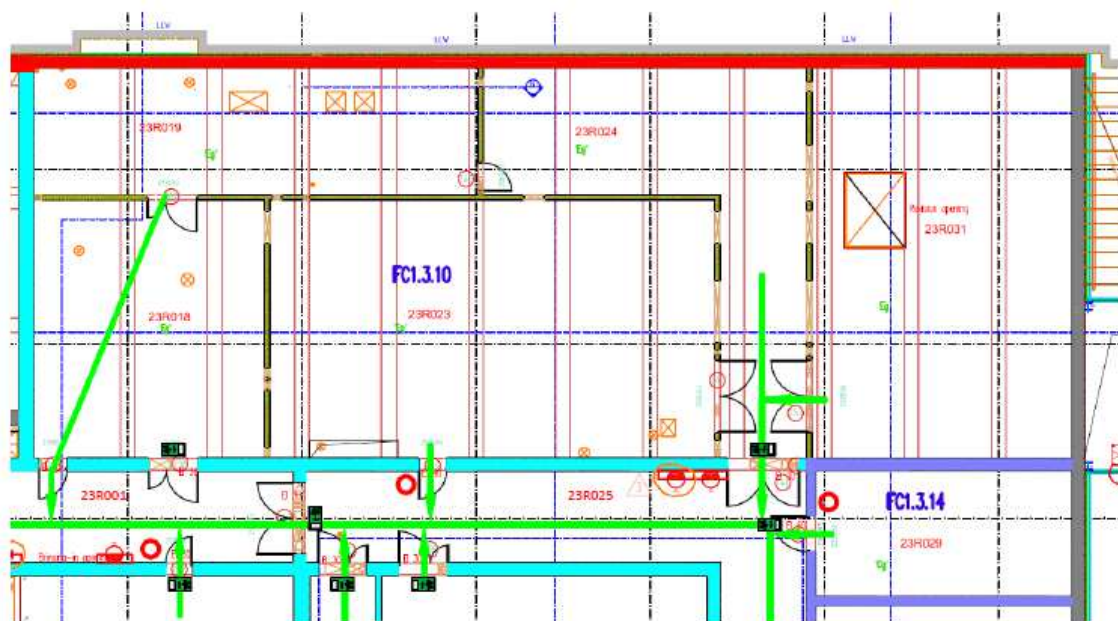

Figure 2.2.2-1. Fire sub-compartments of the ventilation system rooms 23R031/023/018

Filters (KLA20BT001A/B and KLA30BT003A/B) are important to safety. They are located in stainless steel filter units (Figure 2.2.2-2) in the compartments – 23R023 and 23R018 (see Figure 2.2.2-1 and Figure 2.2.2-3). These rooms are equipped with automatic fire detection system (smoke detectors are installed) however there are no manual fire fighting means. Manual fire extinguishers (3 pcs. CO<sub>2</sub>, 5 kg each of extinguishing media) are placed in nearby located corridor 23R025. The only fire source are mainly the electrical cables (total amount 10 kg in each room; however cables insulation is made of flame retardant materials), which supply power to the ventilation equipment and which are placed in metallic cable trays. Besides, there are no other materials in the compartment which could ignite/could be ignited and could result in rapid fire growth. As filters are placed in stainless steel filter units, they are also prevented from any influence from outside.

## 2. FIRE SAFETY ANALYSES



Figure 2.2.2-2. View of filter unit

In the adjacent rooms 23R019 and 23R024 there is the LLW storage ventilation system located (it is located near the outer wall of the rooms 23R019/024, i.e. further from the rooms 23R018/023). Fire loads in these rooms are mainly due to cables and are approx. 40 and 106 MJ/m<sup>2</sup>, respectively. Due to the surroundings of these rooms (concrete) any fire will be local and will not spread to the ventilation equipment rooms – 23R023 and 23R031.

Besides, if fire occurs in rooms 23R019 and 23R024 (fire in the rooms could be detected fast, as both rooms are equipped with smoke detectors) it can be extinguished with available fire extinguishers located in corridor 23R025. If to assume, that 5 kg fire extinguisher discharge time is approx. 20 seconds, then, with such extinguisher a fire of electrical equipment (heat of combustion 16400 kJ/kg) equal to 186 kW can be extinguished using one fire extinguisher with an efficiency of 50 %. For example, 1 m<sup>2</sup> of cable fire gives 186 kW, large electrical cabinet fire (containing in total about 60 kg of insulation, wiring, relays, etc.) gives approx. 200 kW.

**Fire scenario 2**

Two extract fans 30AL001A/B and two extract fans 20AL001A/B of safety important systems B3KLA20 and B3KLA30 are located in the compartment – 23R031. Fans are equipped with electrical motors. The shortest distance between the motors of different important systems fans B3KLA20 and B3KLA30 is approx. 2.5 m.

Fire can occur (e.g. due to overload or short circuit) in one of the electrical motors of the system and the other important system/motor (Figure 2.2.2-3) can be damaged.

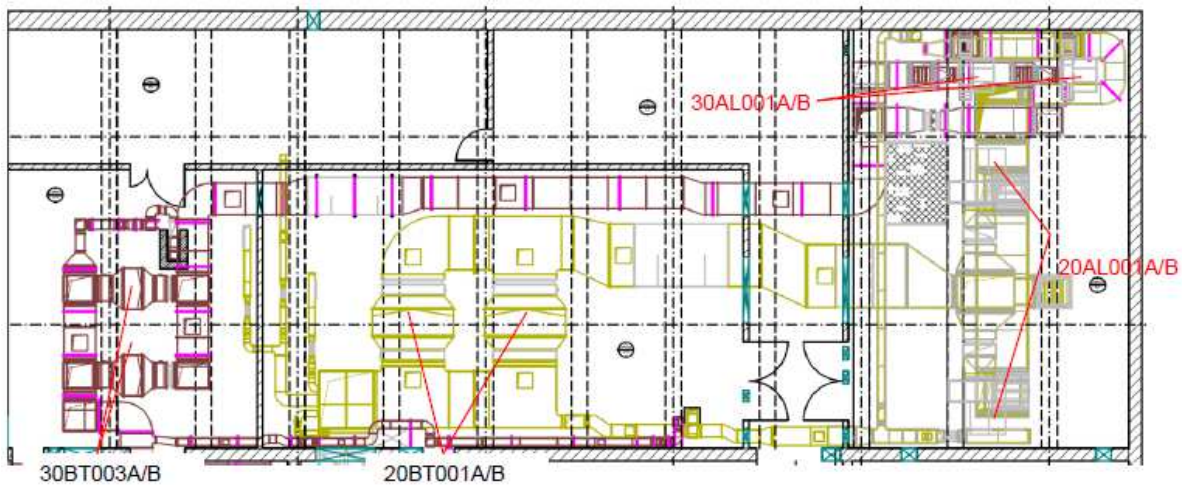

Figure 2.2.2-3. Ventilation fans and filters area

Motors (Figure 2.2.2-4) of the fans are closed (in housings) and in case of fire they will not burn with an open flame. Besides, motors are equipped with overload protection and have revolution measurement devices. The signals on the motor/fan parameters are transferred to control room and are permanently controlled by the building management system.

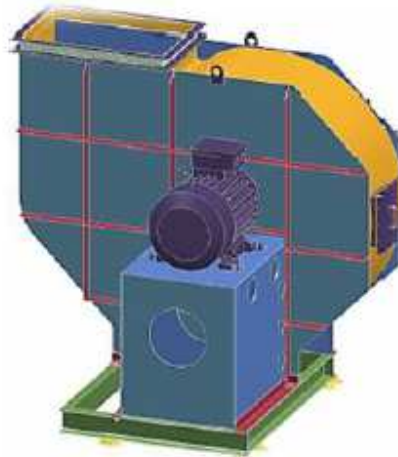

Figure 2.2.2-4. Fan with electrical motor

However, it is conservatively assumed that the bigger motor (of system B3KLA20) starts to burn with an open fire, so the motor of the other system could be affected by thermal flux radiation and can be damaged.

The exact quantity of combustible materials of electrical motor is not known (producers do not indicate such parameters; motor power is 90 kW), therefore it is conservatively assumed that the bigger motor (system B3KLA20) contains approximately 10 kg combustible material, e.g. cables and electrical wiring.

It is also assumed that the heat release rate in a motor is constant and never exceeds the heat release rate of a cable tray ( $186 \text{ kW/m}^2$ ) fire of the same size as the motor fundament, i.e.  $\sim 1.5 \text{ m} \times 1 \text{ m}$  (conservative assumption, in fact fundament is of less dimensions – about  $0.7 \times 1 \text{ m}$ ). So, heat release rate of the electrical motor, used in calculations, is 279 kW ( $186 \times 1.5$ ).

## 2. FIRE SAFETY ANALYSES

The flame temperature used in the calculations is 1000 °C. The temperature in the room is 20 °C. Heat of combustion of electrical equipment is equal to 16400 kJ/kg and it is assumed that combustion efficiency is 0.7. Fire duration, with a constant heat release rate will be:

$$t = \frac{\chi \cdot m \cdot \Delta H_c}{Q} = \frac{0.7 \cdot 10 \cdot 16400}{279} = 411 \text{ s (or approx. 7 min).}$$

Flame height will be:

$$L = 0.235 \cdot 279^{0.4} - 1.02 \cdot 1.38 \approx 0.84 \text{ m.}$$

Heat flux to the target can be calculated from the following expression:

$$q = \Phi \cdot \sigma \cdot \varepsilon \cdot (T_1^4 - T_2^4),$$

where  $\Phi$  – configuration factor,  $\sigma$  – Boltzman's constant,  $\varepsilon$  – emissivity,  $T_1$  is the flame temperature (1200 K),  $T_2$  is the target temperature (293 K).

Then thermal flux of radiation in 2.5 m distance is only 4.7 kW/m<sup>2</sup> (in fact it will be lower as there are some ventilation ducts in the distance between these motors located; these metallic ducts will act as a shield and will limit/lower the thermal exposure).

So the heat of thermal radiation from a fire in the electrical motor to the adjacent motor is 4.7 kW/m<sup>2</sup> and the exposure time is rather short – only approx. 7 min. Since the damage threshold of different electrical equipment/motors is 8 kW/m<sup>2</sup>, therefore the motor of the other system will not be damaged. Besides, there are no other materials in the room which could cause fire growth or spread and due to large volume of the room (~500 m<sup>3</sup>) no high temperature is expected in the room. The available quantity of fire extinguishers placed in the corridor 23R025 is sufficient to extinguish the design fires in room 23R031.

Adjacent room located near fans room and having the highest fire load is Electrical room 23R029. Room 23R029 and fans room 23R031 are separated by 400 mm (as shown in Figure 2.2.2-1) thickness reinforced concrete wall. According to fire load (711 MJ/m<sup>2</sup>) in the room 23R029 such fire load can result in fire duration of approx. 47 minutes. It is known that the wall separating these two rooms has a fire resistance REI90 and therefore is sufficient. Fire resistance of room doors (leading to corridor, which has no any safety related equipment in it) is 60 minutes (EI60) and is sufficient, since duration of possible fire is shorter.

If fire occurs in room 23R029 it will not spread to ventilation fans room and will be noticed immediately as the room 23R029 is equipped with smoke detectors. Besides, if any fire occurs in the facility, all the non-fire involved rooms are ventilated normally, ventilation of fire involved rooms is stopped, technological processes are also stopped.

### Fire scenario 3

Safety important ventilation system filters are also located in stainless steel filter units in room 23R014 (Figure 2.2.2-5, Figure 2.2.2-6).

The walls (concrete, with a thickness of 400 mm), ceiling and floor (also made of concrete) of room 23R014 are coated with epoxy coating. This room is assigned to Cg category according to fire and explosion hazard. Fire load in the room 23R014 is approx. 57.9 MJ/m<sup>2</sup>.

## 2. FIRE SAFETY ANALYSES

Room 23R014 together with rooms 23R006 and 23R017 for a fire sub-compartment which walls have fire resistance REI60 and fire doors leading to corridor 23R001 - EI60, the fire doors leading to other part of corridor are EI30.

In corridor 23R001 few optical smoke detectors are installed for fast smoke/fire detection and one manual call point for manual signalization. As mentioned earlier, this corridor contain mostly cable lines (fire load due to cabling is  $\sim 43.3 \text{ MJ/m}^2$ , rough estimation suggests that fire duration in the corridor could be less than 10 minutes).

There are no manual fire-fighting means located in 23R014, neither in rooms 23R006 and 23R017. Manual fire extinguishers and fire cocks are placed in corridor 23R001 (3 pcs. CO<sub>2</sub> fire extinguishers; 5 fire cocks).

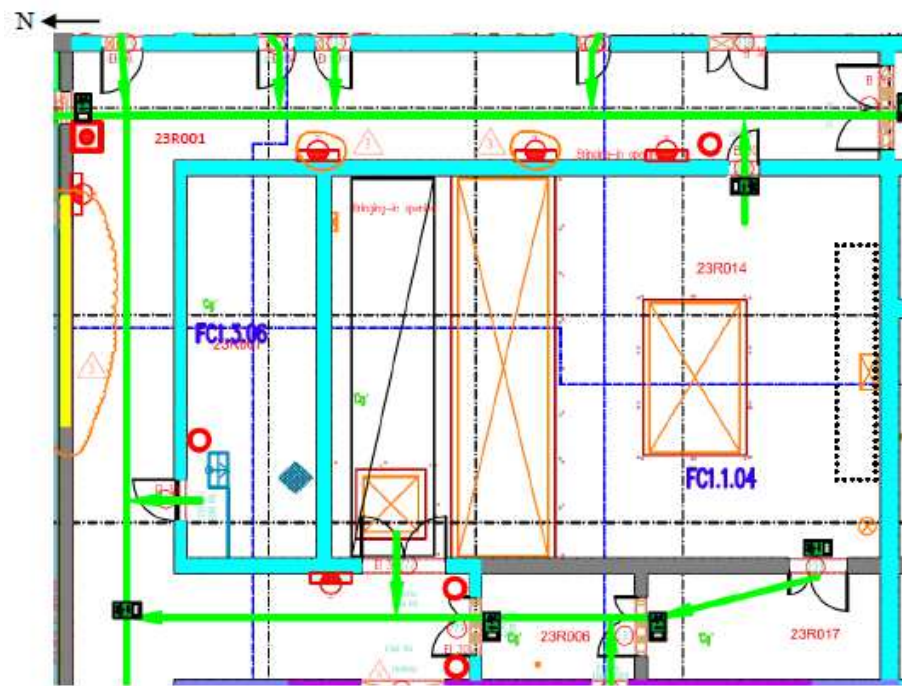

Figure 2.2.2-5. Fire sub-compartment of G2 maintenance room 23R014 (location of filters are indicated with dotted line, see also Figure 2.2.2-6)

There is a crane in the room 23R014 (Figure 2.2.2-7; at approx. 4.4 m above the room floor), which is used to remove floor openings (concrete covers – approx. 400 mm) and to extract equipment from G2 cell into room 23R014 for maintenance (so the equipment in room 23R014 is used mostly during maintenance periods). The crane is driven by electrical motors. These could be the only fire/ignition sources in the room. Important filters of the ventilation system are located in the southern part of the room – in the stainless steel filter housings (similar as shown in Figure 2.2.2-2) located at the lower part of the room (Figure 2.2.2-7).



## 2. FIRE SAFETY ANALYSES

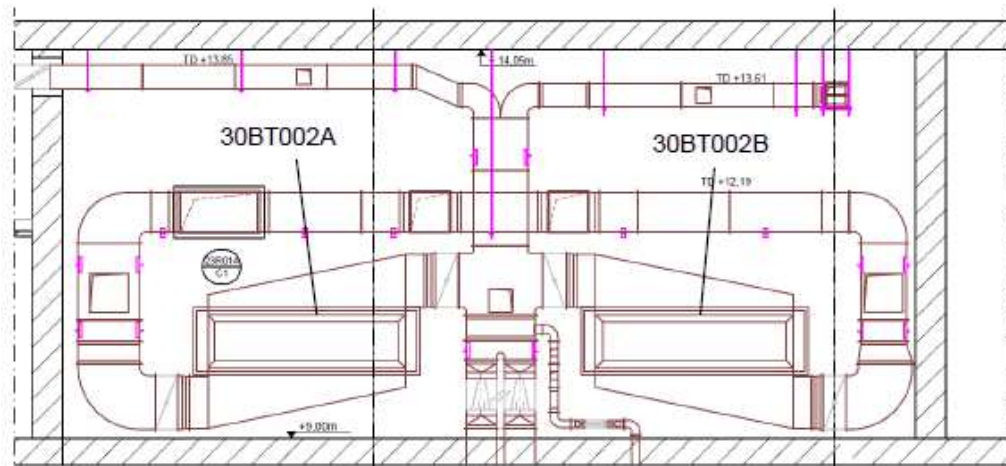

Figure 2.2.2-6. Room 23R014 front view at the wall where the filters are located

Due to fire in the crane motor (even to assume conservatively that crane motor dimensions are ~1.5 m x 1 m and it contains 10 kg of combustible materials, the heat release rate of the electrical motor will be 279 kW and fire duration of about 7 minutes – as assessed in the other scenario above) the exposure heat flux to the stainless steel filter units will be 3.6 kW/m<sup>2</sup> (distance between crane and filter units is ~2.9 m) and therefore will not be damaged. Besides, electrical motors of the crane have housings, and are equipped with over voltage protection. In case of fire, electrical motor may produce some smoke, but not open flame, therefore the adjacent equipment and filters cannot be damaged (besides crane is operated only when the personnel is in the room). When the crane is not in use, it is disconnected from the power supply, thus reducing a risk of fire occurrence.

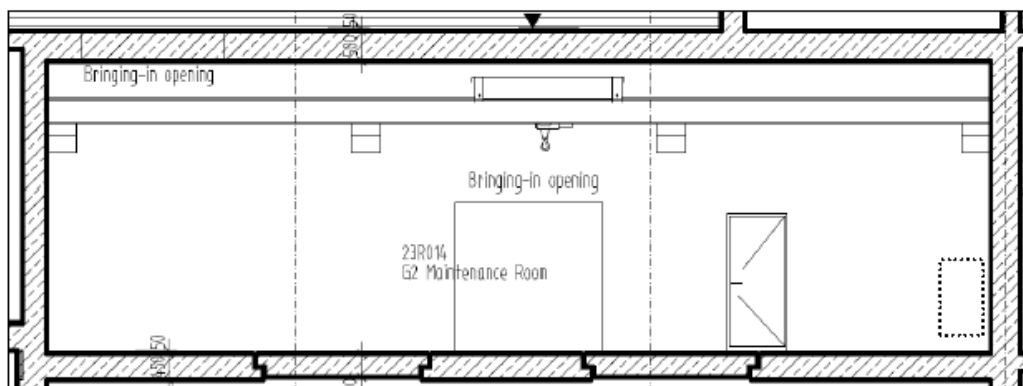

Figure 2.2.2-7. Room 23R014 (view for information only)

It should also be mentioned that the filters in room 23R014 are “primary filters” as the air extracted by the same extraction line also passes other “additional” filters located in room 23R018 (see Figure 2.2.2-3, filters 30BT003A/B).

The available quantity of fire extinguishers placed in nearby corridors is sufficient to fight possible fires in room 23R014.

#### Fire scenario 4

Room 21R023 – G3 sorting cell contains the following equipment – the crane (equipped with electrical motors), few remotely controlled hydraulic manipulators, conveyor and a shredder. The room is also equipped with primary filters of the ventilation system B3KLA30 (see Figure 2.2.2-8).

## 2. FIRE SAFETY ANALYSES

Fire can occur in the electrical motors of different equipment, may expose and/or ignite the adjacent equipment and also can damage safety important filters (in filter units) of the extract ventilation system, which are located at the G3 cell ceiling.

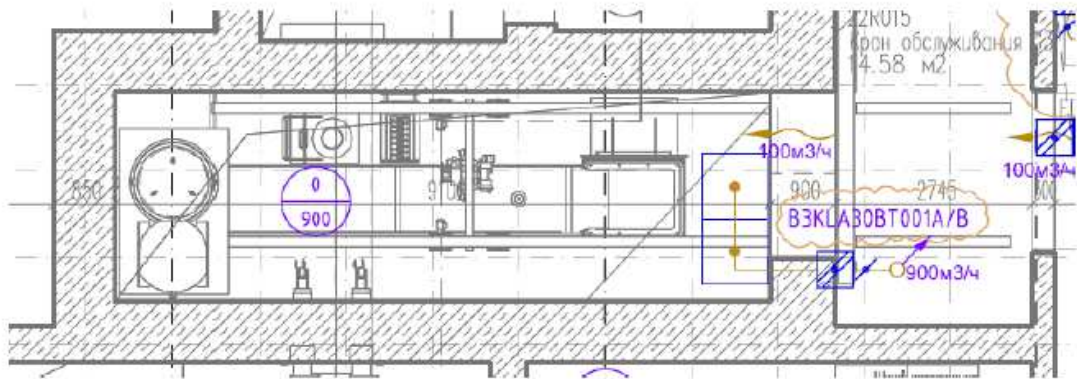

Figure 2.2.2-8. Location of filters 30BT001A/B in G3 sorting cell (for information only)

G3 sorting cell is a sealed room. Walls are made of reinforced concrete and a minimum wall thickness is 700 mm. Floor is covered with steel plate, walls and ceiling – with epoxy coating. All sorting operations that take place within the G3 sorting cell are performed remotely using a combination of the cell crane and manipulator arms (Figure 2.2.2-9). In G3 cell there is also a belt conveyor and a shredder installed. Fire load in G3 cell is 56 MJ/m<sup>2</sup> (area is 26.4 m<sup>2</sup>), mainly due to wall coating and electrical equipment – motors and cables. Room is assigned to Cg category according to fire and explosion hazard and it is equipped with smoke detectors. Exhaust ventilation system extract line before the secondary filtration level is equipped with a fire damper, which closes automatically in case of fire on the signal of the smoke detector installed in G3 cell. There are also secondary filters located in room 23R018 on this extract ventilation system line (see Figure 2.2.2-3, filters 30BT003A/B).

The possible fire sources in G3 cell are electrical motors and cables. In fact, the electrical equipment used in G3 cell is of safe design – motors have overload and short circuit protections. Motors are in metal housings; therefore in case of fire they will not tend to burn with an open flame. Cables used in G3 cell (as well as in all the facility) have flame retardant insulation. In case of fire G3 cell electrical equipment may produce only some smoke (the sorted wastes are non-combustible waste), but will not burn with an open flame, therefore will not damage ventilation filters placed far above from other equipment (more than 4 meters from other equipment in the cell).

During sorting operations the cell is supervised by operators directly, via shielded window and via video cameras. So any emergencies will be noticed immediately and appropriate action will be taken as soon as possible (e.g. disconnection of power supply to the handling equipment in the cell).

## 2. FIRE SAFETY ANALYSES

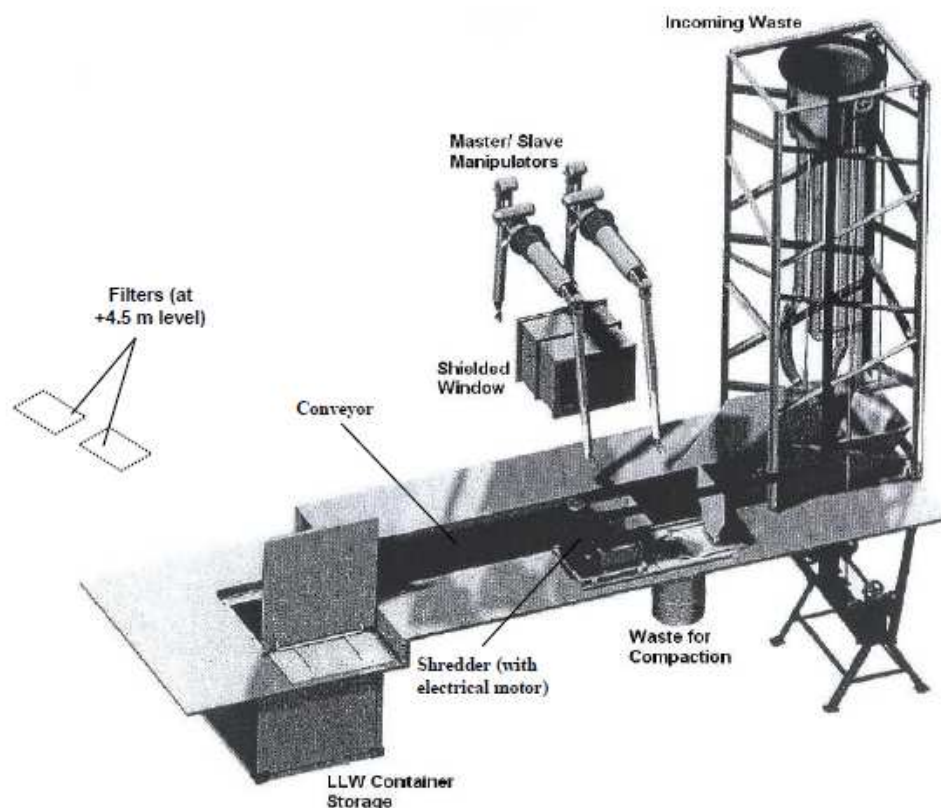

Figure 2.2.2-9. Main equipment in G3 sorting cell (crane is not shown; it is located near the ceiling of the G3 cell (distance from conveyor to crane is approx. 6 m)

It is possible that due to sorting operations some dust may occur and therefore the fire detector installed in G3 cell might be affected by dust. Therefore, it is necessary to take this into account during facility operation.

#### MONITORING SYSTEM (FOR OFF-GAS) B3KYA10

Emission control room 24R014 contains important equipment for chemical and radiological emissions monitoring (sampling equipment, different detectors, etc.). At first, the analysis is made in a form of discussion, which purpose is to determine the influence on equipment from the fire in the adjacent rooms.

It is also foreseen that methane gas for the Tritium and Noble Gas Monitoring Instrument of the Off-Gas Monitoring (B3KYA10) system using in room. Then the explosion possibilities of this gas are evaluated.

#### Fire scenario 1

Room 24R014 (Figure 2.2.2-10) is assigned as category Cg according to fire and explosion hazard. It is a fire sub-compartment with fire resistance of EI60. Room surroundings are made of concrete. The floor is coated with epoxy coating, walls and ceiling are painted. Fire load (mainly due to monitoring equipment, cables and floor coating) is approx. 600 MJ/ m<sup>2</sup>.

The most thickness of the walls is 400 mm, the least – 175 mm. Room has one fire door (resistance 30 minutes), which leads to corridor 24R003. Fire load in the corridor is only 43 MJ/ m<sup>2</sup>, due to cables (cables used in the facility have flame retardant coating), which are laid above the suspended ceiling

## 2. FIRE SAFETY ANALYSES

(suspended ceiling structures have fire resistance REI90). So there are no other ignition sources in the corridor. Corridor is equipped with a few smoke detectors and a manual call point, besides there are carbon dioxide fire extinguishers (5 kg of extinguishing substance each) located in it.

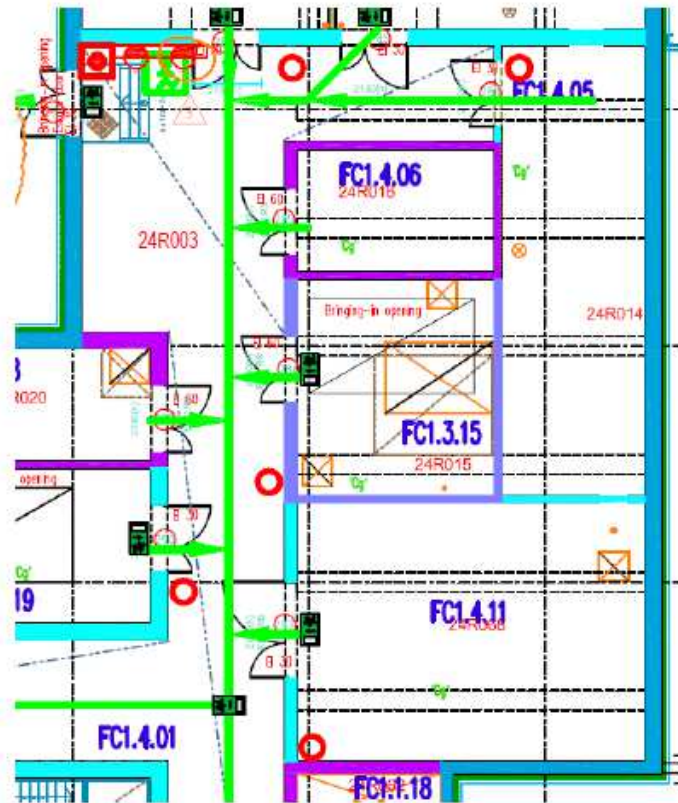

Figure 2.2.2-10. Fire sub-compartment of Emission control room 24R014 (top view)

Compartments 24R015, 24R016 and 24R068 are also adjacent to room 24R014. Fire load in 24R015 is approx.  $59 \text{ MJ/m}^2$  (due to cabling and electrical equipment) and in room 24R016 –  $2167 \text{ MJ/m}^2$  (due to cabling and filter material). Fire load in room 24R068 is not defined as it will depend on quantity of the stored materials (as it is a storage of spare parts). In any case in order to exceed fire rating of the walls REI60, fire load should exceed  $900 \text{ MJ/m}^2$  (which is rather high fire load). Besides, there are no potential ignition sources in this room.

There are smoke detectors installed in all adjacent rooms, and there are manual fire fighting means –  $\text{CO}_2$  fire extinguishers (manual fire fighting means are also located in corridor 24R003 and can be used if necessary). There is one door from room 24R015 (fire resistance of the door is EI60 and the structures of this room have fire resistance REI90), one door from room 24R016 (fire resistance EI60) and one door from room 24R068 (fire resistance of the door is EI30 and the structures of this room have fire resistance REI120) leading to corridor 24R003. All these doors are closed (have self-closing mechanisms). If fire somehow occurs in these compartments, fire duration could be (without any manual fire extinguishing activities) about 15 minutes in room 24R015, about 135 minutes in room 24R016 (however there are no potential ignition sources in these rooms). It is unlikely that fire in room 24R068 could last more than room walls can resist (in any case fire fighting will be manually started by operators and/or by VFRS and will be suppressed). So this means that fire resistance of the walls of these rooms is sufficient (approx. 60 min) and fire will not spread to off-gas monitoring room 24R014.

## 2. FIRE SAFETY ANALYSES

Ventilation system ducts in rooms 24R015 and 24R016 have no connections to room 24R014. Ventilation system ducts between 24R068 and room 24R014 have a connection: the air goes from 24R068 to 24R014 and then is sucked-off.

**Fire scenario 2**

The methane gas is used for Tritium and Noble Gas Monitoring Instrument of the Off-Gas Monitoring in room 24R014. The methane will be provided from 4 pressure gas bottles located in the Gas Storage (which is outside the SWTSF building). A primary pressure reducer is mounted in the gas storage to reduce the outlet pressure from a gas bottle from 200 bar (2MPa) to operational pressure of 1.5 bar (150 kPa) maximum. An additional pressure regulator and valve is installed in room 24R014 close to the tritium monitor.

Methane is a flammable, colorless, odorless, compressed gas delivered in 50 liter bottles under high pressure (200 bar). Methane is lighter than air. Released methane poses an immediate fire and explosion hazard when mixed with air at concentrations between the Low Explosion Level (LEL) of 4.4 % and High Explosion Level (HEL) of 16.5 % (by volume). Therefore, if released to room 24R014, methane with air can generate explosive concentration and can cause explosion.

Conservative scenarios of methane gas explosion risk in room 24R014 were evaluated:

1. In the 1st scenario the impact of a small hole leakage of the methane gas line was be evaluated. The main cause for this type of leakage could be generally an insufficient or imperfect sealing of fittings. The conservative evaluation showed that as the room ventilation ensures 1.3/h air exchange rate (room 24R014 volume is approx. 194 m<sup>3</sup>), it is sufficient enough to dilute the released methane gas below the LEL permanently. Therefore such scenario does not cause explosion of the gas.
2. In the 2nd scenario the impact of an open gas line at operating pressure was be evaluated. The main cause for this type of event could be the accidental disconnection of tritium monitor while the gas line is open. It was also assumed that the quick connector with auto shut-off of the flexible plastic hose facing the gas line either fails or this is not implemented at all. It was obtained that the ventilation is not efficient enough to dilute the released methane below the LEL permanently as the 50 l methane bottle (~12.6 m<sup>3</sup> of methane) will be released into the room during 8 minutes.
3. In the 3rd scenario the impact of an open methane gas line at maximum pressure was evaluated. The main cause for this type of event could be that the tritium monitor is not connected to the gas line (e.g. flexible plastic hose has ruptures) and pressure regulators are fully open. In this case it was also concluded that ventilation is not capable to dilute the one-time (in almost half a minute) released methane below the lower explosion limit permanently.

It was also shown that maximum explosion pressure occurs when the concentration of methane is ~10% (in the analysed scenarios concentration will be lower) and in such case explosion pressure (absolute) is about 9 bars (900 kPa), which is very high and may cause damage to equipment/building. Therefore it is necessary to avoid release of methane gas in room.

For avoiding an explosion risk it is essential to have a methane gas sensor installed in the proximity of the ceiling for monitoring the methane concentration of the room 24R014. The gas sensor would give alarm at 10 % of LEL which allows to check the methane gas system with e.g. a portable gas sensor for leakages.

If the methane gas concentration exceeds 20 % of LEL the gas sensor triggers a shutdown of the methane gas system.

Another effective countermeasure is installed an excess flow valve which shuts down the gas line in case the pressure exceeds a given threshold eliminating scenario 3 completely. As a counter measure

## 2. FIRE SAFETY ANALYSES

would be an extra gauge valve in the gas shed with a fixed setting of a given maximum pressure. This valve should be secured with a valve lockout for avoiding any tampering of the maximum gas pressure. In the facility the fixed tubing connecting the tritium monitor with the gas line is used. This solution eliminates the risk of accidentally pulling off the flexible gas hose (scenario 2 and 3).

**HANDLING SYSTEM**

Handling system (transportation, sorting, etc.) equipment assures all movements in the SWTF, which are necessary for the handling of drums, containers and operating materials. The main items of these systems are electrically driven roller conveyors, cranes, transfer cars and hydraulic manipulators.

The design of electrical motors is fire safe, i.e. they are in metallic housings, motors are equipped with winding temperature monitors and have overload protection (i.e. are implemented measures, which reduce fire occurrence risk).

Hydraulically driven handling equipment is provided with signalization of the leak in hydraulic systems. To avoid additional fire loads, flame resistant hydraulic oil is used for hydraulic devices. In order to avoid leakages of equipment, which contains liquids (e.g. oil), bunds with sump (where necessary) are provided. Sumps are equipped with level switches. Vulnerable hydraulic cylinders are placed in protective covers.

Cabling used for handling equipment power supply have coating, which resistance to fires is increased.

Operating and maintenance personnel of departments, which are in charge of operating and maintenance of the system, according to the procedures, carry out periodic handling system maintenance, thus reducing the risk of equipment failures.

The following components were identified as important to safety of the handling system:

- Gantry crane B4KPH10AE001 of SLW storage – rooms 31R001/31R002/31R004;
- Gantry crane B4KPH20AE001 of LLW storage – rooms 41R001/41R002/41R006.

**Fire scenario 1**

SLW storage is a separate fire compartment, which walls are made from reinforced concrete and have a thickness of about 60 cm and are designed to resist fires for not less than 180 minutes (Figure 2.2.2-11).

## 2. FIRE SAFETY ANALYSES

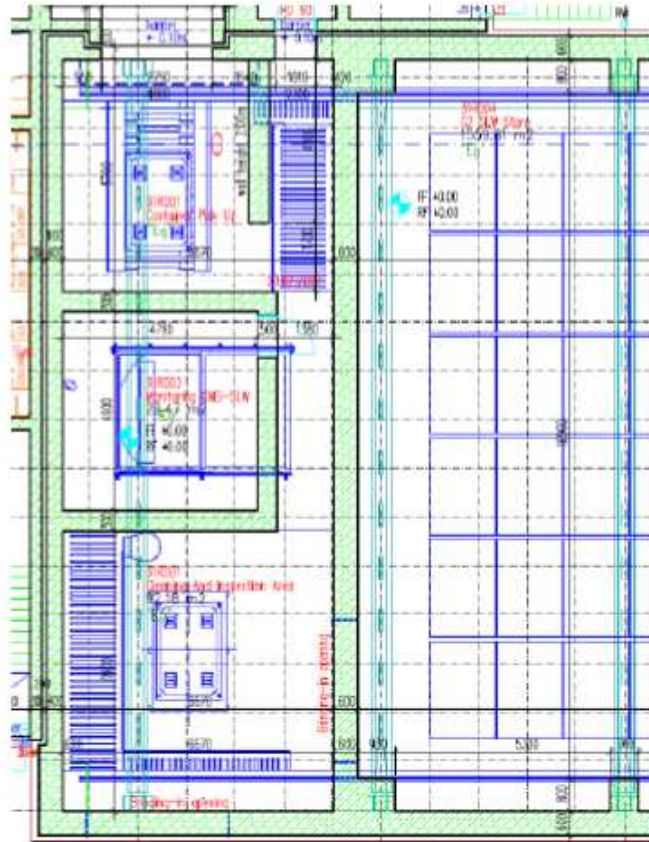

Figure 2.2.2-11. Fragment of rooms 31R001/31R002 and 31R004

The storage room 31R004 (incl. Cleaning and Inspection area/Container Pick – room 31R001 and Container monitoring system – room 31R002) is a rather big building (see Figure 2.2.2-11). The outer dimensions of this building are ~94×20×14 m. It has an opening to the treatment building – fire door which has fire resistance EI90. Normally door is always closed and is opened only for a short time when it is necessary to transfer grouted container from treatment building to storage building. During normal operation personnel access is also not allowed to the storage. According to fire and explosion hazard the storage (incl. rooms 31R001/31R002) is assigned to category Eg. There are no materials in these rooms which could result in rapid fire growth.

In all these three rooms (31R001/31R002/31R004) only grouted waste which are placed in reinforced concrete container (wall thickness about 15 cm) is handled. There are no fire detection, nor fire extinguishing means in these rooms. The operations are directly observed by operators using video cameras.

The crane which handles containers is located in the upper part of the storage, as shown in Figure 2.2.2-12.

## 2. FIRE SAFETY ANALYSES

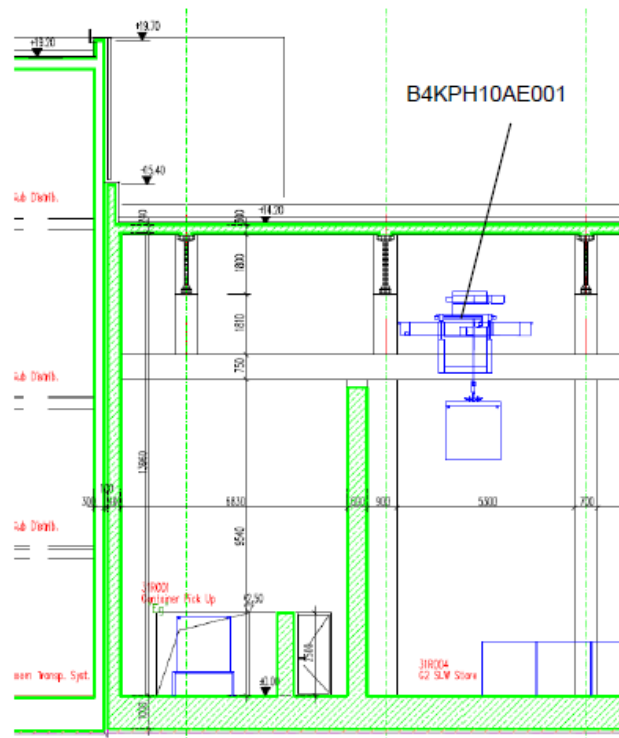

Figure 2.2.2-12. Fragment of SLW storage (side view)

Fire loads in these rooms are negligible – highest fire load does not exceed  $120 \text{ MJ/m}^2$ . From the potential fire sources only motors of the conveyors (see Figure 2.2.2-11) could be taken into account.

If to assume that conveyor motor dimensions are the same as used for motor in ventilation system analysis (2.3.2 sect.) and take into account that crane is located about 9 m directly above fire source, the temperature in the centerline of the design fire at such distance will be  $19.4 \text{ }^\circ\text{C}$ . So if the ambient temperature is  $20 \text{ }^\circ\text{C}$ , the exposure temperature to the crane will be  $39.4 \text{ }^\circ\text{C}$ , which is much lower than electrical/metallic (e.g. crane structures) damage threshold. Due to short fire duration (7 min.) no high temperatures are expected in this facility.

What concerns handled container, the comparison of fire resistance of respective thickness reinforced concrete wall, shows that 125 mm thick wall ensures fire resistance for about 180 minutes. So it can be assumed that container (wall thickness 150 mm) has similar resistance. Since the design fire of electrical motor lasts for few minutes, it means that the container/radioactive waste located inside the container will not be affected by fire and no radiological releases will occur.

### Fire scenario 2

LLW storage is a separate fire compartment, which external walls are made from reinforced concrete and have a thickness of about 1.3 m (thickness of internal walls is 800 mm) and are designed to resist fires for not less than 180 minutes (Figure 2.2.2-13).



## 2. FIRE SAFETY ANALYSES

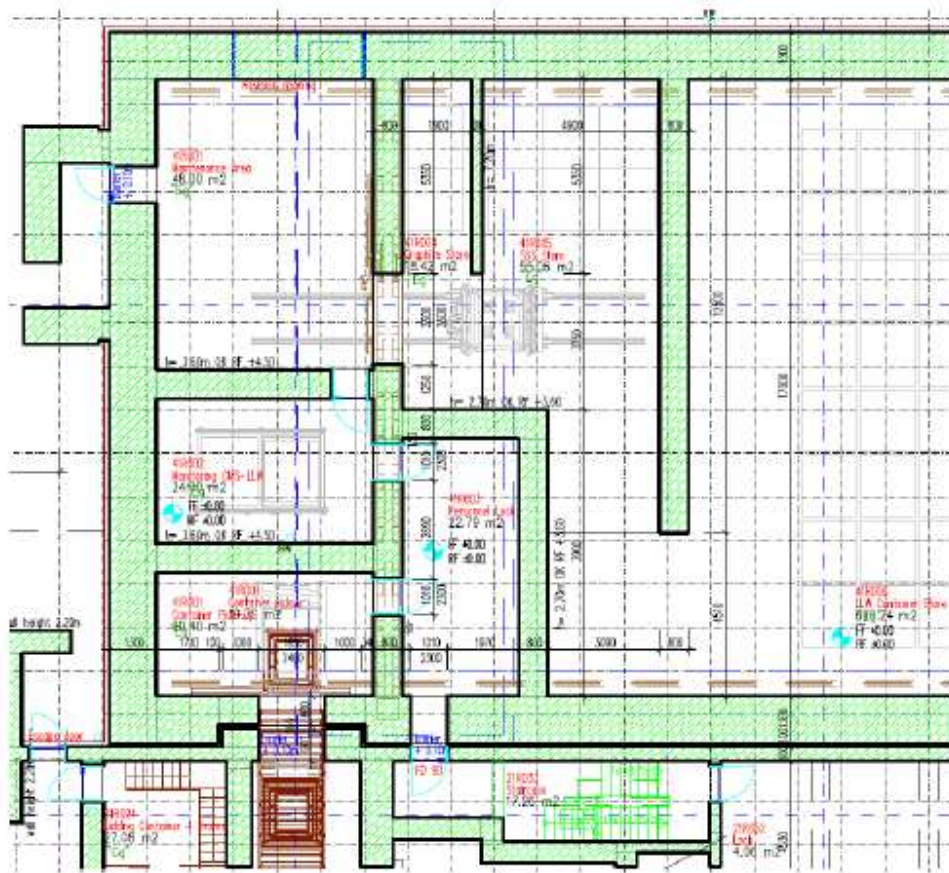

Figure 2.2.2-13. Fragment of LLW storage (top view)

The storage (incl. maintenance/pickup area – room 41R001 and container monitoring system room 41R002, personnel lock 41R003) is a rather big building (Figure 2.2.2-13). The outside dimensions of this building are  $\sim 57 \times 20 \times 12$  m. It has two openings to the treatment building – fire doors which have fire resistance EI90. Normally doors are always closed and are opened only for a short time when it is necessary to transfer metallic container with waste from treatment building to storage building and in case when it is necessary for personnel to enter the lock 41R003. During normal operation personnel access is not allowed to the storage area rooms. According to fire and explosion hazard the storage (incl. related rooms) is assigned to Eg category. There are no materials in these rooms which could result in rapid fire growth.

In all the rooms (41R001/41R002/41R004-41R006, Figure 2.2.2-13) only the waste which are placed in metallic container (total wall thickness about 15 mm) is handled. There are no automatic fire detection, nor fire extinguishing means in these rooms. The operations are directly observed by operators using video cameras. A manual call point is installed in Personnel lock (41R004).

Fire loads in these rooms are negligible – highest fire load does not exceed  $160 \text{ MJ/m}^2$ . From the potential fire sources only motors of the conveyors and the trolley (see Figure 2.2.2-14) could be taken into account.

If to assume that conveyor/trolley motor dimensions are the same as used for motor in ventilation system analysis (2.3.2 sect.) and that crane is located about 8.2 m directly above fire source, the temperature in the centerline of the design fire at such distance will be  $\sim 23 \text{ }^\circ\text{C}$ , so if ambient temperature is  $20 \text{ }^\circ\text{C}$ , the

## 2. FIRE SAFETY ANALYSES

exposure temperature to the crane will be  $\sim 43\text{ }^{\circ}\text{C}$  which is much lower than electrical/metallic (e.g. crane structures) damage threshold. Due to short fire duration (7 min.) no high temperatures are expected in this facility.

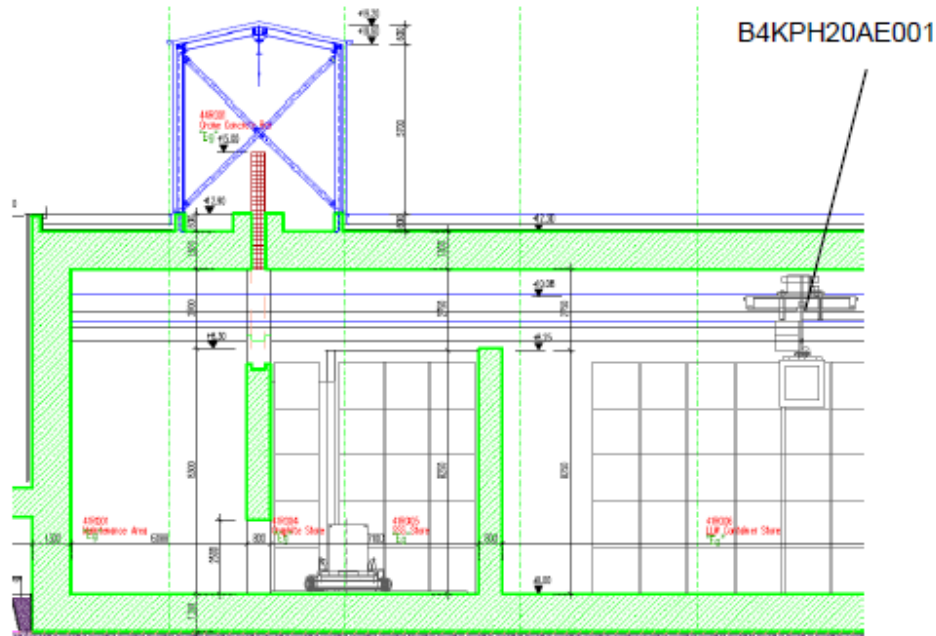

Figure 2.2.2-14. Fragment of LLW storage (side view)

What concerns handled container, the comparison of fire resistance of respective thickness carbon steel sheet, shows that 15 mm thick carbon steel sheet (critical temperature for steel is  $460\text{ }^{\circ}\text{C}$ ) can ensure fire resistance up to 15 minutes. Since the design fire of electrical motor lasts for about 7 minutes, it means that the container/radioactive waste located inside the container will not be affected by fire and no radiological releases will occur.

### POWER SUPPLY SYSTEM

Safety related task of the power supply system, as the support system, consists in providing the safety related systems with electric power supply in such a way, that they are able to perform their safety functions. In case of loss of main power supply, important systems are fed a period of time by uninterruptible power source (UPS). On loss of electrical power the plant and process systems will fail to a safe state but the UPS (and its distribution system) will immediately take over the load to enable the plant monitors, alarms etc. to remain active. System is limited to 1 hour. The UPS supply is provided to instruments and equipment whose operation is vital to the monitoring, alarms, plant interlocking, radiological protection instruments, limited communications equipment etc.

The cables used for power supply are made of non-flammable materials, cable insulation is fire retardant.

The following main components were identified as important to safety:

UPS systems B3BRH10GS001/005 - room 22R075/22R071;

Main Distribution UPS B3BRH10GS101 – room 22R075.

## 2. FIRE SAFETY ANALYSES

**Fire scenario 1**

As it was described before, UPS/distribution system is important to safety. The aim of the analysis is to discuss possibilities for fire to spread from outside to rooms, where UPS are located.

Standby power supplies is in the form of a battery backed UPS systems, which are located in room 22R075 and room 22R071 (Figure 2.2.2-15).

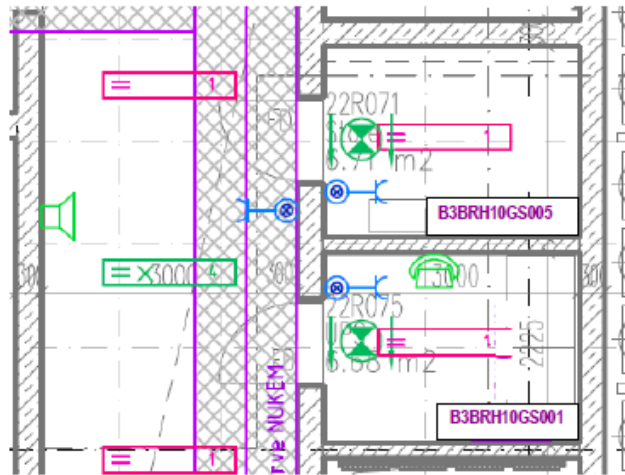

Figure 2.2.2-15. Location of UPS/distribution systems in rooms 22R075/22R071

Room 22R075 is designed as a fire sub-compartment (area 6.7 m<sup>2</sup>, height – 4.15 m). Its surroundings are made of reinforced concrete with a fire resistance of REI120 (Figure 2.2.2-16). There is one portable carbon dioxide fire extinguisher (5 kg of extinguishing media) provided in the room for manual fire fighting and for fire/smoke detection there are optical smoke detectors installed at the ceiling of this room.

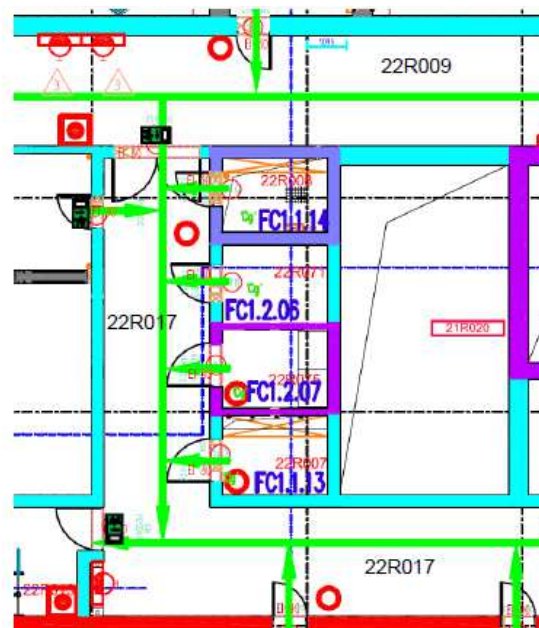

Figure 2.2.2-16. Fire sub-compartments – rooms 22R075/22R071

## 2. FIRE SAFETY ANALYSES

Room has one opening – fire door (resistance EI60), which leads to corridor 22R017.

Another room 22R071 is also a fire sub-compartment (area 6.7 m<sup>2</sup>, height – 4.15 m). Its surroundings are made of reinforced concrete with a fire resistance REI60. There are no manual fire fighting means in this room; however, for fire detection there are optical smoke detectors installed at the ceiling of this room. There is a fire door (EI30) leading from this room to corridor 22R017. The doors of both rooms 22R075/22R071 are closed (doors have self-closing mechanisms).

Corridor 22R017 contains few cables (fire load due to cabling is 42.4 MJ/m<sup>2</sup>). It also contains power cables, (fire load – 88.2 MJ/m<sup>2</sup>, which gives fire duration less than 10 min. i.e. fire resistance of fire doors and rooms 22R075/22R071 structures is much higher), which are laid above the suspended ceiling. The suspended ceiling structures have fire resistance rating REI90. Cables are the only possible fire sources in the corridor. However all cables have flame retardant coating and in case of fire (e.g. due to short circuit or overload) they will tend to produce smoke, but not an open flame. There are no other materials in the corridor, which could cause rapid fire growth rate.

Corridor 22R017 is equipped with 3 portable carbon dioxide fire extinguishers (5 kg of extinguishing substance each) for manual fire fighting and there are few smoke detectors installed in it. Besides, for manual signalization a manual call point is also installed in the adjacent corridor 22R009.

Behind room 22R075 there is a sub distributor's room 22R007 (Figure 2.2.2-16), where electrical cabinets and cables are located (fire may occur in cabinets or cables; however cables have flame retardant coating). Room 22R007 is an own fire sub-compartment, with fire resistance of the structures EI60, and fire doors EI30. Room 22R007 has a fire load of 438 MJ/ m<sup>2</sup>. Therefore, a rough estimation of fire duration suggests that fire duration could be up to 30 min (i.e. the similar as door fire resistance). Therefore, the fire resistance of room structures is sufficient to limit fire spread to adjacent rooms.

There are optical smoke detectors in the room 22R007 and one CO<sub>2</sub> fire extinguisher (5 kg of extinguishing media) for manual fire fighting.

The amount of cabling and electrical equipment is 10 kg and about similar quantity of electrical cables. Fire analysis of the big electrical cabinets (containing in total about 60 kg of cables, wiring, relays, etc.) showed that heat release rate is ~ 200 kW. Since the heat of combustion of electrical equipment is 16400 kJ/kg, then with one carbon dioxide fire extinguisher (5 kg) located in the room such fire can be extinguished using 53 % efficiency of fire extinguisher.

Another adjacent room is a shaft 22R008 with cables. The shaft is a fire sub-compartment with fire resistance of structures REI90 and fire doors EI60. As fire load in the shaft is 746 MJ/m<sup>2</sup> mainly due to cables, fire duration could be up to 60 minutes. Therefore fire resistance of wall separating rooms 22R008 and 21R071 and fire doors is sufficient to avoid fire spread to adjacent rooms.

The last adjacent room is drum store 21R020 where empty drums are stored. This room is assigned to Eg category according to fire and explosion hazard and therefore does not pose danger to UPS rooms.

So the analysis showed the fire resistance of the UPS rooms is sufficient in order to protect them from possible fires in the adjacent rooms.

### Conclusions

In the most premises of the facility only low quantities of combustible material are located (usually fire loads are much below 300 MJ/m<sup>2</sup>, i.e. fire load category is 3), therefore only negligible fires can occur, which can be controlled by the trained personnel using manual fire extinguishing means, quantity of which is sufficient. Possible fires will be detected by fire detection system, since practically all the premises of the SWTSF are equipped with fire detectors (smoke or flame, which were chosen to be the

## 2. FIRE SAFETY ANALYSES

most suitable for specific location) for fast fire detection and for the sake of the reliability at least 2 detectors are used in one compartment.

Due to properties of surroundings and a provision of fire compartments and sub-compartments, fire dampers in ventilation system, fires will be local, no fire spread to other rooms/structures is expected. The analysis also showed that the resistance of building structures (walls and doors) where safety important and event not safety important equipment is located is sufficient to be able to resist possible fires even without human intervention (i.e. without taking any fire fighting actions).

**Recommendations and safety improvement measures**

After performing FHA for SWTSF some recommendations were proposed (for instance, to prepare accident liquidation plan of the facility and perform functional training including elements of fire fighting and liquidation of radiological accident in the facility; In case of fire to stop all technological processes in the facility and others). Appropriate safety improvement measures were implemented.

**2.2.2.4. Periodic review and management of changes**

The review of fire safety analysis is carried out within the framework of the PSR every ten year. The Final SAR for SWMSF was released in 2022 [5.41]. The PSR for SWMSF shall be performed in 2030. The last Fire Safety Analysis for SWMSF was performed in 2022 [5.42].

The impact of modification on fire safety SSCs important to safety is analysed in planning justifying modification.

**2.2.2.5. Regulator's assessment and conclusions on fire safety analyses**

During VATESI review, it was verified, that the design and layout of the Solid Waste Treatment and Storage Facilities (SWTSF) was prepared taking into account the possible fires hazards in the technological process, which may have a negative impact on the health of personnel/public and the risk of fire to personnel and fire brigades members. During the FHA review of SWTSF conducted by VATESI, it was ensured that the amount of combustible materials in different fire departments was properly assessed, specific fire scenarios were analysed, the duration of possible fires was calculated and the dangers posed by fires were analysed. It was justified that fire resistance of the walls, doors, floor of the building is sufficient to prevent unacceptable fire propagation. Potential sources of ignition have also been identified and it is reasonable to assume that adequate firefighting capabilities will be provided.

The FHA assumed that potential fires would be detected by the fire detection system, since all areas, where is a risk of fire, are equipped with fire detectors (smoke or flame that have been selected as the most suitable for the specific location) and the reliability of fire detection is ensured by having in each compartment at least 2 fire detectors. SE Ignalina NPP has submitted documentation confirming that all recommendations contained in the FHA report have been implemented. VATESI examined these documents, also inspected the SWTSF and, after had satisfied that everything was done issued a permission to operate the SWTSF.

VATESI, following the VATESI inspection program, conducts fire safety inspections at the SWTSF once every three years. During the last inspection, which was carried out by VATESI in 2021, violations and non-conformities with good practice were not identified.

After VATESI review of the SWTSF safety justification documents and taking into account the results of the SWTSF inspections conducted by the VATESI, VATESI concluded that the fire safety analysis of the licensee was performed properly.

### 2.2.3. *Liquid Waste Storage Facilities (Building 151)*

#### 2.2.3.1. Types and scope of the fire safety analyses

The building 151/154 consists of a complex of premises (6 rooms of 1500 m<sup>3</sup> each and 6 rooms of 5000 m<sup>3</sup> each) located next to the connecting corridor. The building has a complex configuration with dimensions of 180.0x80.0 meters (according to the contour). From the east side, building 151/154 connects to building 150 (Figure 2.2.3-1). The connecting corridor is a four-story structure with premises on four levels, part of which is underground from -1.2 meters to +9.60 meters, and the +9.60-meter level above ground.

The foundation of the connecting corridor is made of monolithic reinforced concrete slabs with thicknesses of 1000 mm and 600 mm. The foundations under the columns are also monolithic reinforced concrete. There is drainage and waterproofing beneath the structure.

The frame of the connecting corridor consists of prefabricated concrete columns measuring 400x400 mm with vertical and horizontal metal connections to ensure strength and stability.

The walls of the connecting corridor and stairwells up to the +9.60 m level are made of monolithic reinforced concrete with thicknesses of 400, 500, and 600 mm, while above the +9.60 m level, they are made of 300 mm thick expanded clay concrete panels. The walls of stairwell shafts, control, and measurement rooms are constructed with bricks and are 510 and 380 mm thick. All underground wall sections are waterproofed. Partitions of various thicknesses (140, 100, 120 mm) are assembled from panels, monolithic concrete, or brickwork.

The floor slabs are made of ribbed and hollow prefabricated concrete panels, some of which are monolithic concrete. Stair structures are either prefabricated concrete or metal.

The joints in partitions and gate frames are prefabricated concrete, while the gates themselves, doors, and windows are made of metal and wood with glass block windows.

The roof is flat, made of floor slabs, not ventilated, with internal water drainage, and insulation. The roof is waterproofed with four layers of PKM-350B roofing felt on bituminous mastics. To improve the roof's waterproofing characteristics, it was additionally insulated with a Wolfin membrane.

The complex of buildings 151 and 154 consists of 12 reinforced concrete tanks (Figure 2.2.3-1) internally covered with stainless steel sheets and connected by a common four-story corridor measuring 6x200x16 m (at elevations -1.2 m; +1.8 m; +5.4 m; and +9.6 m), with pumping rooms adjoining them. The complex is located adjacent to building 150. The construction of buildings 151/154 began in 1983, and they were put into operation in 1983. The two tanks located in the western part of building 154 were started to be constructed in 1991 and began operation in 1992. Building 151 contains 6 tanks, each with a volume of 1500 m<sup>3</sup>, and they are intended for collecting sewage water (2 tanks), collecting water from special washers (1 tank) and collecting sediment from ion exchange resin and perlite pulp (2 tanks). The markings of the tanks in building 151 are OTW11B01-OTW11B04, OTW18B01 and OTW18B02. Building 154 contains 6 tanks, each with a volume of 5000 m<sup>3</sup>, and they are intended for collecting chemically desalinated water and evaporated condensate (3 tanks), collecting water from turbine hydro-testing (1 tank), and collecting emergency sewage water (2 tanks). The markings of the tanks in building 154 are OTW13B01, OTW13B02, OTW15B01, OTW15B02, OTW32B01, OTW41B01.

2. FIRE SAFETY ANALYSES

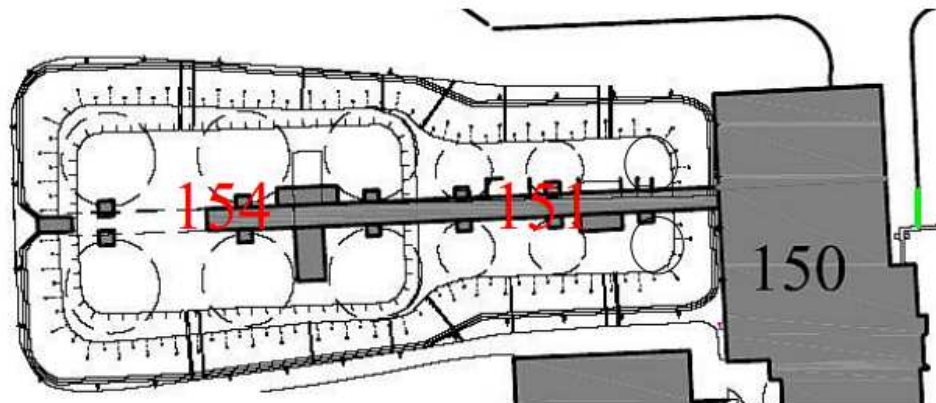
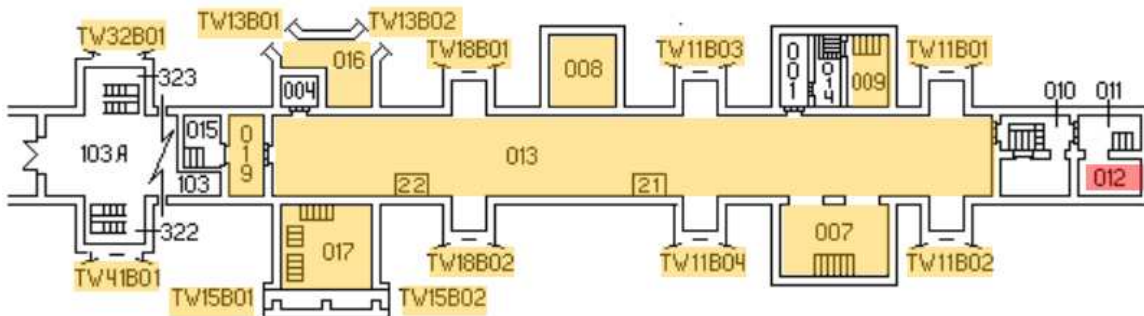

Figure 2.2.3-1. Schematic view from the top of buildings 151/154

From the outside, all the tanks are covered with compacted soil and on top, there is a concrete asphalt surface with a slope for rainwater drainage (i.e., all the tanks are underground). Special reinforced concrete rainwater drainage channels have been installed for rainwater drainage.

All the tanks are underground. The pipelines in buildings 151/154 are in pipe corridors - 013 (-1.20 m level) and 204 (+5.40 m level), and valves and flow meters are usually connected to the pipelines located in those same pipe corridors (Figures 2.2.3-2, 2.2.3-3), and their connections are led to service rooms/corridors.

Pumps are located in rooms 007-009, 016, 017, and 019. All the mentioned pump rooms are adjacent to the pipe corridor at the -1.20 m level. Rooms containing SSCs important for safety are marked in yellow. The rooms marked in red in both images are Cg fire hazard category.



2.2.3-2. The main rooms with safety important SSC at the -1.20 m level.

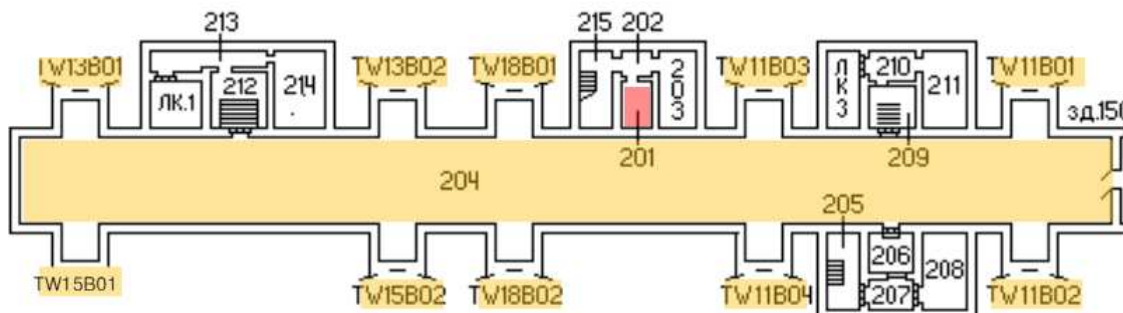

Figure 2.2.3-3. The main rooms with safety important SSC at the +5.40 m level

Figure

## 2. FIRE SAFETY ANALYSES

According to the VATESI document BSR-1.7.1-2014, it is stated that the FHA should justify that the fire safety objectives of the safety significant structures, systems and components are achieved. The main fire safety objectives are as follows:

- Prevent the spread of fires.
- Detect emerging fires.
- Extinguish emerging fires.
- Limit the spread and development of fires.
- Mitigate the consequences of fires for safety important SSCs.

The VATESI document BSR-1.7.1-2014 also emphasizes that NI should ensure the lowest possible probability of internal fires caused by internal events, internal and external hazards, and combinations of these events or hazards as defined in the nuclear energy facility's project. In the event of a fire and subsequent release of smoke, heat due to heat release, chemically active or toxic substances, increased ionizing radiation levels, and the spread of radionuclides due to the fire, the main safety functions defined in the nuclear energy facility's project should be implemented (fulfilled).

### 2.2.3.2. Key assumptions and methodologies

#### Methodology

When performing the analysis of fire parameters, it is necessary to consider not only the fire power but also its duration, flame height, fire-induced temperatures (average, maximum, smoke flow rates, etc.), smoke, its spread, flow rates, visibility, heat release, and other factors. However, relying solely on the evaluation methods makes it not entirely feasible to do so. Therefore, in such cases, numerical methods - computer programs - are used for the assessment of fire dynamics and its parameters. In this work, the FDS5 program will be used, and its suitability, verification, and validation will be described below.

#### The firepower

The firepower, represented as  $Q$  (or in other words, the amount of heat generated during steady combustion), can be calculated using the following formula:

$$Q = m_a * \Delta h_{eff}$$

Where:  $Q$  is the fire power (kW),  $m_a$  is the fuel evaporating from the surface (kg/s),  $\Delta h_{eff}$  is the effective heat of combustion of the fuel (MJ/kg).

Alternatively, when the burning area is known, the fire power  $Q$  can be calculated using the following formula:

$$Q = m * \Delta h_c * A * \chi$$

Where:  $m$  is the fuel evaporating from the surface per unit area ( $\text{kg}/\text{m}^2 \cdot \text{s}$ ),  $\Delta h_c$  is the heat of combustion of the fuel (MJ/kg),  $A$  is the burning area ( $\text{m}^2$ ),  $\chi$  is the combustion efficiency (usually around 0.7-0.8).

#### Gas layer temperature

When conducting an analysis, it is necessary to consider the temperature of hot gas layers generated by the fire and their propagation. Often, various computer programs are used for this assessment. When evaluating gas temperature, the first recommended step is to use computer programs based on zone modeling. These programs can provide sufficient information relatively quickly, but not always. If the room is expected to have high turbulence or if the fire is small compared to the volume of the room, and if temperature differences within the room can be small, then the results obtained by zone modeling may not be very accurate (because in this case, the entire room is divided into only two control volumes). Therefore, it is better to use computer programs based on Computational Fluid Dynamics for such cases.



## 2. FIRE SAFETY ANALYSES

If it is decided that a zone model is insufficient for assessing the consequences of a fire, it is advisable to use a model based on CFD analysis. This is a highly complex model in which the room (space) is divided into numerous small control volumes. Models developed based on CFD are suitable for simulating fires in all types of rooms, and they should be particularly used when:

- The room is large.
- The room geometry is complex.
- Temperature differences between gas layers can be small.
- There may be turbulence within the room.

Initial data for the CFD model include three-dimensional geometric data of the room, fire power, and the data obtained from the model include temperature, its distribution at each location within the three-dimensional space, smoke movement, and more.

As a result, such models are often used in large or complex rooms (or even in structures) to assess smoke temperature and movement in various locations within the room (structure). The main drawback of these programs is that they require significant computer resources, and the fire modeling process takes a long time.

One widely used computer program based on CFD is the Fire Dynamics Simulator. This program is suitable for fire modeling in both simple and nuclear energy facilities. Verification and validation of the FDS program are provided in document NUREG-1824.

FDS has a graphical interface called Pyrosim2012, which is used to input data into the FDS program, set the grid size (i.e., the number of control volumes into which the room/space is divided), and extract results, among other functions.

Like any program based on CFD, the accuracy of the results provided by the FDS program depends on the grid size used. In the case of a coarse grid, the results obtained from the FDS program may be conservative, meaning they are slightly more conservative, while in the case of a finer grid, the results are more precise. It is known that a dense grid is necessary for weaker, smoldering fires. Typically, the optimal grid size depends on the fire power. The characteristic fire diameter  $D^*$  (m) is calculated using the formula provided in NUREG-1824:

$$D^* = \left( \frac{Q}{\rho \cdot c_p \cdot T \cdot \sqrt{g}} \right)^{2/5}$$

Where:  $Q$  is the fire power (kW),  $\rho$  is the air density ( $\text{kg}/\text{m}^3$ , assumed as  $1.2 \text{ kg}/\text{m}^3$ ),  $c_p$  is the specific heat of air ( $\text{kJ}/(\text{kg}\cdot\text{K})$ , assumed as  $1.005 \text{ kJ}/(\text{kg}\cdot\text{K})$ ),  $T$  is the ambient temperature (K, assumed as 293 K),  $g$  is the acceleration due to gravity ( $9.81 \text{ m}/\text{s}^2$ ).

### Temperature of rising hot gas stream

When safety important SSCs, etc., are close to the fire source, it is necessary to determine whether the rising and spreading hot gas stream generated by the fire can affect these SSCs, evacuation routes, etc.

The temperature of the hot gas stream (plume) can be determined by performing calculations manually or with the assistance of computer programs such as zone models or CFD models.

Often, it is necessary to calculate the gas temperature directly above the flame (i.e., the fire source). In this case, it can be done relatively simply (manually) using the formula proposed by Heskestad, assuming that hot gases are heated air due to the fire:

## 2. FIRE SAFETY ANALYSES

$$\Delta T = 25 \left( \frac{Q^{2/5}}{(z - z_0)} \right)^{5/3} \text{ (}^\circ\text{C)},$$

Where:  $\Delta T$  is the difference between gas stream and ambient temperatures,  $z_0$  is the virtual axis of the fire, which depends on the fire diameter and the rate of heat release, and  $z$  is the desired height above the flame.

### Thermal radiation

Heat flux by radiation can be caused by flames, as well as by a hot gas layer. The hot gas layer can radiate to both the component within the gas layer itself and the component farther from the layer.

Thermal radiation from flames affecting safety important SSCs must always be assessed unless it is clearly not a concern.

Radiation from flames can be calculated by treating the flame as a rectangle and using configuration factors. The initial data required for calculations are the flame height, its width, and the distance from the flame to the object. The result obtained is the heat flux affecting the object by radiation (kW/m<sup>2</sup>).

Using configuration factors, the flame is treated as parallel rectangles. When calculating radiation from the center of the rectangle, the flame is divided into four rectangles, each contributing to the total heat flux affecting the object by radiation.

The heat flux by radiation,  $q$ , acting on an object can be calculated as follows:

$$q = \Phi \cdot \sigma \cdot \varepsilon \cdot (T_1^4 - T_2^4),$$

Where:  $\Phi$  is the configuration factor,  $\sigma$  is the Boltzmann constant ( $5.67 \times 10^{-8} \text{ W/m}^2 \cdot \text{K}^4$ ),

$\varepsilon$  is the emissivity,  $T_1$  is the flame temperature (approximately 1200-1500 K),  $T_2$  is the object temperature (approximately 300 K).

The configuration factor can be calculated using this equation:

$$F_{d1-2} = \frac{1}{2\pi} \left\{ \frac{X}{\sqrt{1+X^2}} \tan^{-1} \left[ \frac{Y}{\sqrt{1+X^2}} \right] + \frac{Y}{\sqrt{1+Y^2}} \tan^{-1} \left[ \frac{X}{\sqrt{1+Y^2}} \right] \right\}$$

Where:  $X = L_1/D$ ,  $Y = L_2/D$ ,  $L_1$  is the flame width (meters),  $L_2$  is the flame height (meters),  $D$  is the distance to the object (meters).

When radiation is calculated from the center of the flame, the total configuration factor is calculated as follows:

$$\Phi = 4 \cdot F_{d1-2}.$$

Heat flux by radiation can also be assessed based on computer programs developed using CFD based on the dynamics of such substances.

### Flame height

The average flame height (meters) according to Heskestad can be calculated using the following formula:

$$L = 0,235 \cdot Q^{0,4} - 1,02 \cdot D$$

Where:  $D$  is the diameter of the fire source (m),  $Q$  is the fire (combustion) power (kW).

Flame height can also be determined using computer programs developed based on CFD.

### Visibility

The critical visibility conditions can be calculated based on parameters such as the potential for smoke generation (ob m<sup>3</sup>/m), the quantity of burned material (g), and the volume of the room (m<sup>3</sup>). Optical smoke density can be calculated using the following formula:

$$\frac{D}{L} = \frac{D_0 W}{V} \text{ (dB/m)}$$

Where:  $D_0$  is the material's smoke generation potential (ob·m<sup>3</sup>/g; 1 ob = 1 dB/m),  $W$  is the quantity of burned material (g),  $V$  is the volume of the room (m<sup>3</sup>). Based on the obtained  $D/L$  value from the graph, the visibility (m) can be determined.

Visibility can also be determined using computer programs based on computational fluid dynamics.

### Analysis of fire suppression measures

To determine whether the available portable fire extinguishing equipment (fire extinguishers) can extinguish a fire, a fire suppression equipment analysis needs to be conducted. The evaluation of fire suppression equipment is performed by calculating the required discharge rate of the extinguishing agent and the flow of combustible gases generated during the fire. The required discharge rate of the extinguishing agent is calculated as follows:

$$m_e = m_f \cdot REMP$$

Where:  $m_e$  is the flow rate of the extinguishing agent sprayed from the extinguisher (kg/s),

$m_f$  is the flow rate of flammable gases (kg/s),

$REMP$  is the extinguisher characteristic (i.e., the characteristic of the extinguishing agent; for example, for powder extinguishers,  $REMP = 1.5$ , and for CO<sub>2</sub> extinguishers,  $REMP = 11$ ).

The flow of combustible gases is calculated as follows:

$$m_f = \frac{Q}{H_c}$$

Where:  $Q$  is the fire power (kW),  $H_c$  is the heat of combustion (kJ/kg).

The available extinguishing agent flow rate is calculated as follows:

$$m_a = \frac{m_c}{t}$$

Where:  $m_c$  is the mass of the extinguishing agent (kg),  $t$  is the supply duration of the extinguishing agent (s). Typically, for extinguishers with 6 kg of extinguishing agent, the operation duration is assumed to be 25 seconds. For extinguishers with less than 6 kg, it's about 9 seconds.

If, when comparing both flows ( $m_e$  and  $m_a$ ), it is determined that the extinguishing agent flow rate is greater than the flow rate of burning combustible gases, then it can be concluded that the fire can be extinguished. Otherwise, if the combustible gases' flow rate is greater, it may not be possible to extinguish the fire.

## 2. FIRE SAFETY ANALYSES

When extinguishing with water, the heat absorption capacity of water is compared to the fire's power (i.e., whether the amount of heat generated by the fire can be absorbed by the quantity of water sprayed for fire suppression). It is known that the heat absorption capacity of water droplets is 10.8 MJ/kg. The capacity of hydrants in the Ignalina NPP area is approximately 46 l/s, and in the 150, 151/154 buildings' fire hoses, it's about 4.2 l/s.

Approximately, the theoretical fire extinguishing time ( $t$ , in minutes) when using water, given the fire area ( $A$ , in  $m^2$ ), can be calculated using the formula:

$$t = 1,88 A^{0,52}$$

When extinguishing with foam, the goal is to cover the burning surface with a layer of foam to completely isolate it from the air (oxygen) supply.

**Fire resistance of building structures**

The fire resistance of building structural elements (such as reinforced concrete, brick walls, columns, etc.) is determined by comparing the materials and thicknesses of existing building structural elements, as well as the thickness of the protective layer up to the reinforcement (for reinforced concrete structural elements), with the corresponding structural elements whose fire resistance has been assessed and provided. The minimum thickness of a structural element determines its fire resistance according to the characteristic I (i.e., the ability to maintain insulating properties), and the distance to the reinforcement determines it according to the characteristic R (the ability to withstand loads). After evaluating these parameters, the fire resistance of the structures is presented based on the lower of these parameters (i.e., a more conservative fire resistance value will be provided).

**Smoke filling**

The FDS5 program will be used to assess smoke filling and spread in the rooms.

**Assumptions and Limitations**

During the analysis, the following assumptions and limitations are made:

- Only one fire can occur in one building at a time.
- Lightning is not considered as an ignition source since buildings 151/154 are equipped with and maintained lightning protection systems.
- The presence/combustion of hydrogen is not evaluated because hydrogen concentration measurements with the CBK-3M device did not indicate any hydrogen concentration exceeding the lower explosive limit (i.e., the measured hydrogen concentration is significantly lower than 0.7% by volume, whereas the lower explosive limit for hydrogen in the air is 4% by volume).
- Lighting is not considered as a fire source.
- Only worst-case fire scenarios are analyzed, yielding conservative results.

**Damage thresholds**

Equipment and components can be affected in different ways by a fire. In the literature, the temperature and heat radiation effects (thermal heat flux) are mainly discussed, because these are the only effects that can be evaluated in a quantitative way.

Damage thresholds for typical equipment are given in the Table 2.2.3-1 and for personnel in Table 2.2.3-2.

Table 2.2.3-1. Damage threshold for different equipment

## 2. FIRE SAFETY ANALYSES

Equipment	Critical gas temperature, °C	Critical thermal heat flux, kW/m <sup>2</sup>
Pumps	200-250	8-18
Electrical motors	200-250	8-18
Compressors	200-250	8-18
Electrical equipment	60-70	8-10
Cables	200-250	8-18

Table 2.2.3-2. Damage threshold for personnel

Name	Value	Comment
Critical gas temperature, °C	60	-
Critical gas layer height, m	1.6+0.1H	H – height of the room, m
Thermal heat flux, kW/m <sup>2</sup>	37.5*	100% lethality in 1 min
Thermal heat flux, kW/m <sup>2</sup>	25.0*	100% lethality in 1 min and significant injuries in 10 seconds
Thermal heat flux, kW/m <sup>2</sup>	12.5*	1% lethality in 1 min
Thermal heat flux, kW/m <sup>2</sup>	4.0*	Can stand for short times (10 – 20 min)
Thermal heat flux, kW/m <sup>2</sup>	2.4*	No influence

\* Values for unprotected skin.

Long-time (> 30 min.) tolerable temperature for human is 60 °C, and tolerable heat flux (~30 s.) is 2.5 kW/m<sup>2</sup>.

#### Activation times of fire detectors

The activation times of fire detectors, including temperature and smoke detectors, are crucial parameters for fire safety analysis. Recently, computer programs have been developed to determine the activation times of detectors based on a multitude of experimental test results. One such program is DETACT-T2, which stands for DETector ACTuation – Time squared, and it calculates the activation time of heat devices.

DETECT-T2 is a computer program that can be used to determine the activation time of fixed-temperature fire sensors or sensors that respond to a temperature change over time, based on the user-defined fire growth rate. In this case, the program assumes that the heat released due to the fire follows a quadratic relationship with time, resulting in a more conservative estimate of the activation time (i.e., longer activation time). This is because requires the input of fire power right away, and it does not consider the non-stationary process of fire power buildup.

Moreover, the method can only be used to assess the activation of fixed-temperature sensors, not those that rely on a temperature change over time. Therefore, in this work, the DETACT-T2 program will be used.

DETECT-T2 assumes that the sensor is in a relatively large space and that only the heat flux from the ceiling heats the device, regardless of the heat transfer from hot gases accumulated in the room.

Optical smoke detectors typically have a transmitter emitting ultraviolet or infrared rays and a receiver sensing the light flux. They respond to a fire quite quickly, in the early stage when smoke begins to obstruct the light and reduce light transmission.

Linear optical smoke detectors are also used to detect smoke in the early stage of a fire. These detectors consist of an infrared beam emitter and a receiver. The operation of a linear optical smoke detector is based on checking the air's transparency between the detector and the prismatic reflector.

### 2.2.3.3. Fire phenomena analyses: overview of models, data and consequences. Main results.

The room 007 was selected for the fire analysis as a representative room for the envelope case. There are 3 pumps in this room, and the room is connected to pipe corridor 013. According to the BSR-1.9.3-2016 standard the room is assigned to Category 1 in terms of dose rate, Category 2 in terms of surface contamination with  $\beta$  radiation, and Category 3 in terms of aerosol volume activity.

#### Fire scenario 1. Fire in 007 room

Room 007 is a pump room with dimensions of approximately 11×5.5×5 m. Access to this room is through an airlock. In this room, pipes from the pumps pass through the floor of Room 007 into the pipe corridor 013. To allow the passage of pipes from Room 007 into the corridor 013 (corridor dimensions ~180×5.5×3 m), two rectangular openings, approximately 1.5 m in height and about 4 m in length, have been made in the wall of Room 007.

There are 3 electric motors in Room 007 that drive the pumps. The distances between the motors are not less than 1.2 m. Electrical cables to the motors are brought in metal pipes. When the pumps are not in use, their electrical supply is disconnected.

A computer model of Room 007 with pumps and their electric motors, as well as connecting corridor 013, has been created (only 60 m of corridor 013 are modeled; the entire corridor 013 is not modeled). Pipes (~Ø330×9 mm) from Room 007 go into corridor 013.

In the model, the fire power of the electric motor was assumed to be 100 kW. This is a relatively conservative estimate of the fire power, as, for example, the fire power of large electrical panels (consisting of several tens of relays and switches, 8-10 kg of windings, and 8-10 kg of cables) does not exceed 200 kW. The "main" combustible materials in the electric motor are winding varnish and cable insulation. Such materials, when burning, produce a lot of smoke. In Room 007, one electric motor may contain about 5 kg of such materials.

A fire in an electric motor can occur due to a short circuit, overheating, and similar factors. The duration of the fire, with a constant heat release until all 5 kg are burnt out, will be:

$$t = \frac{\chi \cdot m \cdot \Delta H_c}{Q} = \frac{0,8 \cdot 5 \cdot 16400}{100} = 656 \text{ s}$$

Where:  $\chi$  - combustion efficiency  $m$  - mass of combustible material, kg  $\Delta H_c$  - heat of combustion of electrical equipment (16400 kJ/kg)  $Q$  - fire power, kW

It appears that the fire duration is not very long and does not exceed the fire resistance of the building's structures. The modeling results show that Room 007 becomes filled with smoke in approximately 70 seconds. The smoke, descending to the openings connecting Room 007 and corridor 013, starts to spread and fill corridor 013. In Room 007, the smoke only fills the space between the ceiling and the mentioned openings.

The temperature field shown in Figure 2.2.3-4 indicates that the majority of Room 007 experiences temperatures of 43-55 °C, with higher temperatures directly above the fire source, around 75-100 °C. Since Rooms 007 and 013 are connected with each other, the temperature in Room 007 is not as high, and it spreads into Room 013, reaching only about 27-30 °C (the modeling assumed an ambient temperature of 20 °C). Due to these relatively low temperatures in the connecting openings, pipes, and other equipment in Room 013 are not likely to be damaged.

## 2. FIRE SAFETY ANALYSES

Since the distance between the motors is not less than 1.2 m, the heat flux by radiation from the burning motor to the adjacent motor will also affect it. It was calculated that the heat flux by radiation reaching the neighboring motor from the burning motor is about  $5.4 \text{ kW/m}^2$ . This is less than the threshold for motor damage, so even the nearest motor will not be damaged.

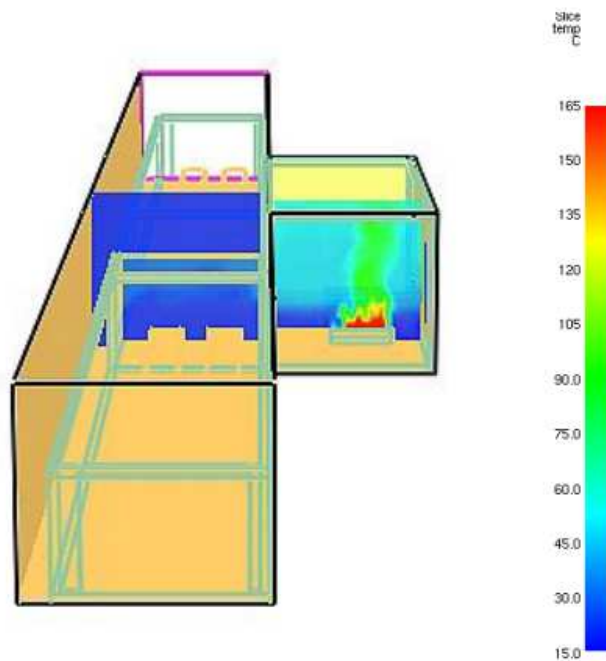

Figure 2.2.3-4. Temperature field in 007 and 013 rooms

The thickness of the pipes connected to the pumps is 9 mm. Assuming it to be a sheet of steel with the same thickness, it has been determined that the fire resistance is approximately 12 minutes. This is slightly longer than the calculated fire duration. However, since there is a fluid inside the pipes, it will help conduct heat better and partially cool the pipe wall. As a result, the pipe will not be damaged due to the temperature caused by the electric motor fire.

#### Fire extinguishment in Room 007

There is no fire detection system in Room 007. The fire can only be detected by personnel inspecting the area based on smoke odor or visually. When any equipment (e.g., pumps) is put into operation in Building 151/154, it is periodically monitored while in use. The building's rooms are inspected twice per shift to observe the equipment's operation, vibrations, leaks, and other factors.

Since the room can quickly fill with smoke due to an electric motor fire, it is not advisable for personnel to enter the room and extinguish the fire without respiratory equipment. Additionally, visibility in the room will be poor. By the time personnel are ready for firefighting, the fire may have already been extinguished or subsided, but the smoke will still be present. Although the temperature in the room may be higher in some areas, it is not critical for personnel in the major part of the room.

Room inspection has revealed the presence of one 5 kg CO<sub>2</sub> fire extinguisher. Assuming a fire extinguishing time of 9 seconds, it has been determined that the quantity of extinguishing agent is sufficient to extinguish the planned fire of the electrical equipment in Room 007, even if the extinguishing efficiency is only 50%.

## 2. FIRE SAFETY ANALYSES

**Smoke**

The primary equipment in Building 151/154 that can catch fire includes electrical equipment such as motors, electrical panels, and the like. It is known that the combustion of electrical equipment (insulation of cables, winding varnish, etc.) produces a significant amount of smoke. The volumes of rooms in Building 151/154 are not very large, except for pipe corridors (013 and 204) and control corridors for equipment (101 and 306). In the event of a fire in those areas where the relatively small-volume rooms in Building 151/154 connect to the pipe corridors, smoke from Building 151/154 will spread through the corridors into Building 150. There are no smoke-sensitive components in the pipe corridors (only pipes with installed dampers, flow meters, and etc. pass through them). Since air is drawn from Building 151/154 through the ventilation systems of Building 150 (creating a reduced pressure in Building 151/154), smoke can spread into Room 230 of Building 150, and it can be expelled through the ventilation stack of Building 150. Room 230 of Building 150 (pipe corridor) is classified as Eg in terms of fire and explosion hazard, and it does not contain combustible materials or smoke-sensitive components, nor does it have a fire detection system. Along with smoke, particulates may be carried by the airflow. These particulates will not affect the pipes, dampers, or flow meters. However, to the extent possible (as access to some areas may be limited due to dose rates, e.g., in pipe corridors), equipment, regardless of its safety class, must be cleaned of particulates and checked for its condition and operation. In other rooms, in the event of a fire, smoke will primarily stay in those rooms, or if doors are open, it will spread to other rooms within Building 151/154. There are no smoke-sensitive elements in the rooms of the building where larger fires may occur (e.g., electric motor fires). In the event of a fire in those two rooms where smoke detectors are installed (017 and 019), they will activate and inform the personnel of the fire. These detectors do not perform any other control system functions.

**Smoke from External Fires**

Smoke can enter Building 151/154 through the supply ventilation systems as they do not have smoke detectors. There is almost no personnel in Building 151/154, and if there is a personnel (e.g., performing system/component maintenance or inspections), smoke can affect them. To reduce the impact of smoke on personnel in Building 151/154, the ventilation system must be manually shut off (there are only smoke detectors in two rooms in Building 151/154, and these smoke detectors do not control any other systems). If smoke somehow enters the rooms with smoke detectors, they may activate and falsely inform personnel of a fire in one or both of the rooms where the detectors are installed. Temporary smoke-filled conditions will hinder personnel's work, but they will not affect the safety of system operation. However, this may temporarily disrupt key technological processes.

**Temperature**

The average temperatures in the rooms due to a fire are not very high because there are not many combustible materials that could burn, and some rooms have relatively large volumes. The temperature can spread from the fire location to other rooms if the rooms are interconnected or if doors are open. Other equipment in the building cannot be damaged due to high temperatures during a fire.

**Fire Extinguishing Agent**

For extinguishing potential fires in Building 151/154, powder or CO<sub>2</sub> extinguishers can be used. When using a powder extinguisher, powder may settle on surfaces in the technical rooms and on adjacent equipment. After the fire is extinguished, all equipment must be inspected, cleaned, and ensured to be operational. When using carbon dioxide extinguishers, the equipment/room where the fire is being extinguished is not contaminated with the extinguishing agent; instead, the gas cools down overheated



## 2. FIRE SAFETY ANALYSES

parts. Additionally, there are two fire hoses in the corridor 306 of Building 151/154. In reality, there is hardly anything to extinguish with water in this room or adjacent rooms. However, there is a drainage system in corridor 306 connected to a specialized drain, and extinguishing water will flow into it and be further managed in Building 150.

**Conclusions**

- The main structural elements of the building are made of non-combustible materials and can withstand the effects of fire for a certain period and limit the spread of fire.
- The weakest structural elements are the floor slabs, with a minimum fire resistance of 45 minutes.
- The majority of the building's rooms are classified as Eg in terms of fire and explosion hazard, with only a few rooms in the Cg category, but they do not pose a significant fire hazard.
- Personnel evacuation is possible, with designated primary and alternative evacuation routes. However, personnel must be familiar with the building and evacuation routes as they are not marked.
- Fire and smoke spread in the building is controlled through fire compartments.
- There are no rooms in the building that pose a significant fire hazard.
- The fire in the building will be local. However, if a fire occurs in the pump rooms, smoke can spread to the 150 building through pipe corridors, as there is no separation between the "contaminated" pipe corridors of the 150 and 151/154 buildings.
- Only two rooms in the 151/154 building have a fire detection system.
- In other rooms, although minor fires may occur, they will not be automatically and quickly detected. Detection will rely on visual or odor-based observations by personnel during room walkdowns.
- There are an adequate number of various types of fire extinguishers (powder and CO<sub>2</sub>) in the building for fire extinguishment. If necessary, extinguishers in Building 150 can also be used.
- The analysis of a fire in one of the typical building rooms (pump room 007), determined that an electric motor fire can last approximately 11 minutes. However, after about 70 seconds, the room is filled with smoke, which, descending to the vents connecting room 007 and corridor 013, starts spreading and filling corridor 013 (room 007 fills with smoke only from the top to the mentioned vents).
- Higher temperatures in case of a fire in Pump Room (007) are only localized at the fire source. However, due to the room's large volume and its connection to Corridor 013, high temperatures are not accessible within the room. As a result, adjacent equipment and pipelines cannot be damaged.
- Since there is no fire detection system in the room, a fire can start and end without being detected. It can only be detected by personnel inspecting the rooms based on smoke odor or visual cues. Building inspection is carried out by the on-duty staff once per shift, three times a day.
- When extinguishing fires with water, water will be confined by the building's structures, and after the fire, it will flow or be pumped into a specialized drainage/sewer system in the building.
- Firefighting in this building, especially in the pump rooms, is unique in that the dose rates in those rooms are relatively high. Therefore, before engaging in firefighting, it is crucial for personnel or firefighters to assess the radiological situation in the room and control their time in the fire zone.

**2.2.3.4. Periodic review and management of changes**

The review of fire safety analysis is carried out within the framework of the PSR every ten year. The last PSR for building 151 was performed in 2018 [5.43].

The last Fire Safety Analysis for SNFSF-1 was performed in 2020 [5.44].

The impact of modification on fire safety SSCs important to safety is analysed in planning justifying modification.

#### **2.2.3.5. Regulator's assessment and conclusions on fire safety analyses**

VATESI reviewed Liquid Waste Storage Facilities (building 151)(LWSF) the periodical safety review report "Periodic safety assessment report of the liquid radioactive waste cementation complex, buildings 150, 151/154, 158/2", which was submitted in 2018 and did not found detailed FHA for LWSF. Therefore, it was required to perform FHA and submit it to VATESI. The licensee prepared and submitted LWSF FHA to VATESI in 2020. VATESI reviewed this report and submitted questions to it. The licensee provided additional information and VATESI evaluated it. During the review, conducted by VATESI, it was confirmed that the summary conclusions presented by FHA are acceptable: in building LWSF fire propagation and spread is not possible due to the characteristics of its structural materials; limiting the spread of fire/smoke in the building is ensured as a result of the adequate fire compartments and subdivisions; the spread of fire through cables is limited due to their proper coating with paste; the building has a fire detection system, which is periodically tested, which allows timely detection and elimination of faults and ensures the system's operability; the building has a low fire load and; the amount of primary portable fire extinguishing agents (extinguishers) of various types (powder, CO<sub>2</sub>) is sufficient; the safe work of fire-rescue service workers is ensured because the maintenance of the territory is properly carried out, ensuring sufficient distances that allow firefighters-rescuers to approach all the necessary places of the building; LWSF employees are ready to meet and accompany members of the fire-rescue service to a possible fire location. The FHA report provided recommendations for improving the fire safety of LWSF and all appropriate safety improvement measures were implemented.

VATESI carried out an inspection at the LWSF in 2022 to check fire safety at the LWSF, any violations and non-conformities with good practice were not identified. The frequency of fire safety inspections of LWSF are determined in the VATESI inspection program (once every 4 years).

VATESI reviewed the SARs of the LWSF submitted by SE Ignalina NPP and concluded that the fire safety analyses were adequate.

#### **2.2.4. Bituminized Waste Storage Facility (Building 158)**

##### **2.2.4.1. Types and scope of the fire safety analyses/**

The bituminized radioactive waste storage facility (Building 158) belongs to the surface type and is a prefabricated monolithic reinforced concrete structure connected to buildings 150 on the east side and 158/2 on the west side by pedestrian-technological galleries. Building 158 is divided into 12 compartments by internal partitions, including 11 compartments with a volume of 2500 m<sup>3</sup> each and one compartment with a volume of 1000 m<sup>3</sup>. The total internal (geometric) volume of the 12 compartments is 28500 m<sup>3</sup>, and the working volume for filling the 12 compartments is 22800 m<sup>3</sup> (80% of the geometric volume). The inner surface of compartments No.1 (UF44B01) and No.2 (UF44B02) is covered with a layer of "cement-silicate mixture" with a thickness of 10 mm. The inner surface of the walls and columns of compartments No.3 (UF44B03), No.4 (UF44B04), No.5 (UF45B01), No.6 (UF45B02), No.12 (UF59B01), No.11 (UF59B02), and No.10 (UF59B03) is lined with 4 mm thick carbon steel up to a height of 4.5 meters and 3 mm thick stainless steel from 4.5 to 5.5 meters. The bottom of each compartment is covered with a layer of cement mortar with a thickness of 50 mm, and the surface of the cement mortar is covered with a waterproofing layer of rubber-bitumen mastic with a thickness ranging from 5 to 50 mm. Additionally, the bottom of compartments No.11 (UF59B02) and

## 2. FIRE SAFETY ANALYSES

No.10 (UF59B03) is lined with carbon steel 4 mm thick from the inside. On top of the structure, there is a two-story superstructure housing rooms for technological pipelines and equipment maintenance.



Figure 2.2.4-1. Partial view of the Bituminized Radioactive Waste Storage Facility

The construction of building 158 began in 1981 and it was put into operation in 1987. The plan, labeling, and arrangement of the compartments of the Bituminized Radioactive Waste Storage Facility are shown in Figure 2.2.4-2. Compartments No. 1÷6, 10, and 12 loaded with radioactive waste are marked in brown. Compartments No. 7, 8, and 9 are empty and will not be filled, marked impairment No.11 (UF59B02) is partially filled. UF44B01 – is a compartment labeling, No.1÷12 are compartment numbers. At present, the filling of the storage compartments has been discontinued.

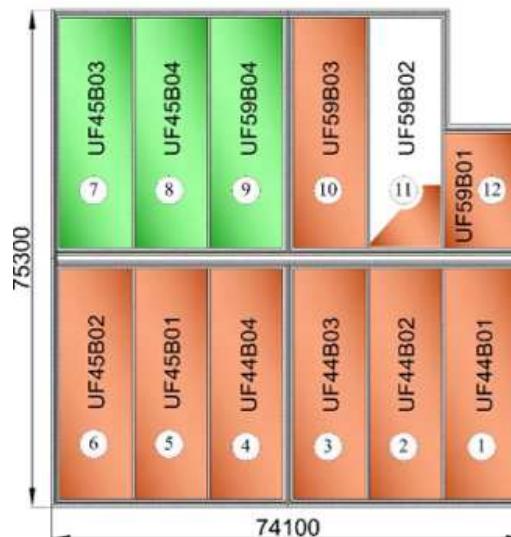

Figure 2.2.4-2. Plan of the layout of compartments (canyons) of building 158 with their labeling and numerical numbering.

According to the VATESI document BSR-1.7.1-2014, it is stated that the FHA should justify that the safety objectives of the safety important SSCs fire are achieved. The main fire safety objectives are as follows:

- Prevent the spread of fires.

## 2. FIRE SAFETY ANALYSES

- Detect emerging fires.
- Extinguish emerging fires.
- Limit the spread and development of fires.
- Mitigate the consequences of fires for SSCs important to safety.

The VATESI document BSR-1.7.1-2014 also emphasizes that NI should ensure the lowest possible probability of internal fires caused by internal events, internal and external hazards, and combinations of these events or hazards as defined in the project of the NI. In the event of a fire and subsequent release of smoke, heat due to heat release, chemically active or toxic substances, increased ionizing radiation levels, and the spread of radionuclides due to the fire, the main safety functions defined in the NI's project should be implemented (fulfilled).

#### 2.2.4.2. Key assumptions and methodologies

The key assumptions and methodologies is similar to that specified in Section 2.2.3.2 of this NAR.

#### 2.2.4.3. Fire phenomena analyses: overview of models, data and consequences. Main results.

##### Fire in Technological Ducts

Inspection of the compound supply technological ducts revealed that these ducts, through which the compound supply pipes are routed, are constructed from non-combustible materials - reinforced concrete blocks, which are not covered with any materials (not even paint). Therefore, if a fire were to occur there, its spread through such structures is not possible. There are also no materials/equipment in the compound supply technological ducts, no potential sources of ignition that could pose a fire hazard, i.e., they only contain the compound supply pipe, which is covered with non-combustible thermal insulation (rock wool, enclosed in stainless steel sheeting), fire extinguishing foam nozzles, and fire alarm sensors. In the event of a fire in the technological ducts (e.g., during compound supply), personnel are responsible for extinguishing it before the arrival of firefighters, as specified in the IAE instructions.

##### Fire in the Communication Corridor

The compound supply communication corridors are quite long, approximately 70 meters in length, and their height is about 2 meters. There are a total of three communication corridors. The width of the side corridors is around 1.7 meters, while the central corridor, where the compound supply pipes are installed, is about 2.5 meters wide. However, this central part of the corridor is divided into three separate sections, each with a width of approximately 70 cm. These three sections are separated from each other by reinforced concrete blocks with a thickness of 200 mm. The central corridor sections cannot be completely sealed from each other because there are openings in them (located at approximately 1.1-1.2 meters above the floor). These openings are slightly larger than the diameter of the compound supply pipe with thermal insulation through which the compound supply pipes were previously routed through communication channels and canyons. Currently, there are no compound supply pipes running from the communication corridor to the communication channels; they have all been dismantled, except for the pipe leading to Channel/Canyon No. 11 (as compound is currently being prepared to fill this last canyon).

Since compound will be filled in Canyon No. 11, it is most likely that accidents/fires may occur in this canyon area. Therefore, in this scenario, the fire is analyzed in the technological channels of this canyon, specifically in the communication corridor.

During the building inspection, it was determined that the angle in the communication corridor wall through which the compound supply pipe passes into the communication channel (i.e., Channel No. 11) is completely sealed with stainless steel sheeting.

## 2. FIRE SAFETY ANALYSES

During the compound supply to the canyon, the compound supply pipe is heated only by steam (no fire-hazardous materials or devices are used for heating), which is supplied from the steam boiler room. The temperature of the steam supplied from the boiler room does not exceed 170°C (i.e., about 70°C lower than the compound flash temperature and the maximum temperature of the compound transported to Building 158 is about 125°C). The compound supply pipe is not continuous; it is only of a certain length and is connected by flanges. During the compound supply to the canyons, it is possible that due to the vibration of the pipes, the bolts of the flanges may become loose, and compound may start to flow through the flanged connection onto the floor of the communication corridor.

During the compound supply to the canyon, several compound pressure sensors are installed on the compound supply pipe. The readings of three sensors are output to a panel located in Room 711, which is manned 24/7. The readings of other sensors are local. Out of the three pressure sensors, whose readings are output to the panel, two are in the bitumen room, and one is on the compound supply pipe in Building 158.

If there is a rupture in the compound supply pipe or if the flanged connection becomes unsealed, the pressure in the compound supply pipe will start to decrease (the pipe will be hermetically sealed), and the pressure sensors will begin to signal this to the operators in Room 711. In such a case, the personnel will go to investigate the cause of the pressure drop. Conservatively estimating, the lack of compound supply pipe tightness can be detected fairly quickly - within 5-10 minutes, and depending on the type of cause, the compound supply can be stopped immediately.

**Fire Power and Burning Duration Determination**

The maximum capacity of the compound supply pump is 300 kg/h, but as specified by the IAE, the actual maintained compound supply rate is only about 120 kg/h. In a conservative calculation, it was assumed that Ignalina NPP personnel may take about 15 minutes to locate the damaged pipe sealing and that the compound supply rate is 150 kg/h. In such a case, it was estimated that approximately 40 kilograms of compound could leak.

There are no fire hazards or potential ignition sources in the technological channels of Building 158 that could ignite the leaked compound. However, for example, the behavior of personnel with fire can be considered as a fire/ignition source (e.g., the decision to use a flashlight during inspection, smoking, etc., although this is strictly prohibited, personnel are informed about it during fire safety training; in reality, to ignite the compound (bitumen), a flame source would have to be applied to the surface for some time, and the compound would have to be waited for it to ignite). Fire spread in the technological channels is only possible through the surface of the spilled compound, and in such a case, the duration of the fire depends greatly on the area of the spilled and ignited compound.

Therefore, in this scenario, a hypothetical fire is further analyzed, aiming to determine what would happen if the spilled compound were ignited.

As mentioned, the compound (bitumen) delivered to the canyon is approximately at a temperature of 125°C. The viscosity of compound (bitumen) at this temperature is about 6.8 times higher than that of water. Approximately, the area occupied by the spilled liquid can be calculated using the formula:

$$\log(A) = 0.492 \log(m) + 1.617,$$

where  $A$  is the area occupied by the spilled liquid in square feet, and  $m$  is the total weight of the spilled liquid in pounds. When calculating the area for a non-water liquid using this formula, it is necessary to take into account the ratio of viscosities between water and the liquid being calculated.

The density of compound (bitumen) at 125°C is about 1200 kg/m<sup>3</sup>.

1 square foot = 0.0929 m<sup>2</sup>.

## 2. FIRE SAFETY ANALYSES

1 pound = 0.454 kg.

It was determined that the mass of the spilled compound (taking into account the ratio of viscosities between water and bitumen) would occupy about 5.4 m<sup>2</sup>. Since the width of the communication corridor is 0.7 meters, the length of the spilled compound (bitumen) in the corridor will be approximately 7.7 meters, and accordingly, the average thickness of the compound (bitumen) layer is almost about 1 cm. (Of course, in a real scenario, there may be some spreading of the compound on the walls and floor of the technological corridor/canyon due to a lower layer thickness (and a larger area), resulting in a shorter fire duration.)

The power of the ignited compound (bitumen) will be equal to:

$$0.045 \text{ kg}/(\text{m}^2 \text{ s}) \cdot 5.4 \text{ m}^2 \cdot 40.95 \text{ MJ/kg} \cdot 0.8 = 8000 \text{ kW}.$$

In the case of steady burning, the fire duration will be  $40/(0.045 \cdot 5.4 \text{ m}^2) = \sim 165 \text{ s}$  (about 3 minutes). Thus, by the time the firefighters arrive (arrival time is about 20 minutes), such a hypothetical fire would have already extinguished.

### Temperature Assessment

The FDS program was used to create a computer model of the communication channels. A total of two models were tested, with grid element counts of  $3 \cdot 10^6$  and  $2.5 \cdot 10^6$ . Maximum temperatures obtained in both cases were compared. It was confirmed that in both grid cases, the maximum temperatures obtained were the same (see Figure 33). However, a more detailed analysis showed that in the case of a sparser grid, higher temperatures spread further from the fire source. In contrast, in the case of a denser grid, the dissipation of temperatures is lower, and higher temperatures are concentrated more only in a certain area around the fire source, without significant temperature increases in other zones (see Figure 2.2.4-3).

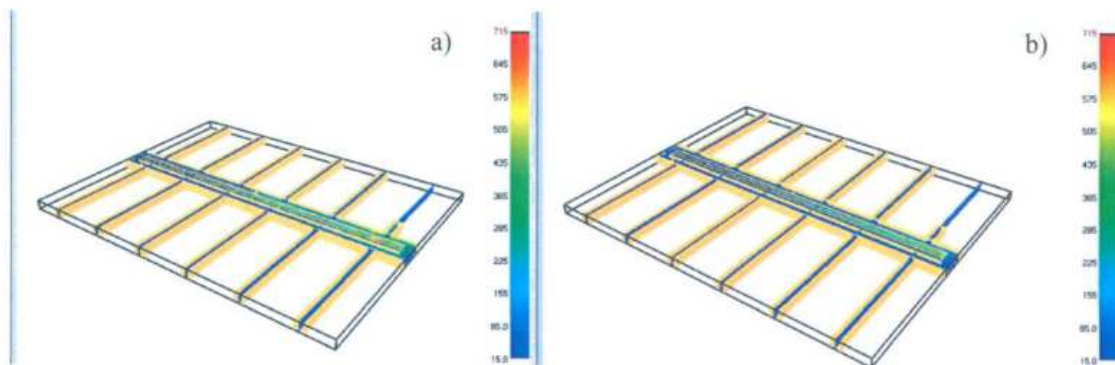

Figure 2.2.4-3. Comparison of Temperatures in Different Grid Cases: a - Sparse Grid, b - Dense Grid

To obtain a more conservative result, all subsequent simulations were performed using a sparser grid. Additionally, results of simulations with a sparser grid are slightly elevated (hence more conservative).

In the computer model, it was assumed that the ignition of spilled bitumen occurs in the communication corridor where the compound supply pipe from the second bitumen unit is located, as shown in Figure 2.2.4-5. The model was used to analyze the distribution of temperature (Figure 2.2.4-4) and smoke spread (Figure 2.2.4-5) in the technological channels. During modeling, it was also assumed that the forced ventilation system of the technological channels is not operational (i.e., heat/smoke during the fire can only be naturally removed into the environment, not through forced ventilation).

The highest temperatures are reached in the fire zone and in the part of the communication corridor where the fire occurred. Detailed temperature distribution in the communication corridors adjacent to

## 2. FIRE SAFETY ANALYSES

the entrances to the communication canals (Figure 2.2.4-4, a) analysis showed that the highest temperatures are in the corridors located in the northern part of the building on the mezzanine (-1/3 of the corridor height from the ceiling). The dominant temperature range is 65-110°C on average, while in the area where the fire occurred, it is 290-470°C. In the lower part of the corridors (2/3 of the corridor height from the floor), temperatures are not very high (30-65°C).

In the corridors located in the southern part of the building, temperatures are lower - on average, near Canyons No. 3+6, temperatures range from 35-55°C, and near Canyons No. 1+2, temperatures range from 55-110°C. These temperatures are in the upper part of the corridors (-1/3 of the corridor height from the ceiling), and in the lower part, temperatures are significantly lower (25-55°C range).

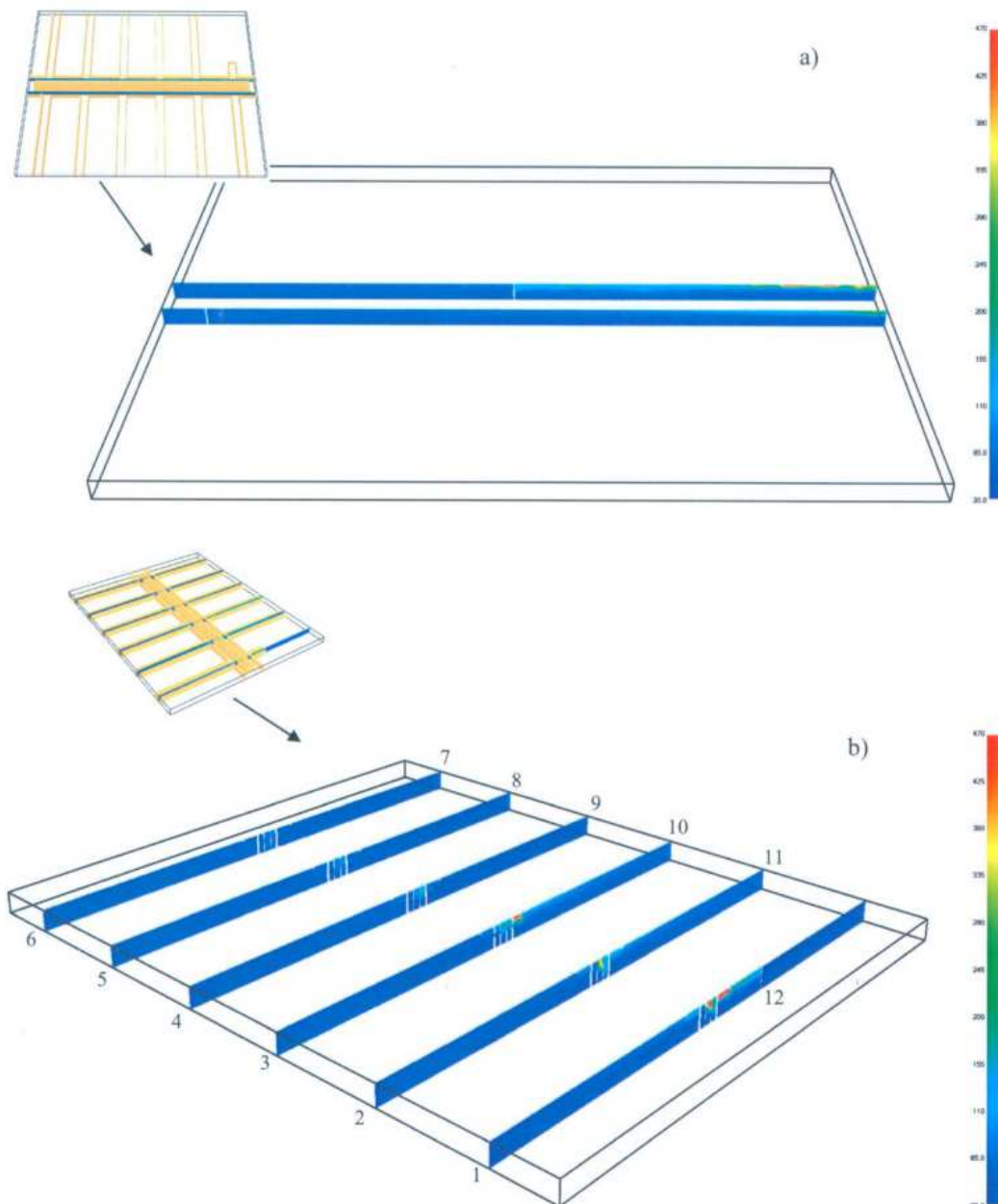

Figure 2.2.4-4. Temperature Distribution in the Technological Channels of Building 158 at the End of the Design Fire: a - in communication corridors adjacent to the entrances to the communication canals, b - in communication canals

Since the corridors are not completely separated from the communication canals, in the event of a fire, the temperature will spread into the communication canals. However, there is no significant increase in temperature in the canals, except for canals No. 10-12, where a fire has occurred in Canal No. 12 on the deck. Since this canal has a canyon ventilation system, this temperature does not fill the entire volume of the canal, and all heat (temperature) is dissipated into the environment through the ventilation chimney (similar to communication canal No. 1). In the lower part of this canyon, the temperature is in the range of 30-85°C. Canals No. 10 and 11 have temperatures ranging from 38-80 °C (slightly higher - 140-180°C temperatures are at the beginning of these canals on the deck).

These temperatures are too low to damage the metal inserts of the canyon openings, and they will have no effect on the concrete structure of the building. This temperature will also have no effect on the compound stored in the canyons.

#### Evaluation of Fire Detector Response Time

Since fixed-temperature fire detectors IT-104 (or iT-105) are installed in the technological channels, which trigger at a temperature of 70 °C, taking into account their distribution (every 5.7 m in communication corridors), installation height, and assuming that the fire development rate is fast (since the spilled compound will be warm, it will be easier to ignite), and the ambient temperature in the technological channels is 20 °C, the response time of the fire detectors was estimated to be approximately 2.06 minutes (123 s).

Fire detectors located in communication corridors are not duplicated, but in separate corridors, they are connected to separate fire detection system zones. As shown by the temperature distribution results in the channels, in adjacent corridors (in the zone near the fire source), the temperature will reach a value at which the detectors will also activate. However, in this case, the response time will be longer, and such activation will already be partially false because it will not be clear where exactly the fire has occurred - in the channel or the corridor. Therefore, it is necessary to maintain all detectors in excellent working condition to ensure their flawless operation.

#### Assessment of Smoke Generation, Spread, and Visibility in Smoke

It was calculated how quickly one communication corridor (despite the openings in it), for example, to half of its volume (the dimensions of the entire corridor are 0.7x70x2 m, and the volume is 98 m<sup>3</sup>), would be filled with smoke:

$$\tau = t \sqrt{\frac{9,81}{2} \cdot \frac{2^2}{70 \cdot 0,7}} = 0,18t.$$

$$Q^* = \frac{8000}{1100 \cdot 2^{5/2}} = 1,28.$$

$$(Q^*)^{1/3} \tau = 4,6, \text{ iš čia } \tau = 4,6 / 1,28^{1/3} = 4,2.$$

The time it takes for the smoke layer, under constant combustion, to fill half of the corridor's height (or half of its volume - 49 m<sup>3</sup>) is equal to:

$$0,18 \cdot t = 4,2, \text{ t. y. } t \approx 23 \text{ sek.}$$



## 2. FIRE SAFETY ANALYSES

Thus, half of one corridor's volume (49 m<sup>3</sup>) will be filled with smoke in 23 seconds (and the entire volume in about 46 seconds), which means the average rate of smoke generation is  $49/23 = 2.1$  m<sup>3</sup>/s.

Because the technological channels are not completely isolated from each other, smoke will spread to other communication canals and corridors. Throughout the design fire duration, approximately  $200 * 2.1 = 420$  m<sup>3</sup> of smoke will be generated. The total volume of all communication canals is about 1500 m<sup>3</sup>, but the canals leading to canyons No. 7, 8, and 9 are isolated, and smoke entry there will be significantly restricted. Therefore, the remaining volume of communication canals (1500-350) -1250 m<sup>3</sup>, ideally, if the smoke were only confined to the deck, would be filled with smoke on average by about 1/3. However, smoke will not distribute perfectly evenly. Most of the smoke will be in the zone near the fire source, and in the further zones, there will be less smoke.

Since the forced ventilation system in the technological channels (consisting of two fans) has a capacity of 3040 m<sup>3</sup>/h = 0.85 m<sup>3</sup>/s, only when both fans are operational, approximately  $(0.85/2.1)$  40% of the smoke volume generated during the fire can be exhausted outside. With this ventilation system in operation, the "smoke generation rate" would still be around  $(2.1-0.85) \sim 1.25$  m<sup>3</sup>/s.

Smoke generation, of course, affects visibility. Visibility, when burning the entire mass of compound (40 kg) assuming a combustion efficiency of 0.8, would be:

$$\frac{D}{L} = \frac{D_0 W}{V} = \frac{1.8 \cdot 40000 \cdot 0.8}{1250} = 46$$

here,  $D_0$  represents the smoke generation potential of the material, but for bitumen, it is unknown (not found in the literature). Therefore, the smoke generation potential for this case was assumed to be similar to that of PVC (which also generates a lot of smoke), which is 1.8 m<sup>2</sup>/m.

So, if smoke in the technological channels is evenly distributed (an idealized case), visibility in the technological channels when all the spilled bitumen is burned would be very poor, possibly as low as 0.3 m or even less.

The FDS program analyzed the distribution of smoke in the technological channels (Figure 2.2.4-5). It was also assumed in the model that the metal plates separating the entrances to canyons No. 7, 8, and 9 are not perfectly sealed. To obtain a more conservative result, it was assumed that smoke would escape into the environment not by forced means (i.e., it was assumed that the ventilation system fans were not operational), but only by natural means through the ventilation system chimneys of the technological channel.

## 2. FIRE SAFETY ANALYSES

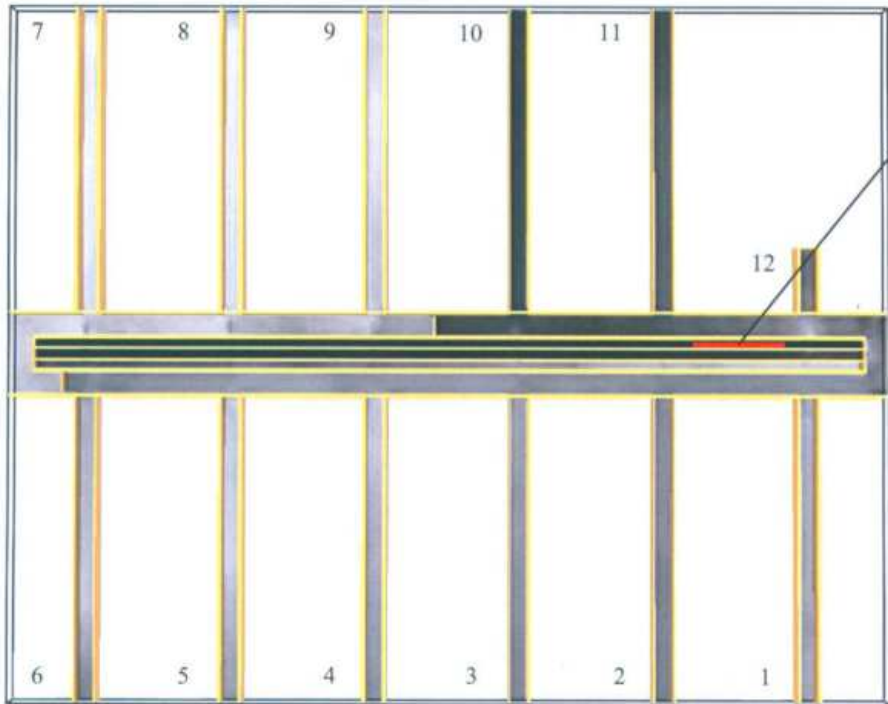

Figure 2.2.4-5. Smoke distribution in the technological channels of Building 158 at the end of the design fire

Modeling showed that all the communication channels and corridors will be completely filled with smoke. The thinnest smoke layer will be in separate channels - channels No. 7-5-9. The densest smoke (indicated in black in Figure 2.2.4-5) will be in communication channels No. 10-12 and in the communication corridors adjacent to these channels.

The smoke itself will not affect the building, the compound storage, or the SSCs functions important to safety. During a fire, fire system sensors and dry pipes/sprinklers may be covered in soot. Therefore, after the fire, all these systems should be cleaned and inspected.

### Firefighting Possibilities

There are no manual firefighting tools in Building 158. Therefore, for initial firefighting, the staff will use portable firefighting tools located in Building 150.

As the analysis has shown, a significant amount of smoke will be generated during the design fire, which will hinder visibility/breathing for the firefighting personnel. Additionally, high temperatures will prevail near the fire source. It is essential to remember that radioactive material is involved. Therefore, the personnel should assess the radiological conditions before approaching the fire (during or after the fire, inspecting the fire area, etc.).

The personnel should be properly dressed and equipped, using available breathing apparatus with full-face masks.

Firefighting should be carried out by spraying the extinguishing agent into the fire source. Since there are technical openings in the walls of the communication corridors, the extinguishing agent can be sprayed through them into the fire source. In this case, the walls themselves would act as a shield, protecting personnel from radiant heat.

## 2. FIRE SAFETY ANALYSES

Powder extinguishers are generally effective for combating fires, and they are widely available. An evaluation was conducted to determine if a 6 kg powder extinguisher could extinguish the design fire involving spilled and ignited compound. The flow of flammable gases will be:

$$m_f = \frac{8000}{40950} = 0,195$$

Required extinguishing agent flow:

$$m_e = 0,195 \cdot 1,5 = 0,293.$$

available extinguishing agent flow (flow from the extinguisher):

$$m_a = \frac{6}{25} = 0,24 .$$

It can be seen that the required extinguishing agent flow is greater ( $m_e > m_a$ ) than the available extinguishing agent flow, so it will not be possible to extinguish the project compound fire with such an extinguisher. However, it should also be noted that it is impossible to use the extinguisher 100 % effectively. Assuming that the extinguisher is used effectively only 50 % (i.e., only 50 % of the extinguishing agent is sprayed effectively - directly into the fire source), it was found that at least three powder extinguishers are needed for successful extinguishing of such a fire (bitumen or compound fire can also be extinguished using CO<sub>2</sub> extinguishers; the analysis also showed that using CO<sub>2</sub> extinguishers for such a fire would require about 9 extinguishers assuming an efficiency of 100 %).

To avoid personnel carrying extinguishers for fire extinguishing from 150 or 158/2 buildings, it is recommended to install three powder extinguishers (each containing 6 kg of extinguishing agent) in room 120 of Building 158.

### Fire in the Communication Channel

In this case, the same release and ignition of the compound were analyzed, but it was assumed that the release occurs in the communication channel. For the same reasons, channel No. 11 was also chosen in this scenario.

In this case, all the assumptions from the previous fire scenario apply (area of release, possible sources of ignition, smoke generation rate, visibility, etc.). The FDS program was used to analyze the temperature and smoke distribution, as well as to evaluate the response time of fire detectors and the possibility of compound (or ignited compound) entering the canyon.

It should be mentioned that in the place where the communication channels "connect" with the communication corridors, there are concrete thresholds about 10 cm high. With their help, the spilled compound will be retained and will not flow into other communication channels, so the spread of fire will be prevented. The fire can only spread along the surface of the spilled compound.

### Temperature Assessment

The temperature distribution in the communication channels (Figure 2.2.4-6, a) showed that the highest temperature is reached in the channel where the fire occurred (in this case, channel No. 11; the location of the fire is shown in Figure 2.2.4-7), right above the fire source, and only in the balcony of the channel (820°C). It was found that further from the fire source in this channel, an average temperature of 120-190 °C prevails. These are high temperatures, but lower than the ignition temperature of the compound.

A detailed analysis showed that high temperatures are also present in channels No. 10 and 12. In channel No. 12, a higher volume part of it is dominated by a temperature of 50-110°C, which does not rise higher (because the heat is dissipated through the ventilation chimney), and in channel No. 10, a slightly higher

## 2. FIRE SAFETY ANALYSES

temperature is present 170 °C at its beginning, and the rest of the channel has temperatures of only 70-90 °C. In other channels, very high temperatures are not reached (e.g., in channels No. 6+2, the temperature is in the range of 25-40 °C, and in channel No. 1, it is in the range of 30-50 °C; a slightly higher temperature of approximately 160 °C is only in the upper part of channel No. 1 and only at the beginning of the channel (Figure 2.2.4-6, a) up to the location of the ventilation chimney, through which the heat is dissipated outdoors, and the rest of the channel volume does not heat up).

The highest temperature is reached in the communication corridor located next to the entrances to communication channels No. 10+12 (Figure 2.2.4-6, b). Right next to the fire zone, in the balcony of the corridor, temperatures of 220-600 °C prevail, while in other parts of this corridor, temperatures are in the range of -65-140 °C. The temperature also spreads to the communication corridor located next to the entrances to communication channels No. 1-6. However, the highest temperature (90-180 °C) is only in the eastern part of this corridor, near the ceiling level.

In summary, the analysis of temperature evaluation shows that due to high temperatures, it will be very difficult for personnel to reach the fire area and start extinguishing the fire on their own, and before that, the radiological situation should be assessed. However, even in this case, the temperature will not affect the execution of functions related to SSCs safety.

## 2. FIRE SAFETY ANALYSES

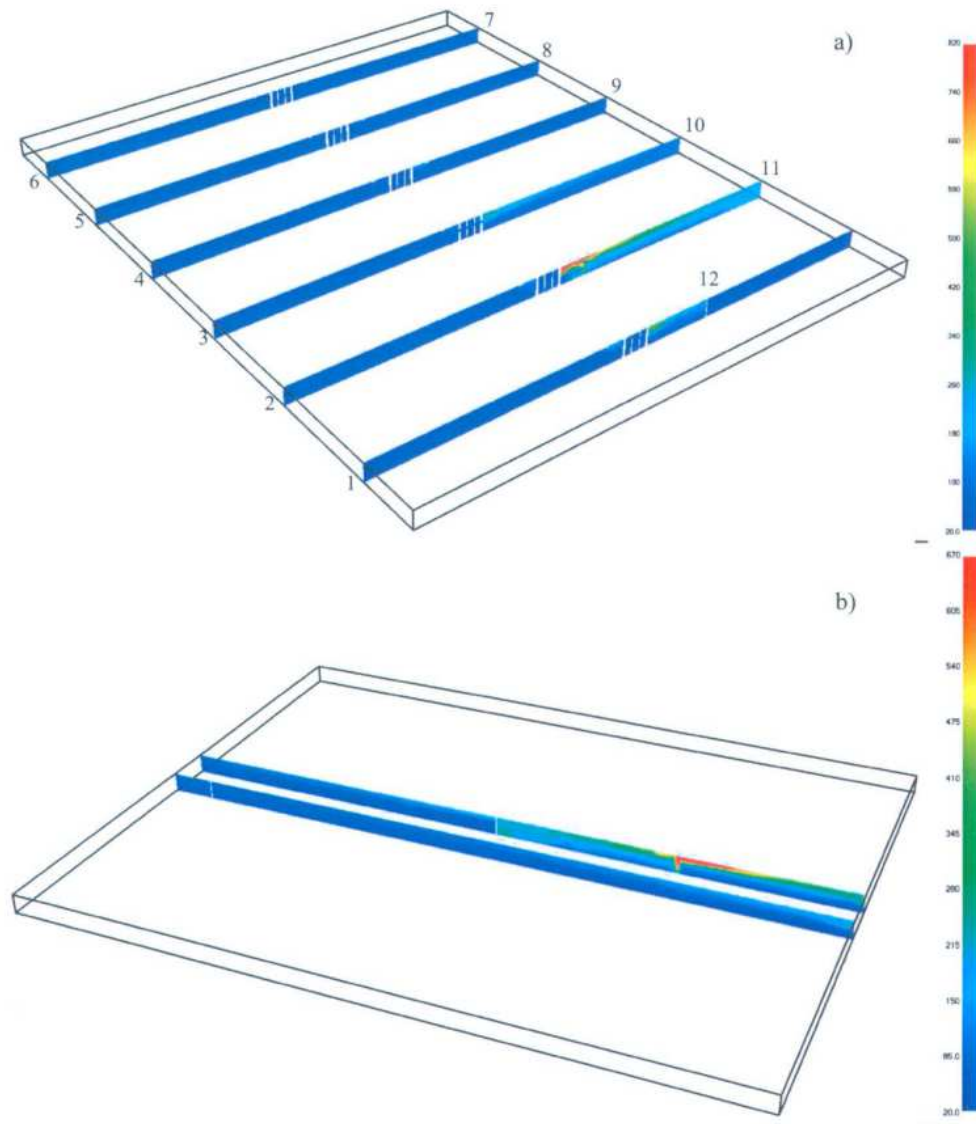

Figure 2.2.4-6. Temperature distribution in the technical channels of Building 158 at the end of a design fire: a - in the communication channels, b - in the communication corridors adjacent to the entrances to the communication channels.

Smoke Spread Assessment As indicated by the modeling results (Figure 2.2.4-7), initially, smoke fills the channel where the fire occurred (in this case, Channel No. 11). Afterward, smoke begins to spread into the adjacent communication corridor, and from there, it gradually fills the neighboring communication channels (in this case, No. 10 and 12). Smoke continues to spread into the southern part of the building's communication corridor, gradually filling it along with communication channels No. 1-3. After some time, the smoke continues to spread, filling up communication channels No. 4-6. However, it's worth noting that even after the end of the design fire, communication channels No. 5 and 6 are not completely filled with smoke.

## 2. FIRE SAFETY ANALYSES

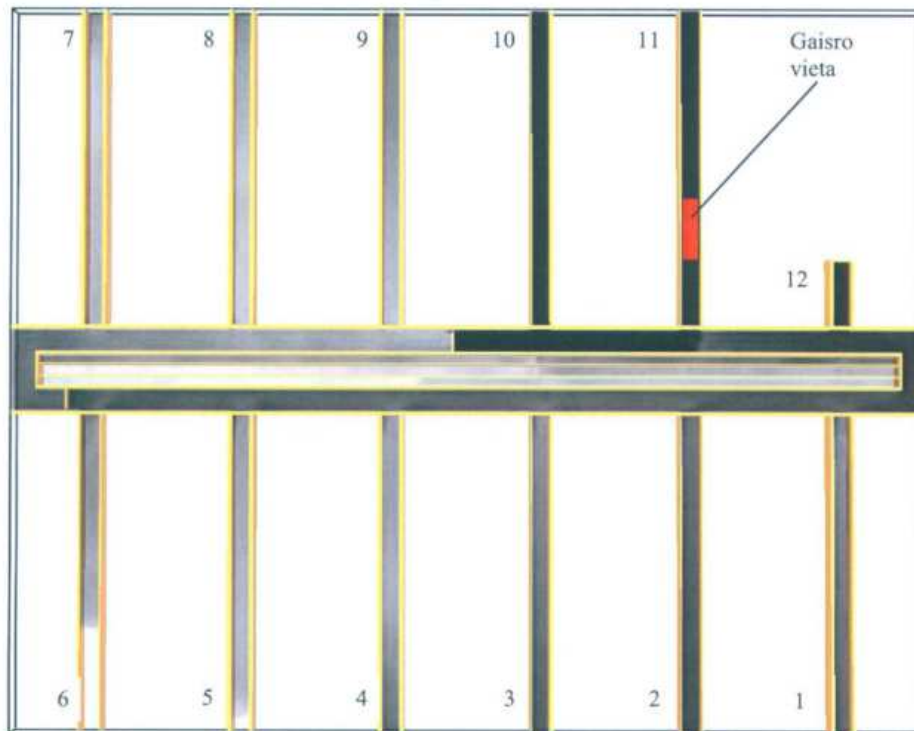

Figure 2.2.4-7. Smoke distribution in the technical channels of Building 158 at the end of the design fire

As seen in Figure 2.2.4-7, the densest smoke (depicted in black) is in the channels located near the fire zone, namely, channels No. 10+2 and the communication corridor adjacent to these channels.

The smoke itself will not affect the building or the stored compound, or will it impact the functions related to SSCs safety. During the fire, fire system sensors and sprinklers will be covered with soot. Therefore, after the fire, all these systems need to be cleaned and checked.

#### Evaluation of Fire Detector Response Time

Since fixed-temperature fire detectors IT-104 (or IT-105) are installed in the technical channels and they activate when the temperature reaches 70°C, taking into account their spacing (every 4 meters), the height of the channels, and assuming that the fire propagation rate is fast (because the spilled compound will be hot and easy to ignite), using the DETACT-T2 computer program, it is estimated that the fire detectors will activate in approximately 1.72 minutes (104 seconds) from the start of the fire.

The fire detectors in communication channel No. 11 (and channel No. 10) are duplicated and connected to separate fire detection system circuits; therefore, their non-activation in this context is not a concern. If a fire were to occur in other channels where the detectors are not duplicated, as indicated by the temperature distribution results in the channels, nearby channels (close to the fire source) will reach the detector's activation temperature. However, in such cases, the activation time will be longer, and this activation may be partially misleading because it will not be clear whether the fire has occurred in the channel or in the corridor.

#### Possibility of Spilled (Ignited) Compound Entry into the Canyon

In the building's construction, a stainless steel insert with flange joints is installed in a 300 mm diameter opening in the concrete floor of the compound canyon. The flange joint's thickness is 8 mm, and it has

## 2. FIRE SAFETY ANALYSES

fire resistance of approximately 14 minutes, which is greater than the projected duration of the spilled compound fire. Additionally, a flanged joint with the same thickness and material is used to connect the compound supply pipe (the total wall thickness of the pipe for compound supply and heating steam is 7.5 mm, with a fire resistance of approximately 11 minutes, also greater than the projected duration of the spilled compound fire).

During the compound supply, the canyon is completely sealed off from the communication channel. Since this flange connection is at the end of the pipe through which the compound is supplied, the pressure in this section of the flange is lower than in the compound supply pipe itself. Moreover, the flange is installed in the canyon floor, which has a total thickness of about 600 mm, ensuring its stability. As a result, the flanged connection or the pipe itself cannot leak or be sealed off.

Therefore, if the compound spills or a fire occurs in the communication channel, the fire resistance of the flange joint and pipes is greater than the projected duration of the compound fire. Consequently, fire will not spread to the interior of the canyon. However, it is necessary to check the condition of this flange/pipes and ensure that the nuts and bolts are tightened before each compound supply operation.

**Firefighting Possibilities:**

As indicated by the analysis, in the event of a fire, a significant amount of smoke will be generated. This smoke will impede visibility and pose a thermal radiation hazard near the fire source (calculations show that thermal radiation flux of approximately 4 kW/m<sup>2</sup> will be present at a distance of 4 meters from the fire source). Consequently, personnel will not be able to approach the fire zone and initiate firefighting on their own. Unless during the firefighting phase when the temperature starts to decrease. In any case, personnel must be properly equipped and use available respiratory apparatus with full face masks. Additionally, radiological conditions in the technical channels must be assessed before any firefighting operations.

**Impact on Personnel and Systems Due to Fire in the Technical Channel**

Because of the rapid generation of compound (bitumen) fire smoke, the most significant impact on personnel during the initial phase of the fire will be the presence of smoke. In the event of such a design fire, personnel must quickly evacuate from the technical channels; otherwise, rapid smoke filling of the channels and its toxic/radioactive effects on personnel, as well as the later high temperatures near the fire zone, will make it difficult to exit the channels (poor visibility, potential smoke inhalation, heat impact, thermal radiation, etc.).

The spread of smoke/temperature in the technical channels will not affect the structures or the stored compound in the canyons. There are no systems in Building 158 or its technical channels that respond to smoke or control other systems.

**Fire in Compound Canyons**

Under normal conditions, there are no fire hazards or ignition risks for systems/equipment in the compound canyons. They are separate compartments where the compound is stored, and under normal conditions, a fire cannot occur in the canyons.

As previously described, the canyons are separated (isolated) from each other by reinforced concrete walls. The openings for compound supply pipes into the canyons are sealed with stainless steel inserts, which have a 100 mm diameter opening for canyon inspection. The openings are left unsealed since they are not locked, and they can be freely opened/closed.

A fire in the compound canyons can only occur due to possible heat sources, which may include:

- Self-heating from the compound;

## 2. FIRE SAFETY ANALYSES

- Lightning strike;
- Radiological hydrogen generation within the compound;
- Human activities.

**Heat Release:**

The calculated heat release from the compound, which has a projected activity of  $1.85 \cdot 10^9$  Bq/kg, is approximately  $1.5^\circ\text{C}$  per year. Such a temperature increase can be disregarded due to heat dissipation, and also because the actual stored bituminous compound has an activity that is about 100 times lower. Temperature measurements of the compound have shown that the actual temperature in the stored canyons consistently stays within the range of  $5\text{-}18^\circ\text{C}$ .

**Lightning Strike:**

Building 158 (as well as Buildings 151 and 154) has a Class III lightning protection system. The lightning protection system for Building 158 consists of strip lightning rods installed on the roof of the building. The components of this system's resistance are periodically measured and evaluated against the project requirements. The results of recent measurements have shown that the lightning protection system meets the project requirements.

Additionally, it should be noted that Building 158 is not the tallest structure; nearby, there is a slightly taller Building 158/2 and a significantly taller Building 150. Next to Building 150, there is a tall chimney, making it more likely that lightning would strike taller neighboring buildings rather than Building 158.

**Radiological Hydrogen Generation:**

Calculations for hydrogen generation in the filled canyons of Building 158 were performed. It was determined that it would take 198 days for the minimal explosive hydrogen concentration to form in the canyon. The calculations were performed with a large margin of safety, not taking into account the substantial bituminous mass compaction and assuming that the bitumen activity is projected, i.e.,  $1.85 \cdot 10^9$  Bq/kg, even though the actual activity is 100 times lower -  $1.69 \cdot 10^9$  Bq/kg.

The Ignalina NPP measures hydrogen concentrations in the canyons every quarter. To date, no hydrogen concentrations have been detected. Hydrogen concentration is measured using a Draeger Multivvam II device, which, can measure hydrogen concentration in the range of 0 to 2000 ppm (0-2%), with an accuracy of 1 ppm.

**Human Activity:**

Access to Building 158 is restricted, and the building is in a controlled area. Entry into the canyons' interior is impossible due to the building's construction (with a total thickness of approximately 600 mm). All work in Building 158 is carried out only after submitting an application and obtaining permission, and such work is supervised by operational personnel. Necessary additional fire safety measures are indicated before work is performed.

However, careless/intentional behavior by personnel involving fire (such as performing various maintenance tasks, hot work, etc.) can lead to a fire. In this case, for a fire to ignite the compound (i.e., a source of ignition), it must come into direct contact with the compound inside the canyon.

Theoretically, without taking any measures and with a large quantity of compound and unrestricted air supply, a fire in the compound canyon could continue for a very long time (about 37 hours). This would exceed both the specified fire resistance of the metal hatch and the fire resistance of the building's structure. In this case, it is important to extinguish the fire using available systems.



## 2. FIRE SAFETY ANALYSES

The fire load in the canyons is very high. On average, each canyon contains about 2000 m<sup>3</sup> of compound (considering its density of 1200 kg/m<sup>3</sup>, the compound mass is 2400 tons). Since the heat of combustion for the compound (bitumen) is 40.95 MJ/kg, and the area of the canyon is about 407 m<sup>2</sup>, the fire load in the canyon is on average equal to:

$$(40.95 \cdot 2400000) / 407 = 2.4 \cdot 10^5 \text{ MJ/m}^2.$$

In a realistic assessment, the ignition source can only enter the filled canyon through the inspection hatch (with a diameter of 100 mm). Therefore, ignition of the compound is primarily possible at the location directly beneath the hatch/opening. Since both the hatch and the opening have relatively small diameters, it is impossible for a large ignition source to enter the canyon. Fire propagation within the compound is practically non-existent, and the compound will only burn as long as the ignition source is on its surface. Furthermore, when ignition starts with a flame, for the fire to continue to develop (for the material to continue burning), sufficient oxygen needs to enter the fire zone. If the volume of the space is very large, and there are no openings or the openings are small, the fire/combustion tends to smolder, can go out completely, or burn very slowly. Therefore, it is recommended to keep the inspection hatches of already filled canyons always closed and locked, and locking devices must be installed for this purpose.

Naturally, for the ventilation of one canyon, eight chimneys with a diameter of 100 mm are used, which are freely connected to the atmosphere. There are no more open openings. To determine whether a burning fire can develop/spread, it is necessary to assess the supply of oxygen to the fire zone. Typically, literature provides a parameter known as the opening factor, which is calculated as follows:

$$\frac{A_o \sqrt{H_o}}{A_t}$$

Where:  $A_o$  represents the total cross-sectional area of open openings through which oxygen can enter,  $H_o$  is the ratio of the product of the width and height of all openings to  $A_o$ , and  $A_t$  is the total surface area of all surfaces in the space.

Conservatively assuming that the canyon is filled with the compound, i.e., the distance from the compound to the canyon's ceiling is about 1 m, and knowing the length and width of the canyon (~36 \* 11.3 m), we obtain:

$$A_t = 2 \cdot (11,3 \cdot 1 + 11,3 \cdot 36 + 1 \cdot 36) = 908 \text{ m}^2.$$

$$A_o = \frac{\pi \cdot 0,1^2 \cdot 8}{4} = 0,063 \text{ m}^2.$$

$$H_o = \left( \frac{\pi \cdot 0,1^2 \cdot 8}{4} \cdot 0,1 \right) / 0,063 = 0,1 \text{ m}.$$

$$\text{Ventilation factor} = \frac{0,063 \sqrt{0,1}}{908} = 2,2 \cdot 10^{-5} \text{ m}^{-1}$$

This is a very low factor. The minimum provided venting factor is  $1 \cdot 10^{-2} \text{ m}^{-1}$  (and the maximum fire load for which normal combustion can occur at this venting factor is 126 MJ/m<sup>2</sup>), so in other cases, due to the lack of oxygen, complete combustion is not achievable.

Furthermore, it is possible to determine the air inflow and compare whether it is sufficient for complete combustion. Approximately, the potential air inflow (in kg/s) through openings can be calculated using the formula:

## 2. FIRE SAFETY ANALYSES

$$m_{oro} = 0,5 A_0 \cdot H^{1/2} = 0,5 \cdot 0,063 \cdot 0,8^{1/2} = 0,03 \text{ kg/s}$$

where  $H$  represents the total diameter of all openings, meters

The total combustion rate of the bitumen compound located in the canyon:

$$m_{kompaundo} = 0,0045 \cdot 407 = 18,3 \text{ kg/s}$$

Therefore, the compound (bitumen) cannot burn completely (usually, for proper combustion, there must be an excess of air, not an obvious deficiency, as in this case).

Therefore, it is clear that if the compound (bitumen) is ignited for any reason, it can only burn fully while there is air inside the canyon (it can only burn completely for a certain time until the oxygen inside the canyon above the compound is consumed). After that, due to a lack of oxygen, it will no longer burn fully (as indicated by the low vent factor and the amount of incoming air), but it may smolder or burn weakly.

Since the area of the canyon is approximately 407 m<sup>2</sup>, and the height between the compound and the canyon ceiling is about 1 m, the air volume in the canyon is ~407 m<sup>3</sup>. To burn 1 kg of compound (bitumen), about 11.2 m<sup>3</sup> of air is required, so over time, while consuming 407 m<sup>3</sup> of air, approximately 407/11.2 = 36 kg of bitumen can burn (because when the canyon is filled with compound, there is about a 5 cm layer of pure bitumen on top of it; the layer thickness is determined by the volume of poured bitumen). After that, due to a lack of oxygen, combustion will begin to diminish.

If a fire were to occur in the canyon, it would be limited by the building's structure and would not spread to adjacent canyons, even if the metal canyon inspection hatch/flange were damaged.

As previously mentioned, temperature sensors are installed below the hatch (about 60 cm above the compound) in the filled canyon area, and they activate when the temperature in the canyon exceeds 35 °C. Since a potential fire could occur near the temperature sensor, treating it as a fire temperature sensor with a trigger temperature of 35 °C, the conservative DETACT-T2 program calculated that it would signal a fire about 1 minute after the start of the fire.

Temperature change sensors DPS-038 are installed in the canyons (except for canyons No. 10 and 11), and they trigger when the temperature changes by 27 °C within 7 seconds. Since the DPS-038 sensors are installed in the already filled canyons, the distance from the compound to the sensors is about 1 m, and the distances between the sensors are about 4 m. Assuming a moderate rate of fire spread (since the stored compound in the canyon is not hot), and to obtain a more conservative result, it was assumed that the detector would trigger when the temperature changed by 27 °C within 60 seconds. In this case, these sensors would activate about 90 seconds (1.5 minutes) after the start of the fire.

In canyons No. 10 and 11, sensory measurement cables are installed, which give a signal when the temperature reaches 90 °C or changes by at least 70 °C within 10 seconds. The DETACT-T2 program calculated that in the case of a filled canyon (e.g., canyon No. 10), the sensor would signal a fire about 132 seconds (triggered by temperature) or 114 seconds (triggered by a temperature change).

Therefore, the more conservative response time for fire detectors is in the case of sensor measurement cables. Since the fire suppression system does not operate automatically, personnel may take up to a minute to reach and activate the canyon's water-based fire suppression system. Before that, it must be ensured that a fire has actually occurred. This can be done by monitoring the natural ventilation chimneys directly or with the help of video cameras, monitoring the readings of the canyon's air temperature sensors (which can be done by personnel located in room 711, and information about opening the hatch can be relayed via a portable radio station). Thus, it can be assumed that the time it takes to activate the fire suppression system will not exceed 5 minutes (detector response time 1.9 min

(or 114 sec) + personnel walking to the hatch 1 min + opening the hatch 1 min + 1 min for unforeseen circumstances).

### **Fire in the Utility Room (Room 120)**

This is a fairly large room measuring 73x6x3.2 m. In this room, along its north and south walls, there are water-based fire suppression system pipes with nozzles and junction boxes for the fire detection systems of the canyons and technological channels.

According to the fire hazard, the room is classified as Category Eg. There is no fire detection system in the utility room.

Access to the utility room is through a corridor located in Building 150. The doors separating Building 150's corridor and the utility room are made of sheet carbon steel with a thickness of 4 mm (fire resistance of about 7 minutes). These doors have a self-closing mechanism. Upon entering room 120 through these doors, there are second identical metal doors.

The corridor in Building 150 through which access to the utility room is possible is quite large (approximately 30x3x4 m). The floor in this corridor is covered with plastic. On the opposite side of the doors leading to the utility room, the walls of Building 150's corridor have a cable tray about 0.3 m wide at a height of approximately 3.5 m, and the cables in it are covered with fire-resistant material. Since the cables are quite far from the doors leading to the utility room, a fire originating from them will not spread into the utility room.

After inspecting the utility room itself, the only potential sources of fire/ignition that could affect the water-based fire suppression system pipes are low-voltage (36V) transformers (transformer dimensions are approximately 0.4x0.2x0.4 m). There are several of these transformers in the room. Some of them are installed quite far from the pipes, while others are right next to them (the minimum distance between the pipe and the transformer is about 0.2-0.3 m). Although the voltage of these transformers is low, a fire can still occur in such a transformer due to a short circuit. It is not clear how much combustible material can be in such a transformer, but since the transformer is not large, it is assumed that there could be about 2 kg of combustible materials (windings, insulation, etc.). It is also assumed that the fire power in such a transformer is equal to 50 kW (for comparison, in large electrical panels containing several kilograms of combustible materials, the fire power is about 200 kW).

The duration of the fire is determined by the equation:

$$\chi \cdot m \cdot \Delta H_c = \int Q dt$$

where:  $\chi$  - combustion efficiency (e.g., 80%);  $m$  - mass of combustible materials, kg;  $\Delta H_c$  - heat of combustion (16400 kJ/kg);  $Q$  - fire power, kW.

$$t = \frac{\chi \cdot m \cdot \Delta H_c}{Q} = \frac{0,8 \cdot 2 \cdot 16400}{50} = 520 \text{ s} (\approx 8,7 \text{ min}).$$

A fire in the transformer due to the characteristics of the room will be localized.

The wall thickness of the fire-fighting water pipe (diameter 219 mm) is 6 mm. Evaluating its fire resistance, it was found that the pipe's fire resistance is approximately 9 minutes. So practically, it's the same as the project fire duration. Since this system is crucial for extinguishing fires in the canyons, it is recommended to paint the pipes with fire-resistant paints at the locations in the utility room where transformers are installed under the fire-fighting system pipes, ensuring that the pipes will not be damaged in case of a fire in the transformer.

## 2. FIRE SAFETY ANALYSES

Assuming that the flame height is equal to the height of the transformer's body, it was calculated that the pipe could theoretically be damaged (the temperature inside would be higher than the steel's damage threshold, regardless of the fact that there is always water in the pipes) when the transformer is less than 0.6 meters away from the pipe (in this case, it was determined that the temperature of the hot gases above the flame at a height of 0.6 meters will be about 465°C, which is equal to the steel's damage threshold).

The total length of the pipe painted with fire-resistant paints at the transformer location should be at least 0.8 meters (i.e., 0.4 meters on one side and 0.4 meters on the other side from the center of the transformer). An analysis of filling the room with smoke due to such a fire was also conducted. The analysis showed that throughout the fire duration, only about half of the room can be filled with smoke (i.e., the smoke layer in the room due to the project fire would be only about 1.9 meters above the floor to the ceiling, which will not affect personnel involved in extinguishing such a project fire. However, there are no primary fire-fighting means in the utility room. Therefore, it has been recommended to install fire extinguishers in it.

**Fire in the Control and Measurement Room**

The control and measurement rooms are small rooms located on the exterior side of the communication channels. These rooms have no connection to the communication channels themselves because they are separated from them by concrete blocks approximately 0.4 meters thick. Access to these rooms is only from the roof of building 158 (at level +6.25). All doors in these rooms are metal and locked. These rooms contain signal cables connected to the compound temperature measurement sensors TCM-0979, and the junction boxes for these cables. There are no flammable materials in these rooms (the room category according to fire and explosion hazard is Eg), and these rooms have no direct connection to the compound. Therefore, a fire in these rooms is not further analyzed.

**Conclusions**

1. The actual fire resistance of the supporting structures of building 158 is as follows:
  - For supporting walls - 120 minutes;
  - For canyon ceiling panels - 75 minutes;
  - For columns - 75 minutes.
2. Each canyon, when filled with compound, constitutes a separate fire section separated from other canyons by reinforced concrete walls and ceilings. The weakest element is a metal steel sheet with an observation hatch built into the canyon ceilings.
3. The spread of fire within building 158 and its spread to other buildings is not possible due to the characteristics of its construction materials (reinforced concrete, metal, bricks). The fire can only be localized.
4. Smoke spread propagation due to partially sealed hatches separating the technical channels of building 158 from the service room is partially restricted. Smoke propagation between technical channels and the bitumen room (or vice versa) is also partially restricted.
5. Personnel evacuation from the building is not complicated, but evacuation routes are not marked, and in the event of danger, especially for those in the technical channels, it may not be clear where to evacuate.
6. A significant emphasis is placed on fire safety at Ignalina NPP. This is achieved by implementing relevant fire safety regulations and normative documents.

## 2. FIRE SAFETY ANALYSES

7. Fire detection systems are installed for fire detection in the technical channels and canyons of building 158. The quantity of detectors in these systems is sufficient, and their placement complies with the requirements. In canyons No. 1-6 and 12, where the JĖTIC-038 fire detectors can no longer reliably ensure the operation of the fire detection system/firefighting water system due to resource depletion, compensatory measures for fire detection were performed:
  - Were installed air temperature sensors in the canyons;
  - Continuous monitoring of building 158 with video cameras, which allows for the detection of emerging smoke through canyon ventilation chimneys and taking appropriate measures in case of a fire.
8. In Building 158, there are stationary fire extinguishing systems sufficient for extinguishing possible fires as follows:
  - The canyon water fire extinguishing system has been installed for a long time, and it is impossible to evaluate its condition because the canyons are inaccessible. Visual evaluation of the system from photos suggests that its condition is good.
  - Before starting to operate the canyon, the water fire extinguishing system of that canyon is inspected. The inspection of the last canyon No. 11 showed that the system worked well even after 20 years.
  - Visual assessment of the fire extinguishing foam system in the technological channels indicates that the system's condition is normal. However, the condition of the external dry hydrants on the building needs to be checked and repainted after removing rust in some places.
  - After evaluating the properties of the fire-fighting foam vehicle available at VFRS, it was determined that the current foam quantity (2400 liters) in the vehicle is sufficient to conduct a 15-minute "foam attack" and extinguish a fire in the technological channels (only 1533 liters of foam will be consumed for this purpose). It was also determined that an additional 2200 liters of foam will be needed on the fire scene to provide for two more "foam attacks" of 15 minutes each, due to potential re-ignition of bitumen in the technological channels. This additional foam will be transported to the fire scene by VFRS vehicle from the available reserve.
9. There are no primary fire extinguishing means in Building 158. In the event of a fire, employees use fire extinguishers located in Building 150.
10. The properties of bitumen compound highly depend on the salt content in it. In the compound, the salt content (NaNCh) is limited to 30 % by mass, which means that, in terms of fire hazard (spontaneous ignition, detonation, etc.), this compound is not highly dangerous, and its combustion properties are practically the same as pure bitumen.
11. Possible fires in buildings adjacent to Building 158 do not pose a threat to Building 158.
12. The inspection of the technological channels has shown that the communication channels (their floors, ceilings, and walls) are constructed from non-combustible materials, such as reinforced concrete blocks, with no surface coverings, and there are no devices that could pose a fire/ignition hazard in the channels. Therefore, under normal conditions, a fire cannot occur there.
13. In the hypothetical scenario of a fire in the communication corridor, high temperatures are only reached in the zone of the communication corridor where the fire has occurred. In the communication channels (i.e., in those places through which communication with the canyon is possible), temperatures are significantly lower and do not pose a danger to the stored compound.

## 2. FIRE SAFETY ANALYSES

14. In the hypothetical scenario of a fire in the communication channel, high temperatures are only reached in the technological channel where the fire has occurred. Such temperatures do not pose a danger to the stored compound as long as the integrity and sealing of the metal cover of the canyon (or the connecting canyon to the compound supply pipe) are ensured.
15. Access by personnel to the premises of the technological channels during or after a fire is possible only after assessing the conditions, including radiological conditions, and taking appropriate safety measures.
16. There are no devices in the compound canyons that could pose a fire/ignition hazard. Due to the properties of the compound itself, hydrogen release does not occur, and the temperature rise in the compound to the concentration of salts or the spontaneous ignition limit of the compound is not possible under normal conditions. Therefore, spontaneous combustion in the stored compound cannot occur.
17. In the event of a fire in the canyon, full combustion of the compound is possible only for a certain period, until the air (oxygen) present in the canyon above the compound is consumed for combustion. After that, due to limited air supply to the fire source, the compound's combustion will either extinguish or burn weakly.
18. Secondary (non-radiological) effects due to potential fires in Building 158 will not have a significant impact.
19. When analyzing fire hazards, four hypothetical fire scenarios in Building 158 were developed, which could potentially result in radiological consequences for employees, residents, and the environment. These scenarios include (1) a fire in the communication corridor of the technological pipelines, (2) a fire in communication channel No. 11 of the technological pipelines, (3) a fire in the canyon filled with bitumen compound, and (4) a fire in canyon No. 11.

**Recommendations and safety improvement measures**

After performing FHA for Building 158 recommendations were proposed (for instance, replace the external doors of the bitumen storage and issuance node located in Building 150 with fire-resistant doors; develop and coordinate a strategy with VFRS for canyon firefighting through natural ventilation chimneys; Firefighters extinguishing the fire and assisting SE Ignalina NPP employees working in areas with increased emission concentrations are recommended to provide maximum respiratory protection, i.e., to wear self-contained breathing apparatus with a full-face mask and others). Appropriate safety improvement measures were implemented.

**2.2.4.4. Periodic review and management of changes**

The review of fire safety analysis is carried out within the framework of the PSR every ten year. The last PSR for building 158 was performed in 2021 [5.45].

The last Fire Safety Analysis for building 158 was performed in 2015 [5.46].

The impact of modification on fire safety SSCs important to safety is analysed in planning justifying modification.

**2.2.4.5. Regulator's assessment and conclusions on fire safety analyses**

After review of the SAR "Safety analysis report for Existing buildings used as interim storage for bituminized waste, prepared by SKB, 2000", which has been performed by Swedish company SKB, VATESI in 2000 issued permission for operation of the bituminized waste storage facility (Building 158)(BWSF).

In 2011 VATESI reviewed PSR report “Interim storage of bituminized radioactive waste at Ignalina NPP Building 158“. The report included an assessment of possible internal and external fires, assessed the technical and organizational measures for fire prevention and fire consequences mitigation. The submitted report justifies that the distance between the BWSF and other buildings is large, so that if a fire were to break out in adjacent buildings, the BWSF would not be at risk from external fires. Twenty-four hours a day visual monitoring of the high quality fire protection of the BWSF is carried out by means of a CCTV camera installed on the roof of the adjacent building 150. The CCTV camera is equipped with control, power and video signal cables, which are connected to a monitor located in the 711 room of Building 150, which is permanently staffed. This TV system is local and does not affect adjacent units and systems during normal operation or failures. During VATESI PSR report review, it was confirmed that the fire protection system of BWSF meets the requirements of fire safety legislation.

In 2014, VATESI approved the Nuclear Safety Requirements BSR-1.7.1-2014 "Fire Safety Constructions, Systems and Components Important to Safety of NI ", which established that for all NIs shall be performed FHA. VATESI reviewed the FHA report of the BWSF provided by SE Ignalina NPP in 2015. The FHA report provided recommendations for improving the fire safety of BWSF. VATESI constantly supervised the implementation of these recommendations until they were implemented.

VATESI reviewed BWSF PSR report “Interim storage of bituminized radioactive waste at Ignalina NPP Building 158“ in 2021. The report evaluated the fire protection system, identified potential internal and external fires, and analyzed them. VATESI reviewed and approved this report.

VATESI carried out an inspection at the BWSF in 2020. VATESI inspectors checked the condition (identification markings, complete set of devices, functionality, cleanliness and others) of the stationary fire detection, alarm and extinguishing systems of BWSF and how their technical maintenance is carried out. VATESI did not find any violations and non-conformities with good practice during that inspection.

After analyzing everything above in this point, VATESI concluded that the FHA of BWSF performed by the licensee are adequate.

## **2.2.5. Cemented Waste Storage Facility (Building 158/2)**

### **2.2.5.1. Types and scope of the fire safety analyses**

Temporary storage building of the cemented radioactive waste (Figure 2.2.5-1) is intended for storage of 6300 F-ANP containers filled with eight containers of cemented waste. Temperature in the storage is always kept to be above +5 °C. Loading, unloading and transportation of containers in the storage is done by the remotely controlled electrically driven bridge crane with a loading capacity of 10 tonnes. For the moment (October 2023), there are 2773 containers (F-ANP) with solidified (grouted) RW stored in building 158/2.

According to the proposed technology, the removal of graphite rings and sleeves from the dismantled reactor channels is performed at reactor units. The removed segments of graphite rings and sleeves then are put in 2001 steel drums, which afterwards are transferred to building 150 (using modified K-3 transport container) for further radiological characterization. After that, the characterized 2001 drums are put in F-ANP containers (eight drums in one container) and transferred to building 158/2 for subsequent storage. So in general, the proposed method of storage of graphite waste generated during the dismantling of the reactor channels is chosen analogous to the method of cement solidified waste storage — in 2001 drums, further contained in the F-ANP containers of reinforced concrete.

Currently it is envisaged to store about 160 same type of containers (F-ANP) loaded with irradiated graphite, i.e. graphite rings and sleeves (which will be placed metallic 200 l drums) in the building

158/2. For the moment (October 2023), there are 9 containers (F-ANP) with irradiated graphite stored in building 158/2 [5.47].



Figure 2.2.5-1. Partial view of building 158/2.

Building 158/2 is a one storey reinforced concrete building designed for container storage. The building has dimensions of  $\sim 156 \times 54$  m and a height is  $\sim 14.1$  m (Figure 2.2.5-2). Storage area (room 101) has dimensions of  $\sim 144 \times 54$  m and the area of  $\sim 7671$  m<sup>2</sup> (volume  $\sim 100000$  m<sup>3</sup>).

It is a very large building consisting mainly of the container storage (96 %) area and a small building area (4 %) containing ventilation systems as well as necessary electrical and control areas. At level +4.50 m there is a service passage to building 158. Normal personnel access to building 158/2 is done via the mentioned passage.



Figure 2.2.5-2. Partial inside view of the building 158/2



2. FIRE SAFETY ANALYSES

The temporary storage area (room 101), the reloading area (room 103) and the crane maintenance area (room 204) are one common area not separated between each other. The reinforced concrete wall along the axis 25 (Figures 2.2.5-3, 2.2.5-4) exists from level 0.00 to +6.50 m and protects (separates) the reloading area from the container storage area.

Storage area is not attended area, therefore there are no personnel in it during normal operating conditions.

As building is mainly constructed from reinforced concrete, the fire spreading via building structures is not possible.

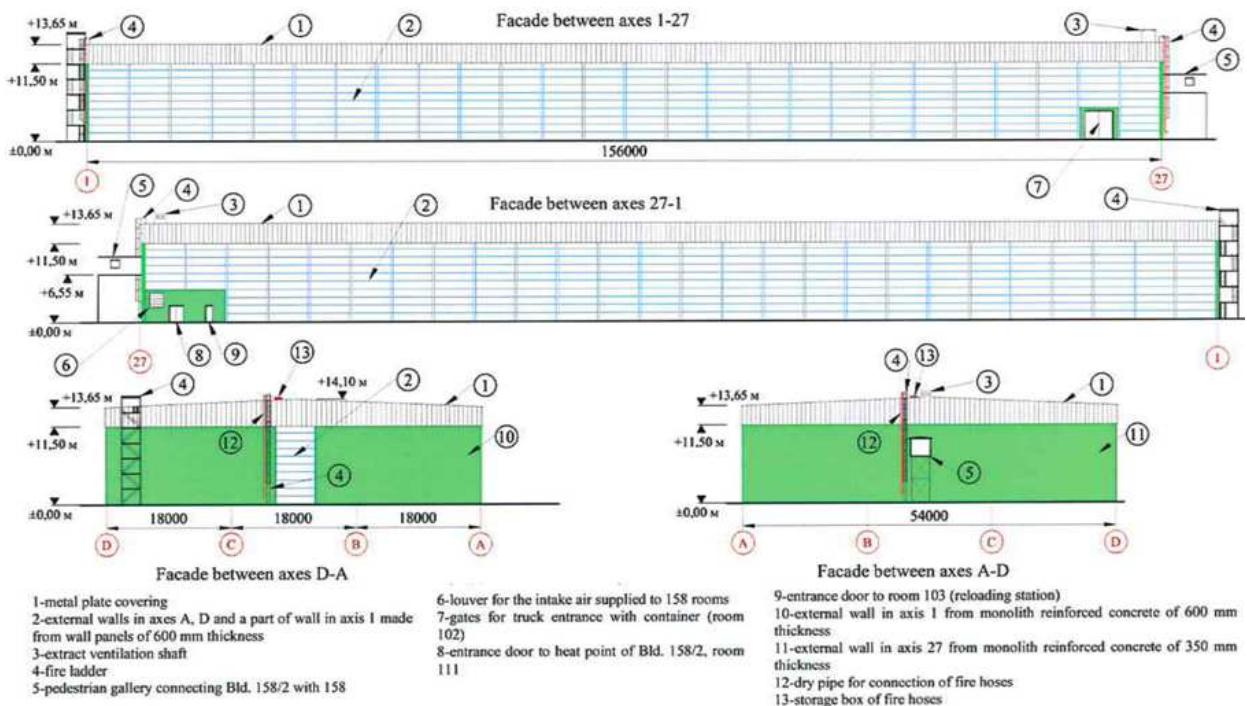
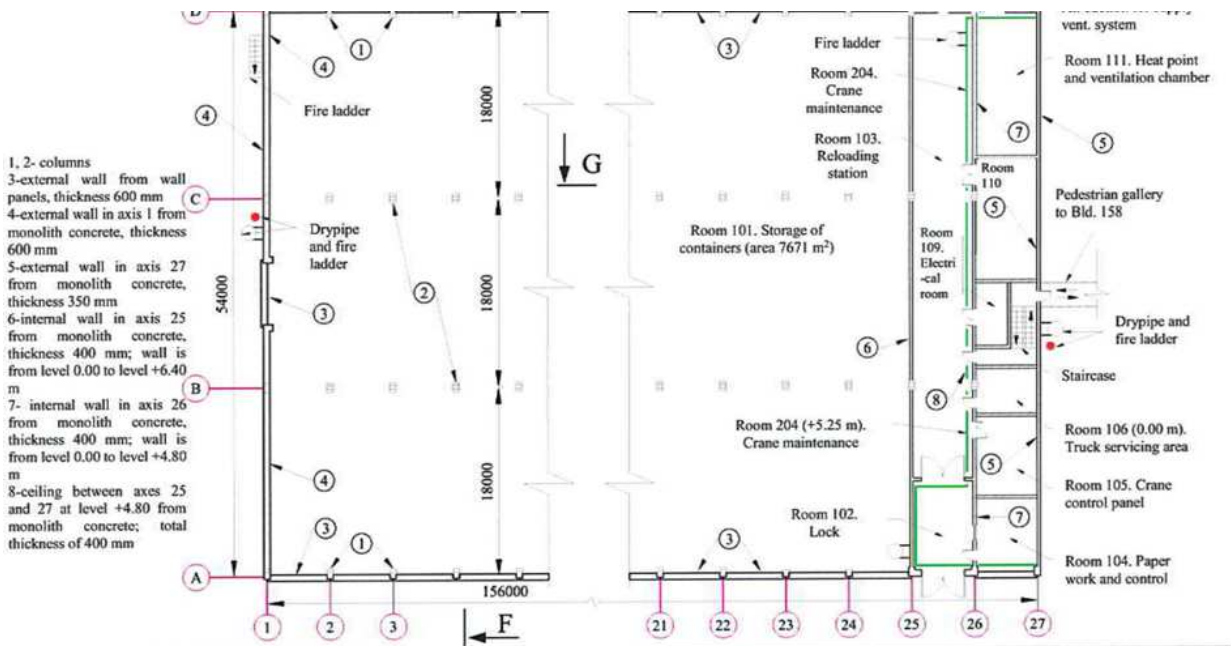

Figure 2.2.5-3. General view of the building 158/2

## 2. FIRE SAFETY ANALYSES

Figure 2.2.5-4. Plan of the building 158/2 (1<sup>st</sup> floor, level 0.00 m)**Fire loads**

Currently in the building 158/2, the solidified waste in the steel drums, which are placed in the reinforced concrete F-ANP containers, are stored. This represents an encapsulation of the combustible waste in a manner that ignition of the encapsulated waste can be excluded.

The fire load in the storage area is very low. It mainly consists of materials for necessary electrical installation like crane cables. Therefore, due to the big area of the storage, the fire load density is nearly 0 MJ/m<sup>2</sup>. Therefore, such fire load can't lead to the fires with high temperatures, besides crane cables are far above containers with radioactive waste.

The remaining rooms (104, 105, 106, 109-111) contain small amounts of combustible materials consisting mainly of:

- Electrical equipment in rooms 104, 105, 109 and
- Small amounts of cables assigned to ventilation system in rooms 110 and 111.

So, the facility could be assigned to the lowest – category 3 fire load. These fire loads were taken into account during designing of the building and related fire protection measures as well as fire detection and firefighting equipment.

Graphite is practically non-combustible material, then it is not expected fire load density increase in the storage area with containers (F-ANP) with irradiated graphite.

**Building compartmentalisation**

All walls, columns, ceiling consists of structural elements of non-combustible materials. The thickness of outer walls is 60 cm, except the eastern wall, which has a thickness of 35 cm. Such thickness represents a sufficient protection against external fires.

## 2. FIRE SAFETY ANALYSES

The roof is made from inner reinforced concrete part and outer part partially consisting of combustible sheets (due to PVC membrane Wolfin GW SK).

The inner pre-cast concrete walls have a thickness usually of 35-40 cm.

The building comprises a fire compartment sufficiently separated from neighbouring buildings by walls and distance.

The distance to Building 158 is about 6 m. This distance together with the outer walls of both buildings is sufficient to avoid fire/smoke spread between both buildings.

The columns and ceiling in electrical/mechanical part of the building are designed for fire resistance at least for 30 minutes (REI30). Therefore, this part of the building can be assumed as a fire sub-compartment. All internal and external doors and gates are metallic. Doors are with self-closing mechanisms.

Rooms 101-104, 106, 110, 111 and 204 are assigned to category Eg according to fire and explosion hazard. Rooms 105 and 109 are assigned to category Cg according to fire and explosion hazard.

#### 2.2.5.2. Key assumptions and methodologies

The key assumptions and methodologies is similar to that specified in Section 2.2.3.2 of this NAR.

#### 2.2.5.3. Fire phenomena analyses: overview of models, data and consequences. Main results.

##### Fire scenario 1. Truck fire in building 158/2

The truck with graphite waste temporary stops in lock (room 102), and then enters room 103 for unloading of the waste package. Operations on unloading of the waste package are remotely controlled and supervised. No personnel is present in room 103. Therefore, practically the only fire source, which could result in temperature increase in building 158/2, is the truck (Figure 2.2.5-5).



Figure 2.2.5-5. Waste package unloading from truck in room 103

For that case, a simple computer model using Fire Dynamic Simulator (FDS5, included into software Pyrosim2012) was created of the building 158/2. The validation and verification of this software is presented in NREG-1824. In the computational model an important role play the dimensions of the grid cells. In case of bigger cells the results are elevated (thats more conservative), in case of smaller cells – more precise. This was also demonstrated in the other report on FHA. As building 158/2 is rather huge building, therefore to get a global understanding about the level of the temperatures which could affect stored containers a computer model with  $0.5 \times 0.5 \times 0.5$  m cells (this also allowed to save modelling time) was created (Figure 2.2.5-6). The fire effect was 11000 kW. In the model in order to get conservative result it was assumed that half of the storage room is loaded with containers.

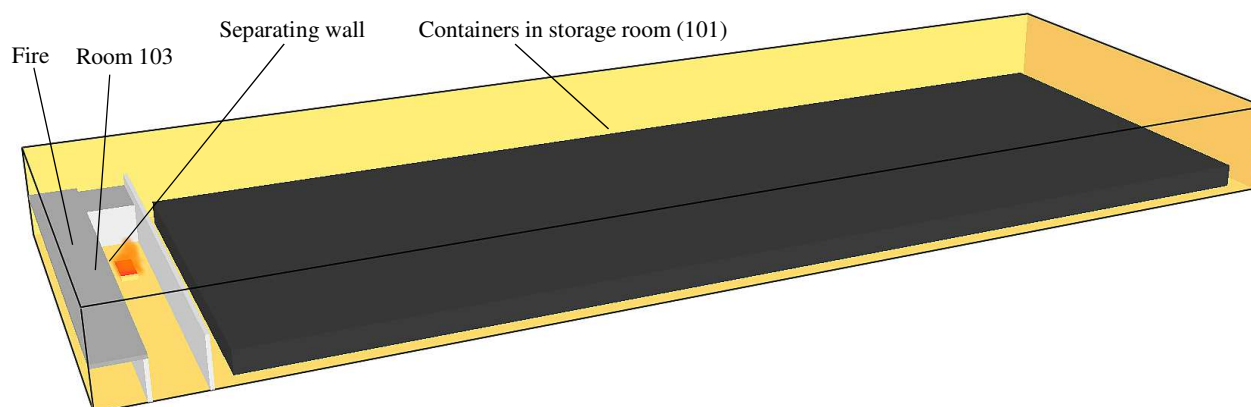

Figure 2.2.5-6. Simplified model of the building 158/2

The obtained results show that until the beginning of fire extinguishing actions the highest temperatures will be in the fire area – in room 103.

Smoke practically immediately starts to fill building area around the track and at the level of building roof flows to the storage area (room 101). After about 2 minutes, the end wall of room 101 is reached by smoke, so about 1/3 (the upper part only) of the storage room is filled with smoke.



Figure 2.2.5-7. Smoke filling in the building 158/2 after 2 minutes from the start of the design fire

After about 5-6 minutes, the room 103 is completely filled with smoke, while in the storage room the smoke layer is about 2/3 from the roof level. The storage room is almost completely filled with smoke after about 12-15 minutes. Further on, as the fire progresses, the density of smoke increases.

Track fire will also result in temperature increase in building 158/2, especially in rooms 101 and 103. Temperature fields in Figures 2.2.5-7, 2.2.5-8 show, that after 30 minutes (i.e. at a time, when fire extinguishing actions will start) from the beginning of the design fire the average temperature in the

room 103 will be in the range from  $\sim 60^{\circ}\text{C}$  to  $120^{\circ}\text{C}$ . Due to huge volume of building 158/2 the flame “sucks” air from building 158/2 volume and cools.

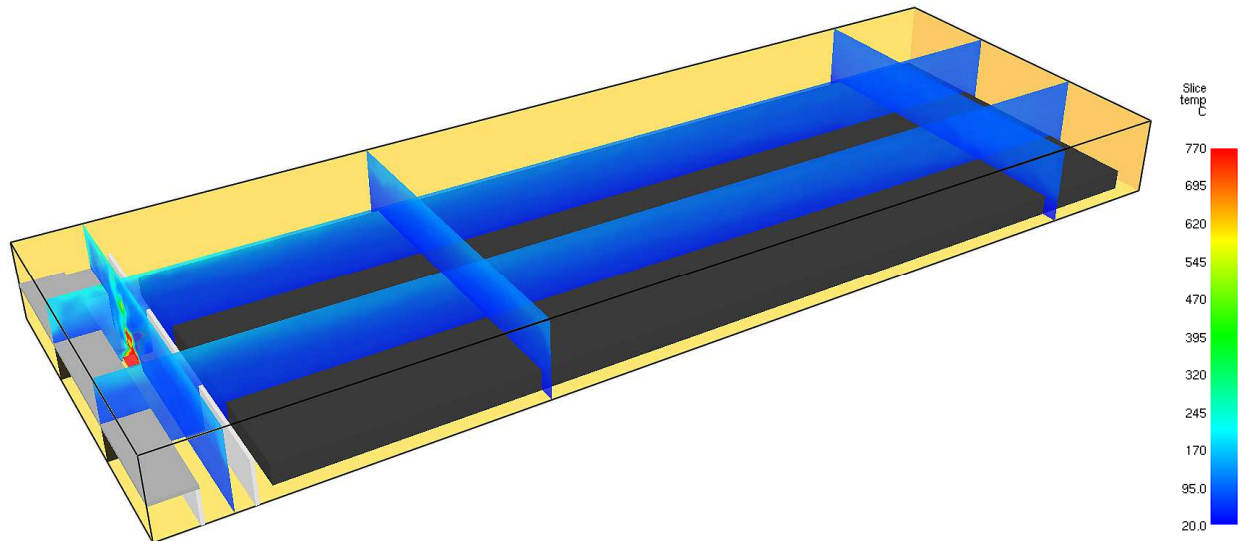

Figure 2.2.5-8. Temperature fields in the building 158/2 after 30 minutes from the start of the design fire

Despite of that, the temperature in the crane area above the fire can be up to  $420\text{--}470^{\circ}\text{C}$ . If in case of fire the crane remains directly above the truck, the crane might be damaged (crane structure is composed of metallic girders, which have a least thickness of 8 mm; critical temperature for metal is about  $470^{\circ}\text{C}$  and usually fire resistance of metallic structures are very low and in case of 8 mm thick metal sheet can be only about 11 minutes). Therefore, if fire starts in room 103 it is necessary to drive the crane far away into room 101 in order to avoid its drop on container/truck/separating wall.

In room 101, the temperature in the upper level (at roof) is mostly in the range of  $120\text{--}170^{\circ}\text{C}$ . From level 0.00 m till +6.50 m (the levels range where containers can be loaded in room 101) of the temperature is in range of  $60\text{--}80^{\circ}\text{C}$ . Such temperature will not have influence on stored concrete containers with graphite waste.

### Fire extinguishing

Powder fire extinguishers and carbon dioxide ( $\text{CO}_2$ ) can be used for primary fire extinguishing. There are no powder-sensitive devices near the fire source. After the fire, equipment that can be sprayed with powder should be cleaned and, if necessary, inspected. When extinguishing a fire with  $\text{CO}_2$  extinguishers, the equipment/room where the fire is being extinguished is not contaminated with the extinguishing agent, and the  $\text{CO}_2$  gas also cools the overheated parts.

Foam and water can be used to extinguish a heavy vehicle fire. After a certain period, foam loses stability and starts to "break down" becoming soapy water, with a quantity of about  $5.4\text{ m}^3$ . It is likely that most of the water will be retained by the structure of building 158/2. After the fire, using a mobile pump, the water should be transferred to an appropriate container, and a decision regarding its further treatment should be made after water analysis.

Even without taking any fire extinguishing actions truck fire can last up to 1 hour and maximum fire effect is about 11000 kW. The determined fire resistance of building 158/2 structures is sufficient.

## 2. FIRE SAFETY ANALYSES

The number of fire extinguishers placed in rooms 102 and 103 is sufficient for track fire fighting in its initial stage (assuming operation time of 60 s with both fire extinguishers a fire of 2200 kW at 50% efficiency of fire extinguisher can be put out). If fire extinguishing by personnel fails then the VFRS will have to extinguish track fire.

According to analysis fire fighting actions could start after about 30 minutes of fire occurrence and fire extinguishing time could be about 15 minutes.

When entering the building the radiological situation should be assessed and as the high temperature and smoke (the results have shown that until the beginning of extinguishing actions the room 103 and 101 will be completely filled with smoke and this will result in poor visibility) will be in the building it is necessary for fire fighters to be adequately dressed and wear full face mask with air supply for breathing.

Fire fighters may use foam or water (the decision will be taken by the Manager of fire extinguishing works). VFRS has enough resources (foam cars, hoses cars, etc.) to extinguish track fire.

As indicated in Figure 2.2.5-9 for fire extinguishing there are few fire hydrants (GH-56, 55, 29, 23) installed near building 158/2. In case of necessity the hydrants can be used by VFRS.

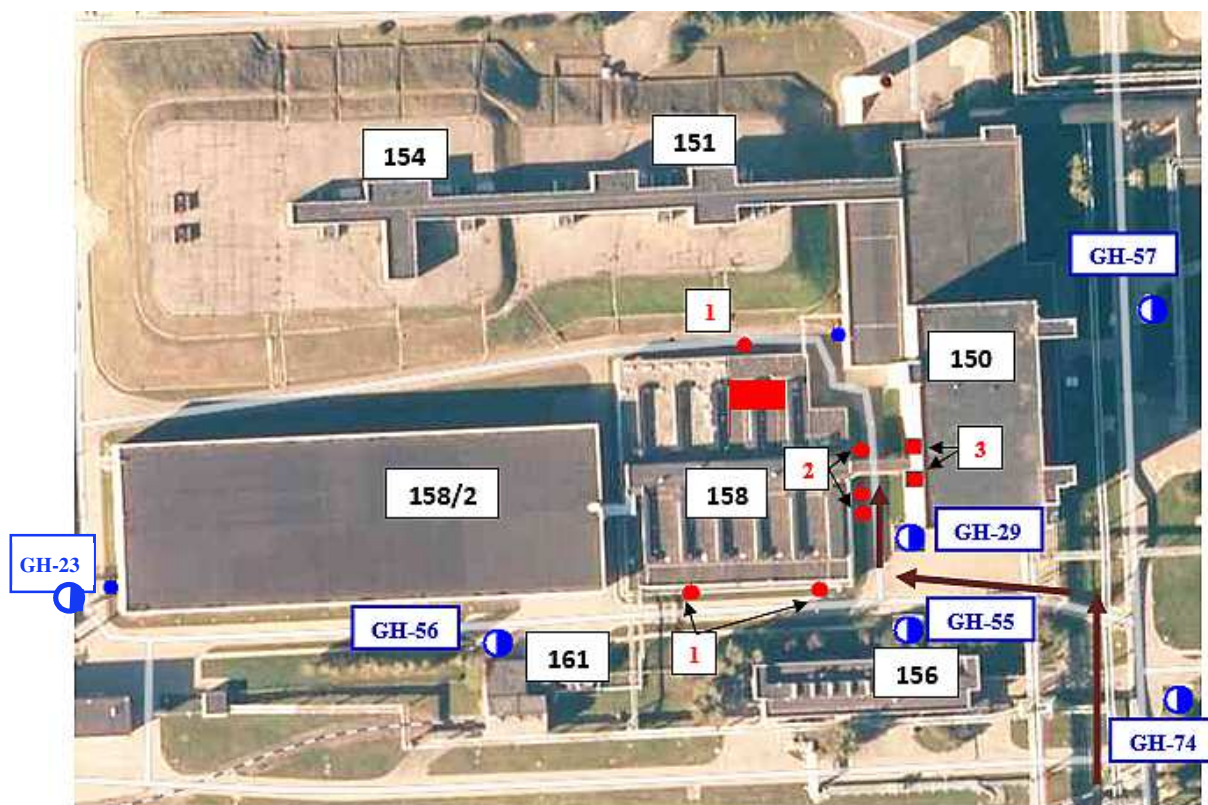

Figure 2.2.5-9. Fragment from Accident liquidation plan No. 7 (for building 158)

Foam car Renault Midlum 220.14 has 4000 litres of water and 400 litres of foamer, a maximum water pump flow rate is 2700 l/min, as well as few ZIL branded vehicles with a water capacity of ~2500 l, foamer ~130 l, maximum water pump rate of ~2400 l/min. The foam supplied is of medium

## 2. FIRE SAFETY ANALYSES

repeatability (i.e., repeatability  $\sim 100$ ). Water for foam preparation and foamer are taken from the respective tanks installed on the mentioned fire trucks (i.e. these truck are completely autonomous, it is not necessary to waste time by connecting to hydrants, etc., and fire extinguishing can be started immediately; the fire-fighting time according to the available water quantity – 12 minutes and during this time  $432 \text{ m}^3$  of foam is generated).

VFRS indicated, that the extinguishing mixture contains 6 % foam and 94 % water, then during a second  $6 \times 0.06 = 0.36 \text{ l}$  of pure foamed and  $5.64 \text{ l}$  of water will be used. As a result, with the volume of a foamer the foam generation can last approximately  $400 / 0.36 = 1111 \text{ s}$  or  $\approx 18$  minutes, and water will be enough for an infinite time (when the fire truck is connected to a fire hydrant). During one attack (15 min.) About  $540 \text{ m}^3$  of foam can be generated. This amount is sufficient to cover the truck (truck volume is about  $2 \times 6 \times 2.5 = 36 \text{ m}^3$ ) with a foam and extinguish truck fire. During that time about  $5.4 \text{ m}^3$  of water (including foamer) will be used. This water will mainly be isolated by building structures and will accumulate in room 103. As room floor area is about  $270 \text{ m}^2$ , the water height will be about 2 cm (room is not equipped with drainage system). It is likely that the water will not be contaminated, however it will have to be confirmed by appropriate analysis.

**Fire scenario 2. Fire outside the building 158/2**

As indicated in Figure 2.2.5-10 the building 158/2 is surrounded by other buildings. Most of them do not pose any fire hazard, however combustible materials such bituminised waste are stored in nearby located building 158. The FHA of these building 158 was done in Section 2.2.4 of this NAR.

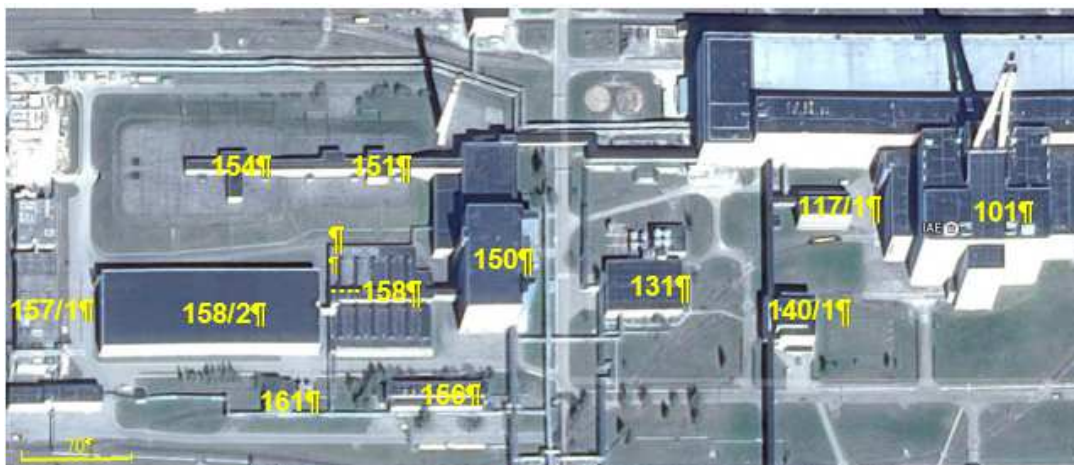

Figure 2.2.5-10. Location of the main buildings in Ignalina NPP site

The steam boiler station is located approximately 140 m away from the nearest building, which is the building 158/2. The primary fuel for the boiler house is natural gas, with diesel fuel as a backup. Adjacent to the steam boiler station, there is a  $1000 \text{ m}^3$  diesel fuel storage facility consisting of two tanks, each with a capacity of  $500 \text{ m}^3$ . The tanks are equipped with fire extinguishing systems, and to prevent fuel leakage in case of tank damage, they have double walls. Taking into account these facts, the possibility of a fire outbreak or fuel leakage from the tanks can be ruled out.

However, within the framework of Project B2, a conservative assessment of the fire impact on waste removal complexes located approximately 150 m from the boiler house was carried out. This distance is similar to the closest building 158/2. By making several conservative assumptions (fuel spill and ignition, fuel spreading over various surfaces, etc.), it was determined that the impact at this distance

## 2. FIRE SAFETY ANALYSES

would be very minimal (heat flux through radiation would not be significant, approximately 2.3 kW/m<sup>2</sup>). Since the building 158/2 is also at a similar distance (~140 m) from the boiler house, the impact of a diesel fuel fire (specifically, heat flux through radiation and temperature) would be somewhat shielded by the pure bitumen storage building (located between the boiler house and the building 158/2). Therefore, the impact on the building 158/2 would be negligible. However, in the case of a diesel fuel fire, smoke could envelop the buildings 158/2 and 150, and it could enter the buildings through the ventilation system. High-temperature smoke would not reach the buildings since it would dissipate and cool in the air, but the smoke itself could enter the buildings.

As mentioned, the boiler house also burns natural gas, and it is connected to the natural gas pipeline. Natural gas is sourced from the Rudki–Minsk–Vilnius pipeline, consisting of 95.6% methane, 2.8% nitrogen, and 1.6% other hydrocarbons. An assessment of the gas explosion was conducted for Solid Waste Management and Storage Facilities (B3/4 project) (since this gas supply pipeline passes very close to this complex), but the conclusions can be applied to the nearest buildings 158/2 and 150 as well.

The gas explosion analysis showed that even in the worst-case scenario (pipeline rupture and gas release), a gas explosion is highly unlikely. The probability of a gas cloud ignition leading to an explosion without detonation is very low. In such a case, the explosion pressure would be less than 4 kPa. With such pressure, the buildings within the explosion zone would not experience any consequences.

If, however, the worst-case scenario occurred, and a detonation occurred due to ignition closer than 50 meters from the building, the building would be affected by overpressure exceeding 30 kPa. Such overpressure could damage the structures of the buildings 158/2 and 150. Nevertheless, the 95th percentile frequency of such an explosion is low, equal to  $1.07 \times 10^{-7}$ . Therefore, the further impact analysis of the boiler house fire on the buildings is not performed.

### Conclusions

After performance of FHA on different graphite waste management steps and taking into account the graphite waste properties, the following general conclusions can be made:

- The main structural elements of the building are made of non-combustible materials and can withstand the effects of fire for a certain period and limit the spread of fire.
- Fire/smoke containment in building 158/2 is effectively ensured through the use of fire compartments.
- Main and alternative evacuation routes are provided for employee evacuation, and the evacuation from the building is relatively straightforward.
- A fire detection system is installed in all building areas (except the temporary storage area for containers) capable of detecting potential fires.
- In the event of a heavy vehicle fire, a temperature increase in the temporary container storage room (101) is possible, but the temperature will not affect the safety of F-ANP containers with radioactive waste.
- Various types of fire extinguishers are strategically placed throughout the building to control/extinguish any potential fires.
- No additional measures for fire detection, fire fighting are required to be installed in the analysed rooms/buildings where graphite waste management takes place;
- Fire spreading in rooms/buildings where graphite management takes place is limited due to properties of structures/buildings of these rooms/buildings;



## 2. FIRE SAFETY ANALYSES

- Primary fire extinguishing means located in rooms are sufficient to extinguish possible fires in graphite management equipment (e.g. batching unit, conveyor);
- The highest effect on graphite waste will be due to graphite waste transfer truck fire;
- Personnel will be able to control truck fire in its initial stage using portable fire extinguishers;
- In case of truck fire extinguishing failure by personnel, truck fire will be put out by VFRS;
- Truck fire could last for about 45 minutes (taking into account fire extinguishing by VFRS);
- Release of Wigner energy due to truck fire during transportation of graphite waste is possible.
- In case of design fire of the truck and until arrival of VFRS, the building will be filled with smoke and the visibility will be low;
- Due to design fire of the truck in the building, the highest temperatures are expected in room 103;
- Fire resistance of building structures is sufficient to withstand the design fire of the truck;
- Due to design fire of the truck, temperature rise in the storage room 101 is possible, however the level of temperature will be such, that it will not have influence on stored F-ANP containers with radioactive waste;
- Fire water might accumulate in the building 158/2 during truck fire extinguishing

#### Recommendations and safety improvement measures

After performance of FHA of Cemented Waste Storage Facility recommendations were proposed, for instance, in order to reduce the possibility of truck fire it is necessary to inspect the waste transfer truck periodically; before entering fire area fire fighters have to evaluate radiological situation in the fire area; after fire, it is necessary to check SSCs of the building areas where fire originated and others. Appropriate safety improvement measures were implemented.

#### 2.2.5.4. Periodic review and management of changes

The review of fire safety analysis is carried out within the framework of the Periodic Safety Review every ten year. The last PSR for building 158/2 was performed in 2018 [5.43].

The last Fire Safety Analysis for building 158/2 was performed in 2020 [5.44].

The impact of modification on fire safety SSCs important to safety is analysed in planning justifying modification.

#### 2.2.5.5. Regulator's assessment and conclusions on fire safety analyses

VATESI reviewed Cemented waste Storage facility (Building 158/2) (CWSF) SAR "Final safety analysis report, Project Ignalina NPP/IPD-P18/37", which also justified fire safety of Cemented waste Storage facility, and issued an operating license in 2004. The building is made of non-combustible materials (concrete walls, floor, roof and columns), therefore, limiting the spread of fire between the fire departments of the building will be ensured and will be able to withstand the effects of fire and limit the spread of fire/smoke for the time specified in the fire safety normative documents. Fire detectors are installed in rooms where electrical or mechanical equipment is installed. The fire detection signal is transmitted to the existing fire detection central unit in the building, where staff are available 24 hours a day, therefore, the fire detection system is able to detect possible fires in time. The cementitious radioactive compound that is obtained in the cementing plant is chemically stable, radiation-stable, non-flammable, chemically and corrosively inactive, non-toxic, and the porosity corresponds to concrete hardened materials. It does not contain pyrophoric substances that could cause spontaneous combustion and/or explosion, and there are no conditions for the formation of flammable and explosive gases.

VATESI also reviewed CWSF the PSR report "Periodic safety assessment report of the liquid radioactive waste cementation complex, buildings 150, 151/154, 158/2", which was submitted in 2018

and because the report did include a detailed FHA, VATESI required that a FHA report be prepared and submitted to VATESI. SE Ignalina NPP prepared the FHA report and submitted it to VATESI in 2020. VATESI carried out an inspection at the Cemented waste Storage facility (Building 158/2) in 2020. During the inspection VATESI inspectors examined whether maintenance and comprehensive testing of safety-critical fire detection, alarm and extinguishing systems are carried out in a timely manner in Building 158, and whether a fire extinguishing plan is in place and fire drills are carried out. No violations and non-conformities with good practice were identified during this inspection.

During VATESI review of the SE Ignalina NPP provided fire safety analyses it was determined that the Cemented Waste Storage (Building 158/2) has adequate fire protection.

### **2.3. Facilities under decommissioning**

#### **2.3.1. Ignalina NPP Unit 2**

##### **2.3.1.1. Types and scope of the fire safety analyses**

On December 31, 2009, the 2nd unit of the Ignalina NPP was shut down for decommissioning. In 2022, all the fuel from the 2nd unit was transported to storage in the SNFSF-2. Systems important to safety, performing functions of radiation protection for personnel and the public, remain in operation. Additionally, work is being carried out on the 2nd unit to implement projects for the dismantling and decontamination of equipment from the 2nd unit.

The basis for Ignalina NPP Unit 2 FHA performance was “Technical specifications” of FHA of Unit 2 at Ignalina NPP, developed by Ignalina NPP.

The reasons for Ignalina NPP Unit 2 FHA performance were license requirements for Ignalina NPP Unit 2, which anticipate development of the Report on the analysis of fire safety of Unit 2 (SAR-2), the part of which according to the technical meeting minute “On the performance of fire hazard analysis of Ignalina NPP Unit 2” considered to be Ignalina NPP Unit 2 FHA.

The Ignalina NPP Unit 2 FHA work is concentrated basically on the demonstration of nuclear safety in case of fire, and therefore includes the following questions:

- Sufficient knowledge of IAEA, Republic of Lithuania normative documents and etc. (including international) concerning fire safety at Ignalina NPP;
- Scope and necessity of performance of additional measures to improve fire safety;
- Sufficiency of existing fire protection measures (considering additional measures) for the guarantee of nuclear safety at Ignalina NPP.

Ignalina NPP Unit 2 FHA is performed on the basis of Ignalina NPP Unit 1 FHA and is essentially less in the scope, but not in the essence. According to “Technical specifications” Ignalina NPP Unit 2 FHA includes selective detailed analysis of the most important (from the point of view of nuclear and fire safety) rooms and comparison with similar rooms of Ignalina NPP Unit 1, analysis and comparison of fire protection systems of Ignalina NPP Units 1 and 2, analysis of performed measures on the improvement of fire protection in Unit 2, analysis of FHA for Ignalina NPP Unit 1 recommendations for their implementation on Ignalina NPP Unit 2, and also development of new recommendations on the improvement of fire protection.

Selective rooms, the safety of which has direct influence on the Ignalina NPP Unit-2, and control of radioactive substances release into the environment, and also the most important fire hazard rooms were subjected to analysis.

## 2. FIRE SAFETY ANALYSES

The main goals of FHA for Ignalina NPP Unit 2 were:

- Determination of fire safety degree of rooms, buildings and constructions of Ignalina NPP Unit 2 at Ignalina NPP from the point of view of nuclear safety guarantee;
- Determination of protection from fire of analyzed systems, responsible for control and retention of radioactive substances in technological systems and reduction of releases into the atmosphere within fixed limits by using the most known in the world practice and analytically checked methods and criteria;
- Determination of necessary recommendations and formation of basis for arrangements on the improvement of fire protections of safety important SSCs.

The aim of Ignalina NPP Unit 2 FHA was - on the basis of Ignalina NPP Unit 1 FHA and additional selective analysis of the most important rooms, fire protection systems and implemented and recommended for implementation arrangements on the improvement of fire safety in accordance with national and international norms, give conclusion on the condition of fire protection of Ignalina NPP Unit 2 from the point of view of nuclear safety.

Fire safety analysis has six separate aims:

- Identification of safety important SSCs, considered during analysis of safety important SSCs in the present FHA project, and their location;
- Development of fire and its consequences for safety important SSCs, considered during screening and further analysis in the present FHA project;
- Identification of required fire resistance of fire barriers, considered during screening analysis in the present FHA project;
- Identification of AFA sensors type and necessary protection means, considered during screening and further analysis in the present FHA project;
- Identification of places, where additional fire separation and protection is required, especially for the general damage case, in order to guarantee, that safety important SSCs would perform their functions during and after probable fire, considered during screening and detailed analysis in the present FHA project;
- Examination, that requirements considered during screening and further analysis in the present FHA project are performed (considering the single failure principle).

According to “Technical specifications” requirements during performance of Ignalina NPP Unit 2 FHA, selective main rooms of Ignalina NPP Unit 2 with SSCs important for safety during fire, without adjacent rooms are subjected to complex detailed analysis.

In general, Ignalina NPP Unit 2 FHA work comprises of:

- Creation of rooms list, subjected to selective survey. 30 most important rooms of category 1 from blocks A2, B2, D2, G2, 20 other characteristic rooms from blocks A2, B2, D2, G2, 4 rooms of hardware FFA pumps and WFF and FFF pumps from the building. 120/2, 5 cable rooms from block D2 and 5 cable vaults from blocks A2, D2;
- Pre-survey data collection with checklists from database for Ignalina NPP Unit 2 and recording of all data to the checklists and to the new database;
- Comparison of collected data with data of similar rooms of Ignalina NPP Unit 1 and analysis of differences and detailed analysis according to Ignalina NPP Unit 1 FHA methodology of rooms, which have differences from similar rooms of Ignalina Unit 1 or not analyzed during Ignalina NPP Unit 1 FHA;

## 2. FIRE SAFETY ANALYSES

- Comparison of fire protection systems of Ignalina NPP Units 1 and 2 and assessment of fire protection adequacy;
- Analysis of performed measures on the improvement of fire protection on Ignalina NPP Unit 2;
- FHA Ignalina NPP Unit 1 recommendations analysis for their implementation on Ignalina NPP Unit 2 and development of new recommendations for fire safety improvement;
- Conclusions on the condition of fire protection of Ignalina NPP Unit 2 from the point of nuclear safety.

FHA of Ignalina NPP Unit 2 in general is performed by the state of January 1-st, 2002.

The building A-2, Reactor Housing No. 2 of building 101/2 with a 3-stack metal vent stack, along with the buildings B-2, V-2, D-2, and G-2, is part of the main structure of the 2nd unit of the Ignalina NPP building 101/2. It is located 400 meters from the shore of Lake Druksiai, serving as a natural water reservoir used for cooling the station's equipment. The building is situated in the central part of the main structure, between rows D-III, in axes 18/19-33/34.

Building A-2 is a multi-story building with a basement, rectangular in plan with dimensions of 90x84 meters, featuring a protruding part in axes 24-28 and a brick extension in axes 23-24. The relative elevation of the top of the building is +62.6 meters. In the underground part of the building, rooms are located at elevations of -3.60 meters, -7.20 meters, and between rows II-T at an elevation of -12.00 meters. In the above-ground part, rooms are located at elevations: ±0.00 meters, +6.00 meters (+4.20 meters, +7.20 meters), +10.80 meters (+12.00 meters), +16.80 meters, +20.40 meters, +25.20 meters, +28.80 meters, +32.40 meters, +38.40 meters (+39.60 meters), +42.00 meters (+43.20 meters, +45.60 meters), +48.00 meters (+49.20 meters), +52.80 meters (+54.00 meters), +57.60 meters, and +60.20 meters. The building is constructed in a precast-monolithic variant.

The foundations consist of a solid reinforced concrete slab with a thickness of 1500 mm, made of heavy hydro-technical concrete of grade M300 in terms of strength. The depth of the slab is 9.00 meters, and between rows II-T, it is 13.80 meters. The waterproofing under the slab is made of hot bitumen-rubber mastic with continuous reinforcement using two layers of glass fabric.

The reinforced concrete structures of the underground part of the building are made of heavy hydro-technical concrete of grade M300 in terms of strength. The waterproofing of the external walls of the underground part is made of hot bitumen-rubber mastic with continuous reinforcement using one layer of glass fabric.

The reinforced concrete structures of the above-ground part of the building are made of heavy ordinary concrete of grade M300. Monolithic walls and ceilings of the "hot" chamber are made of highly dense concrete of grade M300 in terms of strength.

Reinforced concrete walls and columns serve as rigid supports for the multi-circuit base plate of the bottom, function as wall-beams in the spatial frame system, bear loads from ceilings, and provide biological protection.

Ceilings with a thickness of more than 1000 mm, spans of more than 7 meters, and those with a large number of openings and embedded parts are made of monolithic reinforced concrete. Ceilings with a thickness of up to 1000 mm and spans of up to 7 meters are made of precast-monolithic ribbed slabs and monolithic reinforced concrete.

Reinforcement of monolithic reinforced concrete structures is done with spatial formwork blocks with non-removable metal formwork and with armoblocks using non-removable concrete formwork. The reinforcement of structures in rooms with high accident overpressure is made of rigid reinforcement made of rolled profiles.

## 2. FIRE SAFETY ANALYSES

Reinforced concrete walls and ceilings of the rooms in the localization tower, as well as in the sturdy boxes and fuel cassette holding pools, are lined on the inside with carbon steel or stainless steel. Internal enclosing reinforced concrete surfaces of rooms are protected by special insulation with ventilated air gaps.

The strength and stability of the precast-monolithic structural frame part of the building in the longitudinal direction are provided by horizontal precast reinforced concrete beams and vertical metal ties on columns. In the transverse direction, it is ensured by frames formed by columns and girders and connected to the monolithic mass. The joints of the frame elements are rigid. The ceilings are made of ribbed precast reinforced concrete slabs.

Internal partitions with a thickness of 120-140 mm are made of precast concrete, partly brick. The main stairs are made of precast concrete elements. Service platforms in technical rooms are metallic.

External enclosing structures of walls are made of ceramsite concrete panels with a thickness of 300 mm, faced with a textured layer. External walls of the "clean" entrance in axes 23-24, between rows X-III are made of bricks. The gates are metallic, swing, double-leaf.

The roof is flat, combined, non-ventilated with internal drainage made of four layers of roofing felt on bituminous mastic over mineral wool insulation. During the operation of the unit, a roof film covering made of "Wolfin" material is applied to the roofing felt carpet. For lightning protection, a lightning-receiving strip made of steel sheet 40x4 mm is installed on the roof, connected around the perimeter of the building to the grounding circuit.

On the roof, there is a 3-stack metal ventilation stack. It consists of 3 gas-discharge metal ducts, the bases of which are located at an elevation of +62.60 meters. One stack is vertical with a height of 96.4 meters from an elevation of +62.60 meters to +159.00 meters. The other two stacks approach it at an angle up to an elevation of +122.00 meters and, forming a bend, go vertically up to an elevation of +152.40 meters. The diameter of the stacks is 4.8 meters.

The FHA was conducted to determine the condition of the "defense in depth" fire protection and its capability to ensure that safety important SSCs can perform their functions during a fire.

The FHA of Unit 2 of the Ignalina NPP was conducted based on the results of the FHA of Unit 1, which involved analyzing and comparing the fire protection systems and measures to improve the fire safety of both Unit 1 and Unit 2, as well as selectively analyzing and comparing 68 rooms.

### 2.3.1.2. Key assumptions and methodologies

Ignalina NPP Unit 2 FHA methodology is based on Ignalina NPP Unit 1 FHA methodology. Considering, that during Unit 1 FHA analysis of the most important safety systems and sufficiently big amount of rooms (in the whole 2131 rooms) was performed, the main attention of present Ignalina NPP Unit 2 FHA is concentrated on the comparative analysis of characteristics of Ignalina NPP Unit 2, detailed analysis of the most typical rooms and development of specific recommendations for fire safety improvement.

Ignalina NPP Unit 1 FHA methodology in details is as follows: objectives and main phases, main assumptions and limitations, room categorization, pre-survey data collection and during surveys, screening algorithms, preliminary and detailed analysis methodologies.

Ignalina NPP Unit 2 FHA was performed with consideration of international and national norms, fire safety standards and rules at SE Ignalina NPP. The work was mainly concentrated on the demonstration of nuclear safety in case of fire.

Basically, the requirements of normative documents of IAEA and the documents of the Republic of Lithuania were considered, giving the priority to the latter. During fire safety analysis at Ignalina NPP,

## 2. FIRE SAFETY ANALYSES

the methodological experience of USA Ministry of Energy with the similar NPPs, operating with RBMK reactors was also considered.

According to “IAEA Safety Guide” basic requirements for compliance with nuclear safety criteria at Ignalina NPP in case of fire are as follows:

- Prevention of radioactive releases above prescribed limits.

The basic international fire safety requirements for analyzed rooms are following:

- The minimum 60 min fire resistance of all fire barriers;
- Availability of Automatic fire detection and alarm system;
- Availability of AFF and manual fire fighting means for category 1 and 2 rooms.

### **Objectives and main methodology steps**

The main objective of Ignalina NPP Unit 2 FHA to documental prove, that the existing fire protection measures guarantee Ignalina NPP Unit 2 nuclear safety.

Therefore the main Ignalina NPP Unit 2 FHA steps were the following:

- Development of rooms list for selective detailed analysis: on the basis of Unit 1 FHA during safety paths analysis, the list of the most typical rooms, subjected to the check-up survey and data collection for detailed analysis, is created for provision of safety functions safety important SSCs;
- Preliminary data collection and surveys: on the basis of Ignalina NPP Unit 1 FHA database the data about rooms and components is collected, which are subjected to detailed analysis, and which is checked during surveys. All the data was recorded into the corrected database;
- Comparative analysis and screening: collected data for typical rooms of Ignalina NPP Unit 2 was compared with the data of analogous rooms of Ignalina NPP Unit 1. According to developed algorithms during Ignalina NPP Unit 1 FHA the screening was performed. The not screened out rooms were the object for more detailed analysis;
- Detailed analysis: for analysis of not screened out rooms improved methods were used, proposed by western experts during Ignalina NPP Unit 1 FHA. Additional necessary data was collected, adequate fire scenarios were described, assessments of fire engineering and model calculations for the final identification of fire influence and spread were performed;
- Comparative analysis of fire protection systems of Ignalina NPP Units 1 and 2: the comparison of fire protection systems of both Units and its adequacy assessment was performed;
- Analysis of performed measures for fire protection improvement in Ignalina NPP Unit 2;
- Recommendations for fire protection improvement and summarization of results: according to analysis results new recommendations are developed for fire protection improvement. Analysis of FHA Ignalina NPP Unit 1 recommendations was performed for their implementation in Ignalina NPP Unit 2. Conclusion is drawn on the condition of fire protection of Ignalina NPP Unit 2 from the point of nuclear safety.

### **Main assumptions and limitations**

Methodology of FHA performance is based on the given below assumptions, requirements and limitations. They are in correspondence with existing code of rules, standards and norms.

1. Only one fire is possible in the buildings servicing Unit, which can occur at any fire hazardous section. Fire growth to the adjacent fire sections is not considered if it is proved that fire barriers of the given sections taking into account other fire means preventing fire spread. Thus, fires occurring at many places at the same time for some common reason (explosions etc.) are not considered.

NATIONAL ASSESSMENT REPORT OF THE REPUBLIC OF LITHUANIA	Page 135 of 163
2. FIRE SAFETY ANALYSES	

2. For Ignalina NPP where there are two Units, simultaneous ignition at the different Units is not taken into account, however, if analyzed room contain equipment for both Units it shall be reflected in FHA.
3. Together with the fire, a single failure can occur in Fire Protection System or a failure of one safety important system component.

### 2.3.1.3. Fire phenomena analyses: overview of models, data and consequences. Main results.

According to Technical Specification the following tasks were performed during Ignalina NPP Unit 2 FHA:

- General list of rooms, subjected to survey during Ignalina NPP Unit 2 FHA , was compiled;
- Survey of rooms was performed, collected data were recorded into the database and Unit 1 FHA database was adjusted to the requirements of Ignalina NPP Unit 2 FHA ;
- Comparison of collected data from Unit 2 with data from similar rooms in Unit 1 was performed. In case of deviations, which cause decrease in fire protection, detailed analysis of rooms was performed;
- Comparison of fire protection systems of Ignalina NPP Units 1 and 2, and assessment of fire protection adequacy was performed;
- Analysis of implemented fire protection improvement measures on Ignalina NPP Unit 2;
- Recommendations were generated from detailed analysis results;

#### Surveys of the rooms

Data were collected for performance of comparison and detailed analysis for 64 rooms during surveys of the rooms at Ignalina NPP Unit 2. The database management system “UGNIS-2” was used to facilitate recording, organization, sorting, retrieval and calculations of data collected. The database software and data records were verified according to the QA system requirements. The data from database were used for compilation of general list of rooms subjected to Ignalina NPP Unit 2 FHA, performance of detailed analysis of the rooms and preparation of reports.

#### Comparison of survey data and detailed analysis

64 most important, concerning fire hazard, category 1 rooms, category/group 2 and 3 rooms were analyzed in details. Detailed analysis results are presented in Table 1.

Basic recommendations, received after detailed analysis of above mentioned category/group rooms:

- Install AFA (4 rooms);
- Install manual fire fighting means (4 rooms);
- Install doors with fire resistance not less than 60 min. (1 room);
- Replace door (or perform fire modeling in adjacent rooms) (1 room);
- Seal up the door (2 rooms);
- Seal penetrations (1 room);
- Install drainage system in the safety important cable channels, which are under floor level (2 rooms).

#### Assessment of fire protection adequacy

System produces sufficient amount of extinguishing agent with security factor equal to three.

There is a possibility of connecting fire cars to headers of Unit 1 and Unit 2 and also joining headers of Units 1 and 2.

Foam solution source is not big enough to provide Ignalina NPP Unit 2 with extinguishing agent during one hour. But, considering all fire fighting alternatives, national criteria of one hour is fulfilled.

## 2. FIRE SAFETY ANALYSES

Maximum extinguishing agent flow to the biggest extinguishing system can be provided simultaneously with provision of manual fire fighting equipment with water or foam solution.

WFF and FFF systems of Ignalina NPP Unit 2 have three pumps each: one –main, others – redundant. All pumps are located in the same room.

System is supplied by redundant power supply from accumulators and connection with the ordinary power system.

All circuits of fire alarm are supplied with direct current.

To maintain the effectiveness of operation of automatic fire protection, technical maintenance, control and testing of AFF systems are performed in accordance to Operation instruction and Technical maintenance regulations of AFF systems.

Analysis of the above presented material allows to draw a conclusion, that redundancy of pumps, control circuits of pumps and power supply, ring principle of distributing headers location, and also permanently performed technical maintenance of equipment shows the acceptable reliability of AFF system elements. On the whole, fire protection Ignalina NPP Unit 2 complies with requirements of Republic of Lithuania.

#### **Analysis of performed measures for fire protection improvement**

Fire safety improvement at Ignalina NPP Unit 2 was always given big attention from the plant administration, as well as from supervising bodies.

Main measures were concerned with fire resistance improvement of separate structural elements (building constructions, doors, air ducts, valves, gates, cables), with installment of automatic fire alarm in the most important SSCs rooms, with fire safety improvement in footway corridors, in staircases, cable tunnels and shafts.

The most important of them are:

- In safety important SSCs rooms fire proof Swedish doors are installed (fire resistance 1,5-2 hours), total number of doors is about 980;
- Load bearing metal constructions of turbine halls columns are coated by fire proof mixtures with fire resistance 1,5 hours; load bearing metal constructions of turbine halls girders are coated by fire proof mixtures with fire resistance 0,5 hours; load bearing metal constructions of MFWP platforms are coated by fire proof mixtures with fire resistance 0,75 hours;
- On air ducts of safety important cable rooms, fire rated valves are replaced with new Swedish and English valves (fire resistance 1,5 hours), more than 100 pieces; performed protection of transient air ducts with materials, which fire resistance is 1,5 hours;
- In the systems of automatic water and foam fire fighting group action valves are replaced with Swedish electric gates, total number on the plant is 322 pieces;
- In turbine halls, in the pump rooms 120/2 and rooms of safety important systems automatic fire alarm is mounted;
- Cables in safety important cable rooms are coated by fire proof paste, cable penetrations are sealed by fire proof materials of German origin;
- Cable lines of different safety important systems are separated by building constructions with fire resistance 1,5 hours; on cable lines and racks each 14 m fire coatings are situated with fire resistance 0,75 hours;
- Long footway corridors are separated by antismoke doors on compartments 60 m long, cable tunnels are separated on compartments 72 m long;



## 2. FIRE SAFETY ANALYSES

- In safety important systems rooms and long footway corridors plastic floor linings are replaced with non-combustible linings.

All measures are developed on the assumption of international requirements of IAEA and do not contradict to national norms of Republic of Lithuania.

**Ignalina NPP Unit 2 FHA recommendations**

Recommendations for fire safety improvement of Unit 2 rooms at Ignalina NPP, subjected to Unit 2 FHA, relatively were separated into 3 groups:

1. Recommendations generated from detailed analysis results of the most important rooms at Unit 2 (Unit 2 FHA );
2. Recommendations, accepted after analysis of recommendations, generated from FHA phase 1 at Unit 1 (Unit 1 FHA/1);
3. Recommendations for rooms with safety important SSCs, accepted after analysis of recommendations, generated from FHA phase 2 at Unit 1 (FHA1/2).

Ignalina NPP Unit 2 FHA recommendations generated from detailed analysis results are proposed in the first place since they are based on more precise initial information, received after surveys of Unit 2 rooms at Ignalina NPP and flexible detailed analysis methodology.

On the basis that no substantial differences were determined between Units 1 and 2 during analysis of survey results of the most important rooms with safety important components and analysis of fire protection systems at Unit 2, recommendations generated during FHA phases 1 and 2 for Ignalina NPP Unit 1 are also accepted on Unit 2 after their analysis in relation to assumptions and limitations made.

As a result, 86 recommendations were generated for all three groups, including:

- 9 recommendations for category/group 1 rooms;
- 12 recommendations for category/group 2 rooms;
- 65 recommendations for category/group 3 rooms.

Appropriate safety improvement measures to address above mentioned recommendations were prepared and implemented.

**Conclusions**

After comparison of fire protection systems of Ignalina NPP Units 1 and 2, analysis of recommendations of Ignalina NPP Unit 1 for their implementation on Ignalina NPP Unit 2 and detailed analysis of 64 most important rooms with safety important components, the following conclusions may be drawn:

1. Defense in depth of Unit 2 at Ignalina NPP performs its main functions for prevention, detection, liquidation and reduction of fire consequences as it is shown during fire hazard analysis of Ignalina NPP Unit 2 (FHA2). It ensures acceptable fire safety for safety related systems, performing its main function (control and prevention of radioactive releases above prescribed limits into the environment) in case of fire, determined by fulfillment of the main fire safety requirements (minimum fire resistance of fire barriers, presence of AFA and AFF or manual fire fighting means).
2. Analysis of measures performed for fire protection improvement at Ignalina NPP showed, that all recommendations for Unit 1 were implemented on Unit 2 at the same time. Implementations of such measures on Unit 2 at Ignalina NPP indicate about substantial improvement of fire safety on the Unit 2 in the whole, as well as from the point of nuclear safety.

## 2. FIRE SAFETY ANALYSES

3. The recommendations for decreasing of fire hazard were given for category/group 1, 2 and 3 rooms generated from detailed analysis results which are of importance and recommendations given after analysis of recommendations for Unit 1 were implemented in Unit 2.

All the recommendations provided in the Ignalina NPP Unit 2 FHA were implemented in the Unit 2 of the Ignalina NPP.

A significant volume of hot work associated with equipment dismantling is being carried out at the Ignalina NPP Unit 2. The requirements for the safe execution of hot work are established in General Instruction of Fire Safety.

The process of dismantling and decontamination of equipment at the Ignalina NPP Unit 2 is performed through separate projects, which include a mandatory section on "Fire Safety" specifying the necessary organizational and technical measures. SAR are developed for the equipment dismantling and decontamination projects at the Ignalina NPP Unit 2. The work is only carried out after the projects and safety reports are approved by VATESI.

The conclusions regarding the analysis of fire hazard for safety important SSCs during the execution of individual projects for dismantling and deactivation of decommissioned equipment are substantiated in the respective SARs:

1. The execution of the work will not have an impact on the separation of Ignalina NPP Unit 2 into fire compartments and sub-compartments.
2. The conditions for preventing the spread of fire between building compartments and the protection of safety important SSCs will be maintained during the execution of the work by the specified fire barriers.
3. During the execution of the work, strict control is maintained to ensure the integrity and fire resistance of the fire barriers, meaning that their fire resistance limits and the impact of fire on safety important SSCs will not be compromised.
4. During the execution of the work, all passive and active fire extinguishing system elements located in Unit 2 remain fully operational, ensuring their integrity and functionality. This, in turn, guarantees the protection of safety important SSCs.
5. Conducting work through the work permit system by qualified personnel, using certified equipment, adhering to the required fire safety measures at workstations, ensures a sufficient level of fire safety during welding and other hot work operations.
6. The specified arrival time of the VFRS at the fire scene, as outlined in the project, ensures that safety important SSCs have enough time to perform their protective functions during and after the fire has been extinguished
7. The potential impact on the loss of functionality of safety important SSCs due to false activations of automatic fire suppression systems is eliminated.
8. The impact of secondary fire effects on the loss of functionality of safety important SSCs is eliminated.
9. Adequacy and suitability of fire safety measures are ensured for fire detection, warning, and suppression systems, which are safety important SSCs, in case of their malfunction due to common reasons. This ensures that they can perform their protective functions as outlined in the project during and after a fire.

#### 2.3.1.4. Periodic review and management of changes

The review of fire safety analysis is carried out within the framework of the Periodic Safety Review every ten year. The last Periodic Safety Review for Ignalina NPP Unit 2 was performed in 2010

## 2. FIRE SAFETY ANALYSES

[5.48]. At the moment, a periodic safety assessment of the Ignalina NPP Unit 2 is being conducted, combined with the SAR of the decommissioning of the Ignalina NPP.

The last Fire Safety Analysis for building Ignalina NPP Unit 2 was performed in 2002 [5.49].

The impact of modification on fire safety SSCs important to safety is analysed in planning justifying modification.

In accordance with the Final Decommissioning Plan and the Decommissioning Schedule of the Ignalina NPP, the Ignalina NPP carries out a series of separate projects for dismantling and deactivating decommissioned equipment. Confirmation of compliance with the decisions and technologies chosen in the Technological Project, the objectives of the decommissioning and deactivation of equipment, initial treatment and waste management, and the regulatory and technical safety requirements is provided in the respective Safety Analysis Reports [5.50, 5.51, 5.52, 5.53].

#### 2.3.1.5. Regulator's assessment and conclusions on fire safety analyses

Together with the technical support organizations, VATESI reviewed Ignalina NPP Unit 2 SAR "Safety Analysis Report for Ignalina Unit 2" and FHA for Ignalina NPP unit 2, in which was justified fire safety of Ignalina NPP Unit 2, and issued an operating license in 2004. The detail FHA for Ignalina NPP unit 2 was performed using FHA for unit 1. The FHA for Ignalina NPP unit 2 was conducted to determine the condition of the "defense in depth" fire protection and its capability to ensure that safety important SSCs can perform their functions during a fire conducted to determine the condition of the "defense in depth" fire protection and its capability to ensure that SSCs can perform their functions during a fire.

Currently Ignalina NPP unit 2 is under decommissioning. The process of dismantling and decontamination of equipment at the Ignalina NPP unit 2 is has been performed through separate projects, which include a mandatory section on "Fire Safety" specifying the necessary organizational and technical measures. These works is only carried out after the technical projects and safety reports are approved by VATESI. VATESI is currently evaluating the PSR report prepared and submitted by SE Ignalina NPP for decommissioning Ignalina NPP unit 2, which also includes the justification assessment for fire safety.

After the final shutdown of Ignalina NPP Unit 2 in 2010, over the past years, the fire load and fire hazards in Ignalina NPP Unit 2 have been continuously decreasing due to the dismantled combustible equipment. VATESI at Ignalina NPP Unit 2 is paying more attention to the supervision of decommissioning activities involving hot works and explosive gas cylinders, as well as the temporary storage of flammable radioactive waste.

VATESI carries out fire safety inspections at Ignalina NPP Unit 2 every year. During the inspections, deficiencies were identified due to explosive gases (gas cylinders used for dismantling equipment) and storage of flammable materials in places not intended for that purpose. In order to ensure that such shortcomings do not recur, VATESI supplemented fire safety requirements that when there are temporary additional fire loads in Ignalina NPP Unit 2, the danger posed by them must be assessed and justified, and all possible measures must be taken to prevent fires. It was also demanded that an accounting procedure for explosive gas cylinders used during equipment dismantling works shall be prepared, in which employees responsible for the safe use, storage, transportation and accounting of explosive gas cylinders must be identified. VATESI ten year ago also found, that the training of employees, who are assigned to extinguish fires using autonomous compressed air respiratory protective devices is not ensured. Compressed air respiratory protective devices were not properly

## 2. FIRE SAFETY ANALYSES

maintained, and a sufficient amount of them was not ensured. At the request of VATESI, all these deficiencies were eliminated.

In accordance with VATESI Nuclear Safety Requirements BSR-1.4.4-2019 “Use of Operating Experience in the Field of Nuclear Energy” all safety significant events occurred at Ignalina NPP NIs as well as fire related events shall be analyzed, their direct causes and root causes shall be identified, the impact on safety and potential consequences shall be assessed and the corrective actions shall be established. SE Ignalina NPP have report to VATESI verbally about all safety significant events as soon as possible, but not later than within 1 hour with a subsequent written notification by fax within 24 hours. Event analysis report shall be prepared and presented to VATESI within 30 days.

VATESI was informed about unusual event „Ignition of the film covering containers with very low level radioactive waste, due to improper organization hot works“ occurred in 01/04/2022 at Ignalina NPP Unit 2 at the turbine hall. As stated in BSR-1.4.4-2019 Ignalina NPP prepared an event analysis report of this event, which indicates the direct and main causes of the event, prepared and implemented corrective actions, and submitted it to VATESI for approval. Event analysis report was analyzed in the meeting of VATESI permanent Commission of Unusual Events and Operating Experience (Commission). The communication with Ignalina NPP was initiated by VATESI in order to clarify additional event circumstances and identify correct the root cause and corrective measures. In response to this event, VATESI carried out an unplanned inspection in the turbine hall of the Ignalina NPP Unit 2. During the inspection violations were identified and the mandatory requirement to eliminate identified violations were issued by the Head of VATESI. In order to implement the mandatory requirement, SE Ignalina NPP prepared and agreed with VATESI a plan of measures to prevent similar violations in future and implemented them. All measures of the plan were implemented by submitting the documents justifying the implementation of the measures to VATESI, which confirmed their acceptability.

VATESI systematically performs review, screening and analysis of information on fire related events available through IAEA International Reporting System for Operating Experience (IRS), Fuel Incident Notification and Analysis System (FINAS), information on events gained through Clearinghouse website, NRC website and other available sources. Fire safety related events are selected and analyzed during the meetings of Commission with a purpose to identify safety related issues, adopt the lessons learned in order to avoid the reoccurrences of events and for improve the regulatory requirements. During the period 2020-2022 VATESI prepare recommendations to SE Ignalina NPP to review FINAS events reports No. 229 “Possible loss of confinement following a gas fire-suppression system activation” and 293 "Fire in a decontamination room", IRS events reports No. 8961 „Pressure surge in water spray leading fire system leading to reactor shutdown“, and No. 8975 „Station service transformer failure resulting in fire and loss of class IV power“. A few lessons learned from these events and issues related with the safety of fire protection was included in to the personnel training material of SE Ignalina NPP.

Three OSART missions were carried out at Ignalina AE Unit 2. The first mission took place in 1995, second – in 1997, and the third – in 2006. During these OSART missions, fire safety assessments were also carried out, during which recommendations were made (regarding storage areas for flammable and explosive materials; additional measures to ensure the safe work of firefighters during fires, etc.). Also fire safety was assessed at Ignalina NPP Unit 2 during the WANO mission in 2002. Following these missions, SE Ignalina NPP prepared the safety improvement action plans, which included measures related to fire safety. Taking into account the received recommendations, SE

Ignalina NPP prepared plans of safety improvement measures and informed VATESI about their implementation.

VATESI concluded that the fire safety analyses of Ignalina NPP Unit 2 were carried out properly.

## 2.4. Licensee's experience of fire safety analyses

### 2.4.1. OSART mission

At the request of the Government of Lithuania, an IAEA Operational Safety Review Team (OSART) of international experts visited Ignalina NPP in 2006, follow-up – in 2008. The purpose of the mission was to review operating practices in the areas of management organization and administration; training and qualification; operations; maintenance; technical support; operating experience feedback; radiation protection; chemistry; and emergency planning and preparedness. In addition, an exchange of technical experience and knowledge took place between the experts and their plant counterparts on how the common goal of excellence in operational safety could be further pursued.

During the mission the team also focused on areas for improvement. The experts provided recommendations and suggestions among which the most significant are as follow:

- Emergency response organization should develop pragmatic actions to enhance the efficiency of assembling points, the gathering, counting and protection of the workers, and improving drills and exercises;
- Fire response needs in the same manner clarification and training to be understood by all staff.

The SE Ignalina NPP management paid high attention to the recommendations and suggestions in the field of fire protection. A working group was established at the Ignalina NPP, who advised the administration on specific ways to improve this field, namely, improvement of procedures for fire detection and personnel evacuation, counting and training. In 2007 several fire protection exercises were conducted with personnel evacuation from Ignalina NPP buildings.

The team noticed that fire response process and procedures are in place however they appear complicated to implement and understand. Plant staff and contractors interviewed did not have clear notion on what to do in the event of a fire. The team noticed that no full-scale site fire drills have been completed and by consequence no lessons learnt were carried out. The team has made a recommendation in this area.

The fire protection system in place is adequate, however the general house keeping for the main firewater tank and the associated fire pumps need more attention.

Portable fire fighting equipment is adequately maintained on site although the team found a couple of locations where redundant fire extinguishers were missing.

Maintenance of fire barriers is adequate; bundles of more than 12 electrical cables are coated in a fire-retardant coating; on one hand this is good however the coating makes it impossible to check for cable degradation and ageing. The team also found some inconsistency in emergency lighting: some are marked as emergency lighting and are on (in cable race) and some are off (e.g. on the reactor link corridor); all emergency lighting should be, by procedure, permanently on. The team encourages the site to address these non compliances with rules.

Different departments carry out surveillance and testing of fire fighting protection/detection systems. There is a central data base which shows the fire valve and equipment configuration.

## 2. FIRE SAFETY ANALYSES

When promoted, staff has to pass a technical examination relative to the new position. In addition all staff has to pass fire safety examination prior to final authorization to perform task for the new position.

In complement to the internal fire organization, the site has a fully equipped fire brigade station situated just outside the site boundary, which is manned 24 hours a day. The fire station and engines are well maintained.

The team noted that the VFRS do not have a access control procedure to record the time that a fire fighters puts on breathing apparatus and enter the fire zone, or records the 'expected time out' (a calculation of time, based on the amount of air that he had going into the fire zone). Apparently this is not a national regulatory requirement. The team encourages the VFRS to develop a breathing apparatus board to be used at the fire access control point. As example of improvement, the board could indicate at minimum the name of team member entering the fire zone, the bottle pressure at the time of entry, the expected time out, the description/purpose for entry, and the backup team members.

The OSART mission enabled to receive the independent and objective evaluation of the Ignalina NPP activity as well in the field of fire safety. Recommendations and suggestions provided by the OSART team have been thoroughly analyzed and consequently corrective measures have been developed.

The development of corrective measures encompassed not only consideration of specific suggestions or recommendations provided by the OSART team, but it also included the comprehensive analysis of both the revealed issues and the courses conditioning their origination. The results of the corrective measures enable to draw the conclusion regarding the maximum possible scope of revealed issues and elimination of their courses.

In order to implement the recommendation provided by the experts of the OSART Team regarding re-evaluation of the fire response procedure and leading out of personnel, besides other organizational corrective measures two new additional dedicated emergency telephone communication channels (for reception and transmission of information related to fire and personnel evacuation) have been activated. Changes into the action plan of the VFRS regarding evacuation measures in case of fire extinguishing have been as well developed and introduced, checklists for all Ignalina NPP personnel and contractors regarding actions in case of a fire and accident have been developed which included entry of personal data of each worker.

Recommendations and suggestions provided by the OSART Team in the field of operations are considered to be implemented. Nevertheless, SE Ignalina NPP will continue improving activities in the field of operations by applying own and industrial operational experience as well as assistance of international organizations.

#### 2.4.2. *WANO mission*

The overall goal of the partner assessment is to provide support to the Ignalina NPP in achieving the highest operational performance. Areas for improvement are based not on compliance with minimum standards and regulations but on examples of best global practices and are not indicative of unsatisfactory performance at the assessed NPP.

The purpose of the assessment was to evaluate the current state of areas for improvements and the effectiveness of corrective measures developed by the Ignalina NPP following the partner assessment conducted in August 2002, as well as to assess the efforts aimed at enhancing the fire safety and quality of the Ignalina NPP.

## 2. FIRE SAFETY ANALYSES

At the invitation of the Ignalina NPP, a team of experts consisting of professional nuclear power plant personnel conducted a follow-up partner assessment at the Ignalina NPP in 2007.

As a result of the WANO partner assessment, corrective measures were developed, and their implementation was verified during a follow-up visit by the WANO experts.

- "Instruction on the Interaction of Emergency Response Personnel with the Fire and Rescue Service for the Protection of Visaginas City and the Ignalina Nuclear Power Plant in Extinguishing Fires in the Equipment of Structural Units of the Ignalina NPP" has been developed.
- "Procedure for Interaction between the Emergency Preparedness Organization and State Institutions in the Event of a 'Common' Emergency at the Ignalina NPP" has been developed.
- "Instructions for Extinguishing Fires in the Electrical Installations of the Ignalina NPP" have been developed.
- The ability to make calls from DECT mini-cell phones to the VFRS phones has been organized.
- During drills and in real situations, records of permissions for PSS units are made by the personnel in the "Firefighting Permit" cards.
- Operational firefighting cards have been revised.
- According to the developed scenario, evacuation measures were carried out during the comprehensive exercises of the emergency preparedness organization.

During the assessment, positive practices were noted:

- Ignalina NPP Unit 2 along evacuation routes (corridors, stairwells, passages, galleries) have been additionally equipped with fluorescent material strips (embedded in the flooring) alongside evacuation signs. These strips have arrows indicating exit directions and glow in conditions of complete artificial lighting blackout. Implementing this measure enhances the safety of Ignalina NPP personnel during forced evacuations in conditions of complete power outage.
- Smoking areas have been organized on the industrial site near Ignalina NPP buildings and structures. These areas are constructed using transparent protective structures with overhead coverings to protect against atmospheric precipitation. All smoking areas are equipped with bins, benches, visual information about the hazards of smoking, and instructional information on fire safety. Implementing this measure enhances the fire safety level of the Ignalina NPP.

## 2.5. Regulator's assessment and conclusions on fire safety analyses

Following the completion of the construction of all the NIs specified in this NAR, the commissions of the NIs acceptance were formed, which included representatives of VATESI and Fire and Rescue Department under the Ministry of Interior. These commissions checked NIs compliance with their design documentation (including the fire safety part of the design documentation) and when all identified deficiencies were eliminated, the commissions issued acts confirming the completion of the construction of these NIs. Fire safety adequacy at Ignalina NPP NIs is also achieved by Integrated Management System (IMS) and Safety Culture. According to IMS, a fire safety management process is implemented to assure fire safety at NIs taking into account organizational and technical measures:

- storing of inflammable material amounts;
- temporary fire loads;
- provision of safe hot works;

## 2. FIRE SAFETY ANALYSES

- preventing of inflammable package bringing into specific areas;
- work briefing to personnel on fire safety;
- personnel training;
- actions in case of fire;
- active interaction with the top managers of Firefighting brigade to solve fire safety issues.

VATESI concluded that the fire safety analyses of all NIs, evaluated in this NAR, were carried out properly. However, it's necessary to emphasize that for dismantling activities different types of hot works mainly are used and those activities are performed on different places at the same time, planning and implementing of decommissioning projects requires an additional resource for properly fire safety (hazards) analysis and surveillance in comparison with normal operation of NIs. SE Ignalina NPP during planning and implementing of decommissioning projects ensure all required resources for fire safety.



### **3. Fire Protection Concept and Its Implementation**

For the fire safety of SE Ignalina NPP, a comprehensive set of fire safety measures has been implemented. These measures encompass both administrative and technical measures. Administrative fire safety measures are general practices and procedures applied by SE Ignalina NPP as a company and are not specific to any particular nuclear facility or specific activity.

Since a unified approach to the fire protection concept and its implementation is applied at the SE Ignalina NPP, this section of the report is applicable to all NIs of the Ignalina NPP, including the selected nuclear installations for assessment.

More detailed information on the fire protection concept and its implementation is provided in the SARs for the respective NIs [5.32, 5.33, 5.34, 5.36, 5.38, 5.39, 5.41, 5.43, 5.45, 5.47, 5.48].

#### **3.1. Fire prevention**

##### **3.1.1. *Design considerations and prevention means***

The design solution involves the division of buildings and structures into fire compartments and sectors. Rooms of different categories in terms of explosion and fire hazards are separated from each other using enclosing structures or fire barriers with specified fire resistance class and their fire endurance limit. Separation of NIs into fire compartments and sectors has not changed since the beginning of their operation.

##### **3.1.2. *Overview of arrangements for management and control of fire load and ignition sources***

The categories of rooms based on explosion and fire hazards are specified in the lists of production and storage rooms of the respective departments of the Ignalina NPP. Additionally, the lists include the room numbers, their designated use area, fire extinguishing agents used with their quantities specified, individuals responsible for fire safety, and their telephone numbers. The fire load in rooms with safety important SSCs is continuously monitored.

The commissioning and subsequent operation of new equipment for dismantling and deactivation at the Ignalina NPP nuclear installations, due to minor changes from a fire safety perspective, do not entail changes to the categories of rooms based on explosion and fire hazards.

##### **3.1.3. *Licensee's experience of the implementation of the fire prevention***

In accordance with the requirements of legal and regulatory documents on fire safety, the state fire supervision and firefighting operations at the premises of Ignalina NPP are carried out by the units of the VFRS. All fires at Ignalina NPP, including false activations of active fire protection systems, are analyzed by commissions. Reports are sent to the VFRS and VATESI, and the implementation of corrective measures is monitored.

##### **3.1.4. *Regulator's assessment of the fire prevention***

The requirements of VATESI stipulate that NIs must be designed in such a way as to reduce the probability of fire, and taking into account the flammability and explosive properties of radioactive waste in storage, safe storage solutions for radioactive waste must be provided. VATESI carried out the review of all NIs fire prevention mentioned in the report, not only during the assessment of their design documentation, but also carries out continuous supervision of fire prevention. VATESI on site

## 3. FIRE PROTECTION CONCEPT AND ITS IMPLEMENTATION

inspectors regularly supervise whether fire prevention measures are applied, including specific needs arising from the operation of dangerous equipment and processes (flammable liquids, pyrophoric substances, temporary fire loads, etc.). During licensing, VATESI constantly checks the fire safety assurance documents (procedures, regulations, instructions, etc.) of the quality management of SE Ignalina NPP, which are intended to ensure fire prevention. These documents of the SE Ignalina NPP set the requirements for the control of fire loads, hot work and ignition sources, and describe how to safely carry out hot work and safely use ignition sources.

### 3.2. Active fire protection

#### 3.2.1. Fire detection and alarm provisions

To detect a fire at its early stage, all Ignalina NPP NIs fire hazardous rooms (equipment) are equipped with a fire detection and alarm system (heat and smoke detectors, manual call points) as specified per the design documentation.

The "Fire" and "Fault" alarms from Ignalina NPP NIs are relayed to the control room in Ignalina NPP Units 2 with 24/7 monitoring.

Technical maintenance of fire detection systems is carried out by the personnel of the Ignalina NPP in accordance with the respective operating instructions. All instances of non-compliance identified during operation, technical supervision (maintenance), and inspections are documented and rectified.

Monthly checks of the fire alarm system's functionality are carried out. Planned cleaning of fire detectors is performed no less than once every 6 months. Comprehensive testing of the fire alarm systems and fire localization systems is conducted annually.

#### 3.2.2. Fire suppression provisions

Buildings 101/2 (Unit 2), 158 are protected by automatic stationary water fire suppression systems (detailed information see in Sections 2.2.4, 2.3.1 of this NAR).

Due to the planned demolition of the shore pumping station building 120/2 (which houses Unit 2 Fire Pumping station) in 2025, a modification of Unit 1 Fire Pumping station is scheduled to be completed by the end of 2024. This modification is aimed at ensuring the operation of the stationary firefighting system for Unit 2 (firefighting systems for Units 1 and 2 are interconnected through common manifolds).

Buildings 157, 157/1 (Solid Waste Retrieval Facility) are protected by stationary gas fire suppression systems (detailed information see in [5.39]).

Internal and external fire pipelines with fire hydrants are used for fire suppression in all Ignalina NPP NIs.

Technical maintenance of fire suppression systems is carried out by the personnel of the Ignalina NPP in accordance with the respective operating instructions. All instances of non-compliance identified during operation, technical supervision (maintenance), and inspections are documented and eliminated.

Monthly checks of the firefighting system control automation are conducted. Pump testing for the firefighting pumps is carried out once per quarter. Comprehensive testing of the firefighting systems and fire localization systems is performed annually.

### 3.2.3. *Administrative and organizational fire protection issues*

The stages and sequence of actions to ensure fire safety in Ignalina NPP (planning, execution, control, analysis, and improvement), as well as indicators and methods for assessing progress, and the distribution of responsibilities during the process, are defined in the Description [5.54]. In accordance with the Law of the Republic of Lithuania on Fire Safety [5.1], legal and regulatory requirements for the organization and management of work in the field of fire safety, a General Fire Safety Instruction has been developed. The instruction contains basic fire safety requirements for the content of the enterprise's territory and buildings, storage of hazardous chemicals and reagents, supervision of the Control and Protection System, safe conduct of construction work and work on dismantling, installation, and repair of equipment, as well as work involving the use of open flames and spark emission. The instruction also includes requirements for the training and certification of personnel, conducting drills and exercises, as well as instructions for personnel actions in case of a fire, among others.

The procedure and responsibilities of department directors, heads of divisions, as well as all personnel of the Ignalina NPP when receiving signals and verbal messages from civil defense and emergency preparedness siren system in case of accidents and emergencies are defined in Ignalina NPP Emergency Preparedness Plan.

Training, knowledge testing, and certification of personnel according to the Fire Safety knowledge program are carried out for all Ignalina NPP personnel by certain categories, not less than once every five years. Access to independent work is granted after knowledge testing and certification of the employee on fire safety issues. Annual periodic instructions on fire safety are given to all employees, and additional instructions are provided if necessary.

In each department and division of the enterprise, individuals responsible for the fire safety of the territories, buildings, premises, production areas, laboratories, workshops, and equipment belonging to these departments and services are appointed by orders of their directors and leaders. All persons responsible for the fire safety of the territories, buildings, and premises undergo certification in fire safety in accordance with the established procedure.

Training and drills of staff in fire extinguishing, including in an environment unfit for breathing and using breathing apparatus, is carried out. Regular training sessions are conducted in fire extinguishing and personnel evacuation in departments, as well as joint training of personnel of the Ignalina NPP and VFRS.

The elimination of fires at the Ignalina NPP NIs is carried out in accordance with the Plan [5.18]. For the elimination of fires in the cable and electrical rooms of Ignalina NPP Units 2, Operational Firefighting Cards [5.55] are additionally used, which are reviewed in a timely manner.

The technical supervision (maintenance) of the active fire protection systems is carried out by the personnel of the Ignalina NPP in accordance with the relevant operating instructions. All cases of non-compliance detected during operation, technical supervision (maintenance) and inspections are documented and eliminated.

Coordination of work on fire safety issues, as well as monitoring the proper fire safety condition of Ignalina NPP NIs, is carried out by personnel of the Safety oversight and quality management division.

In accordance with the requirements of legal and regulatory documents on fire safety, the state fire supervision and extinguishing of possible fires at the enterprise are carried out by the units of the VFRS.

## 3. FIRE PROTECTION CONCEPT AND ITS IMPLEMENTATION

The VFRS consists of two round-the-clock firefighters teams, equipped with all the necessary firefighting equipment, including fire trucks, mobile pumping stations and mobile ladders (see Figures 3.2.3-1).



Figure 3.2.3-1. Part of the Visaginas Fire and Rescue Service firefighting equipment

According to the Plan for Consolidation of Fire and Rescue Forces of Visagino Municipality for the Elimination of Incidents and Emergencies, additional Fire and Rescue Forces from neighboring districts may also be called upon to assist in extinguishing the fire.

The interaction between Ignalina NPP personnel and the officials of arriving fire and rescue units during a fire is carried out in accordance with the [5.18]. Ignalina NPP NIs are accessible to the fire and rescue vehicles via existing internal roads within the Ignalina NPP premises, and there are no obstacles along the transport routes. Entry into buildings is provided through transport gates, and areas, platforms, and piers are equipped near external water bodies (such as the conduit channel near Buildings 120/1 and 120/2) for the placement of fire vehicles.

In 2014, the VFRS was relocated to a different, more remote building (7 km away from Ignalina NPP). The estimated arrival time of firefighters and rescuers at the Ignalina NPP facilities for firefighting purposes is 6-7 minutes.

For effective firefighting, the Plan for Consolidation of Fire and Rescue Forces of Visaginas Municipality for the Elimination of Incidents and Emergencies includes detailed fire plans for all Ignalina NPP NIs. Each fire plan contains information about the NI, the nearest fire hydrants, instructions for the VFRS (see examples of firefighting plans in Figures 3.2.3-2, 3.2.3-3, 3.2.3-4, 3.2.3-5, 3.2.3-6, 3.2.3-7).

3. FIRE PROTECTION CONCEPT AND ITS IMPLEMENTATION

**ĮVYKIO LIKVIDAVIMO PLANAS**

2020 - 12 - 31      Nr. 17      1 PIN RAD  
 (sudarymo data)      (plano numeris)      (pajėgų išsiuntimo numeris)

Objekto GPS koordinatės: 55.603779, 26.580283

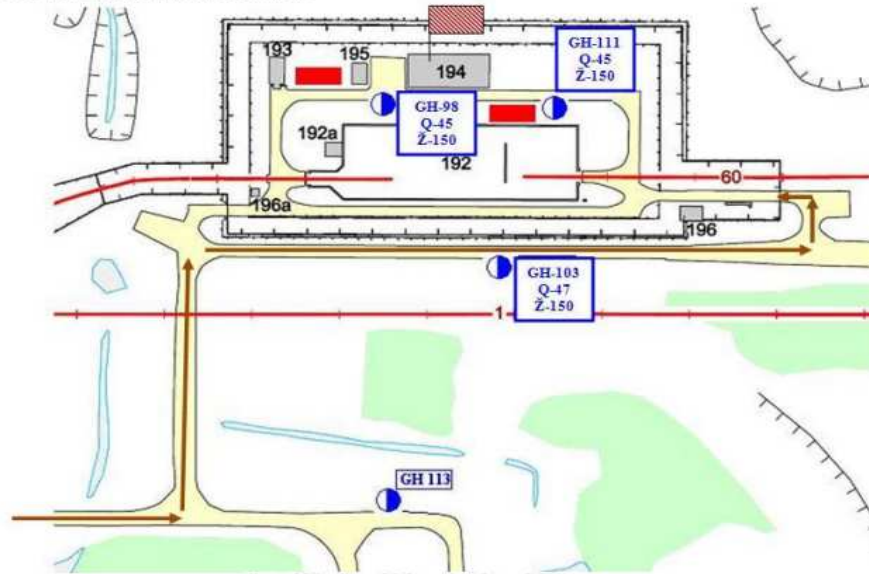

- Past. 194 - Gamybinis - administracinis korpusas;
- Stat. 192 - Konteinerių saugojimo aikštelė atviro tipo;
- Past. 192 A - Personalo kontrolės ir apšildymo pastatas;
- Past. 193 - Transformatorinė;
- Past. 195 - Siurblinė;
- Past. 196 - kontrolinis praleidimo punktas;
- Past. 196 A - Vartų valdymo pastatas;
- - Gaisrinis skystas.

**194 PASTATO PLANAS**

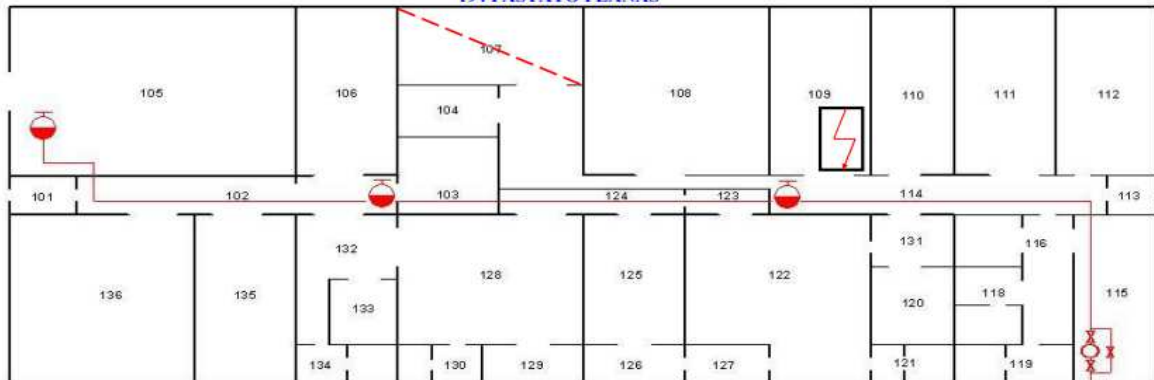

Figure 3.2.3-2. Partial view of the SNSF-1 firefighting plan

3. FIRE PROTECTION CONCEPT AND ITS IMPLEMENTATION

**ĮVYKIO LIKVIDAVIMO PLANAS**

2020 - 12 - 31      Nr. 23      2 PIN RAD

(sudarymo data)      (plano numeris)      (pajėgų išsiuntimo numeris)

Objekto GPS koordinatės: 55.593942, 26.554401

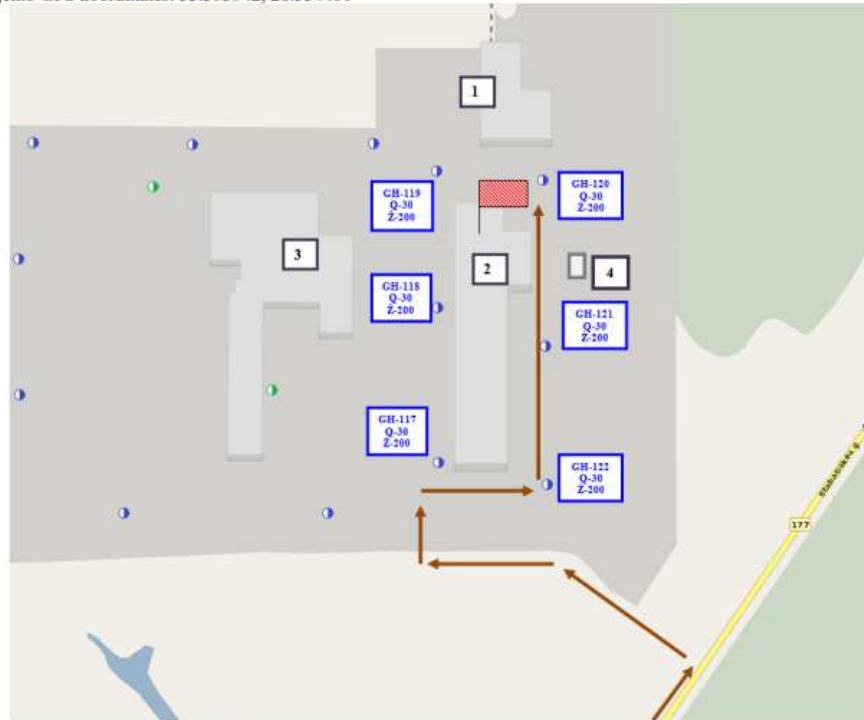

- 1 – Kontrolinis praleidimo pastatas (geležinkelio pagalba bus atvežami panaudoto branduolinio kuro konteineriai);
- 2 – Laikinoji panaudoto branduolinio kuro saugykla past. B1 (42 m x 159 m = 6678 m<sup>2</sup>);
- 3 – Kietųjų radioaktyviųjų atliekų apdorojimo ir saugojimo kompleksas past. B3/4.
- 4 – Elektros paskirstymo pastote. Rezervinis elektros generatorius (nutrūkus elektros energijos tiekimui, palaiko B1 pastato ventiliacijos sistemos veikimą).

**BI PASTATO IŠDĖSTYMO PLANAS**

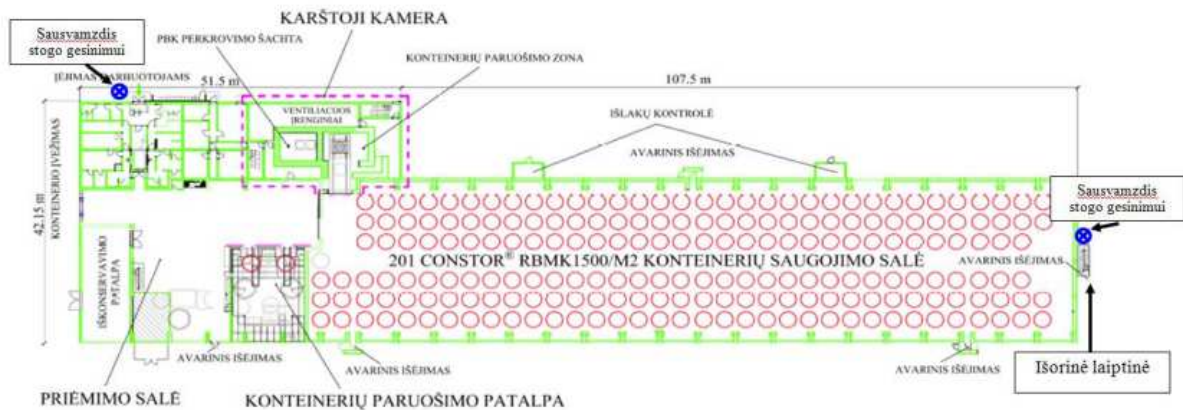

Figure 3.2.3-3. Partial view of the SNSF-2 firefighting plan

3. FIRE PROTECTION CONCEPT AND ITS IMPLEMENTATION

**ĮVYKIO LIKVIDAVIMO PLANAS**

2020 - 12 - 31

Nr. 15

1 PIN RAD

(sudarymo data)

(plano numeris)

(pajėgų išsiuntimo numeris)

Objekto GPS koordinatės: 55.604186, 26.54959

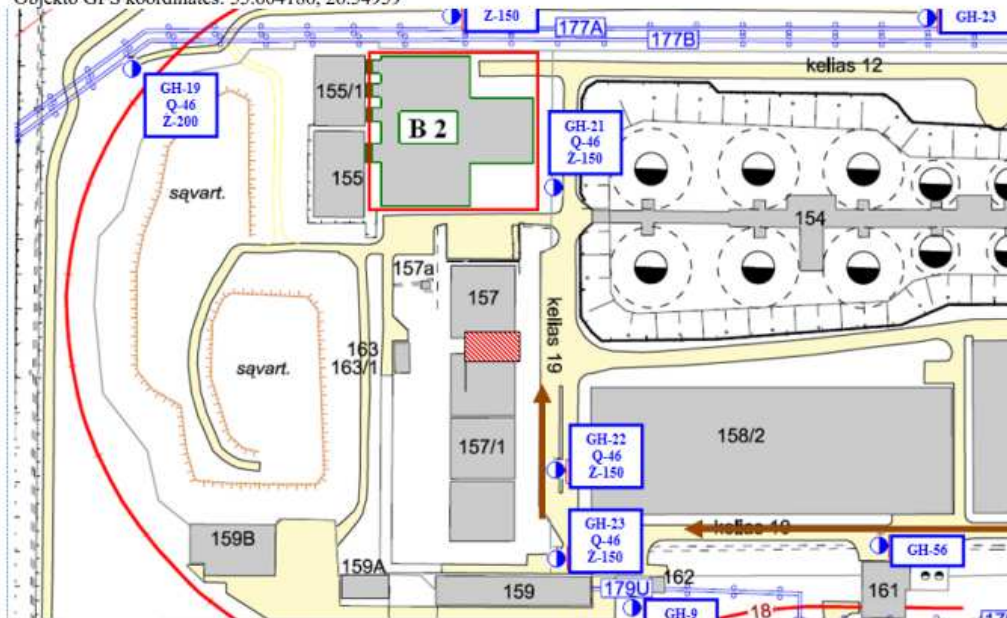

157 past. – kietų radioaktyvių medžiagų saugykla (IM3(išėmimo modulis(26 m x 30 m = 780 m<sup>2</sup>)));  
 157/1 past. – kietų radioaktyvių medžiagų saugykla (IM2(išėmimo modulis(26 m x 80 m = 2080 m<sup>2</sup>)));  
 163, 163/1 past. – gesinimo dujomis stotis;  
 B2 past. - kietųjų radioaktyviųjų atliekų tvarkymo kompleksas (montuojamas);  
 155, 155/1 past. – mažai radioaktyvių medžiagų saugykla (IM1(išėmimo modulis)).

**KIETŲ RADIOAKTYVIŲ MEDŽIAGŲ SAUGYKLŲ 157 IR 157/1 PASTATŲ IŠĖMIMO MODULIŲ IM2 IR IM3 SCHEMAS**

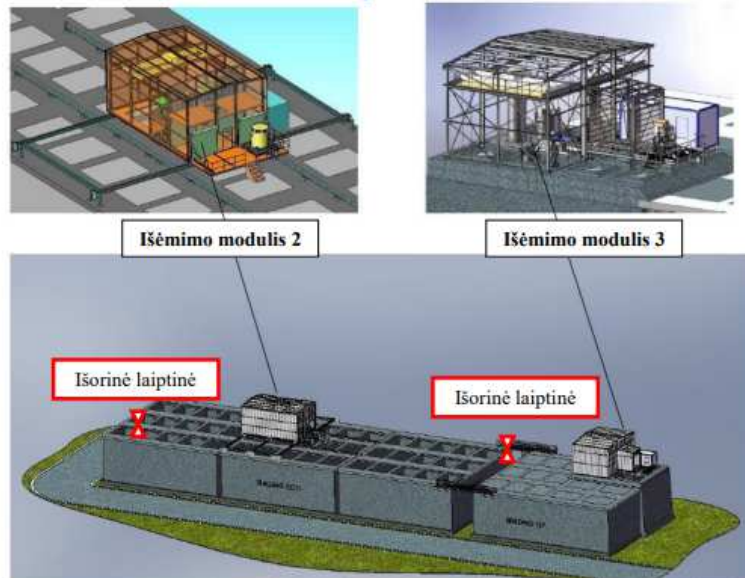

Figure 3.2.3-4. Partial view of the SWRF firefighting plan

3. FIRE PROTECTION CONCEPT AND ITS IMPLEMENTATION

**ĮVYKIO LIKVIDAVIMO PLANAS**

2020 - 12 - 31      Nr. 24      2 PIN RAD  
 (sudarymo data)      (plano numeris)      (pajėgų išsiuntimo numeris )

Objekto GPS koordinatės: 55.594358, 26.552317

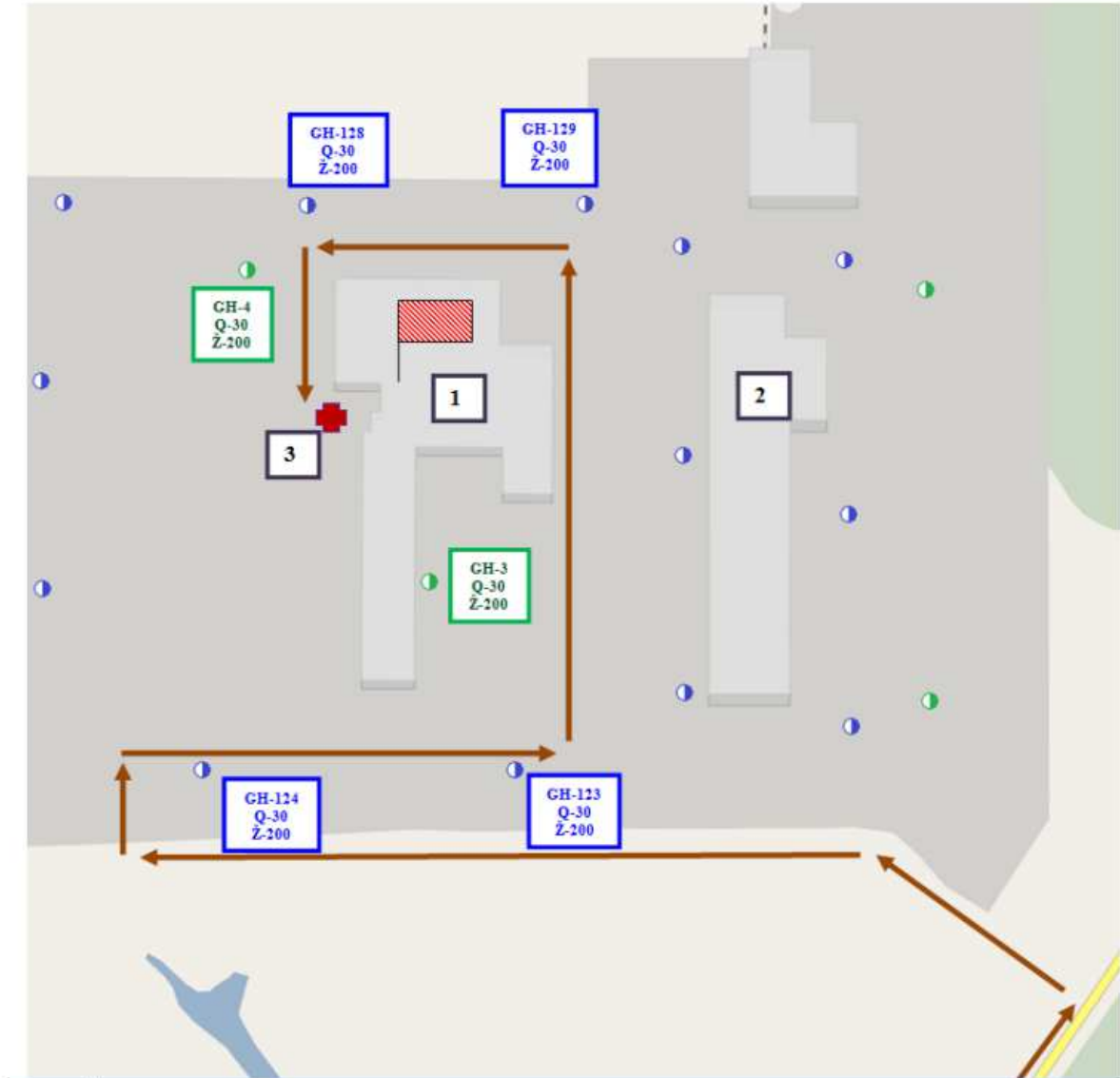

Figure 3.2.3-5. Partial view of the SWTSF firefighting plan



**ĮVYKIO LIKVIDAVIMO PLANAS**

2020 - 12 - 31

Nr. 5

2 PIN RAD

(sudarymo data)

(plano numeris)

(pajėgų išsiuntimo numeris )

Objekto GPS koordinatės: 55.603967, 26.553574

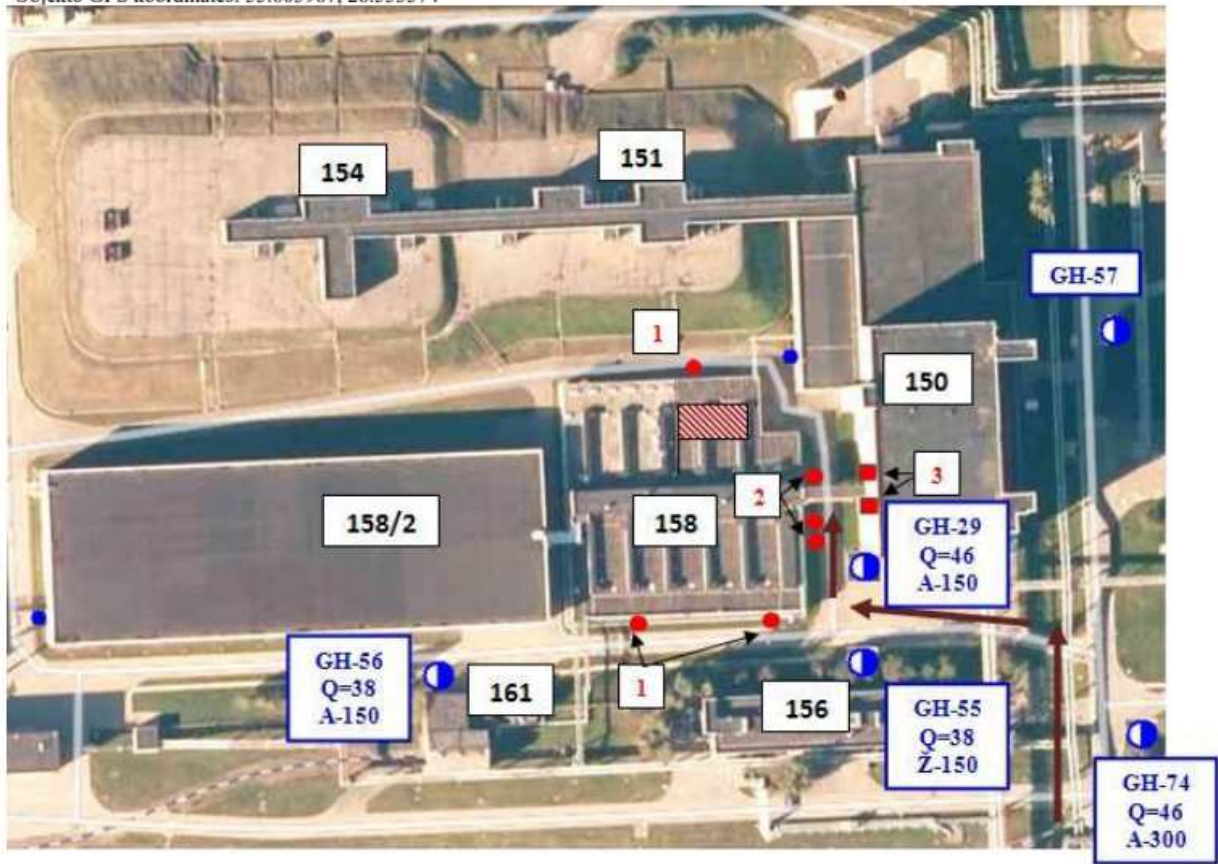

Figure 3.2.3-6. Partial view of the building 158 firefighting plan

3. FIRE PROTECTION CONCEPT AND ITS IMPLEMENTATION

**ĮVYKIO LIKVIDAVIMO PLANAS**

2020 - 12 - 31

Nr. 1

2 PIN RAD

(sudarymo data)

(plano numeris)

(pajėgų išsiuntimo numeris)

Objekto GPS koordinatės: 55.604787, 26.565081



1 – 101 pastatas energo-blokas

**101 PASTATO ENERGO-BLOKO TERITORIJOS PLANAS**

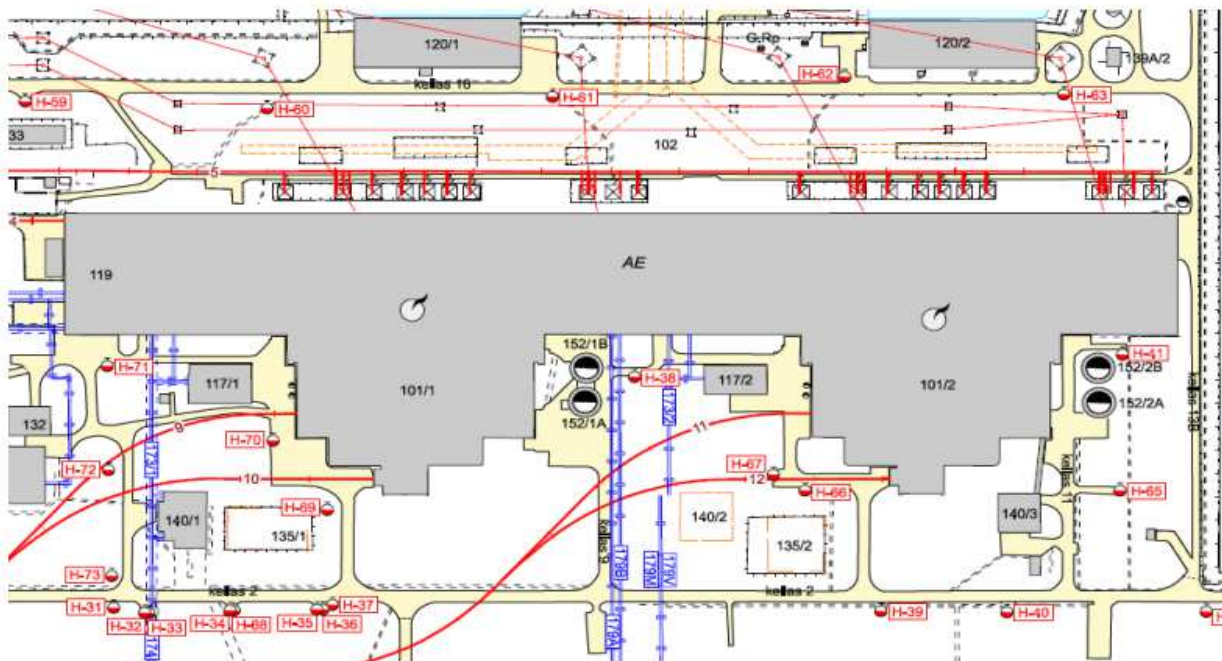

Figure 3.2.3-7. Partial view of the Ignalina NPP Unit 2 firefighting plan

#### **3.2.4. *Regulator's assessment of the active fire protection***

VATESI has set out in its requirements that the selection, design and layout of extinguishing systems, taking into account the relevant fire hazard challenges for safety important SSCs and any associated potential release, must always be subject to an FHA, which must assess the suitability and sufficiency of the selected extinguishing systems. This method is being applied to all NIs mentioned in this NAR. VATESI conclusion based on result of review that SE Ignalina NPP ensuring the operation and maintenance of active fire protection equipment, as well as the necessary measures in accordance with fire protection requirements, enable the provision of fire protection and safety for NIs, which was confirmed by the conclusions of the SARs and FHA. The implementation of measures based on the recommendations of the FHA increased the fire safety of NIs as a result, they were able to meet international standards.

Pursuant VATESI regulatory requirements, in case of licensee SE Ignalina NPP needs to disable fire detection systems in a certain location while performing temporary works, it should be ensured that alternative fire protection measures are implemented to comply with regulatory requirements.

VATESI performs regular inspections in the buildings 101/2 (Unit 2), 158, buildings 157, 157/1 (Solid Waste Retrieval Facility), that are protected by automatic stationary water and gas fire suppression systems.

VATESI also supervises how employees of SE Ignalina NPP are trained, instructed and certified in fire safety issues and fire preventions actions. This information also is provided to VATESI in the annual nuclear safety reports of the SE Ignalina NPP.

The regulatory framework and authorization process ensures that VATESI issues NIs licenses and permits to carry out activities only after making sure that sufficient fire-fighting capabilities are available, responsibility for fire-fighting has been properly determined and all organizational issues of fire-fighting have been resolved. SE Ignalina NPP has developed procedures to ensure that external firefighting forces are familiar with the hazards of NIs. SE Ignalina NPP's firefighting readiness is ensured by conducting training, exercises and training in emergency situations for both its own and external firefighting forces.

### **3.3. *Passive fire protection***

#### **3.3.1. *Prevention of fire spreading (barriers)***

The design solution involves the division of buildings and structures into fire compartments and sectors. Rooms of different categories in terms of explosion and fire hazards are separated from each other using enclosing structures or fire barriers with specified fire resistance class and their fire endurance limit.

The application and repair of fire-resistant coating on load-bearing metal structures of the Ignalina NPP NIs are carried out in accordance with Instruction [5.56]. The application and repair of fire-resistant coating on the jackets of electrical cables and fire-resistant easily-penetrable fillers of cable penetrations in cable engineering structures of the nuclear power plant are carried out in accordance with Instruction [5.57].

#### **3.3.2. *Ventilation systems***

The principle of localizing fire-hazardous rooms is fundamental in designing ventilation systems for all Ignalina NPP NIs. It involves the installation of "passive" flame-retardant valves, in addition to

electrically operated shut-off valves, such as air dampers and welded air ducts of increased fire resistance between the valves and dampers. Flame-retardant valves are installed in the duct passages through walls and are activated (closed) at an air temperature around the valve of  $t = 70^{\circ}\text{C}$ . Air dampers are automatically closed by a "Fire" signal. The fire resistance of air ducts between valves is increased by applying a shell of heat-insulating materials. Combining air ducts between fire-hazardous and non-fire-hazardous rooms is not allowed. Cable shafts are serviced by supply and exhaust ventilation systems. Flame-retardant valves are installed on air ducts at the intersection of fire-resistant walls. The ventilation of cable shaft rooms, separated by fire-resistant floors, is carried out floor by floor, with the branches serving the cable shaft rooms combined into one collector on three sequentially located floors. Electrically operated dampers are installed on the collectors. The ventilation shutdown systems aim to reduce the consequences of a fire by automatically disconnecting the supply and exhaust fans to stop the air supply to the fire source.

For the localization of fires and the reduction of their consequences at the Ignalina NPP, the following automatic systems (more details can be found in the sections 2.1-2.3 of this NAR), are used, activated upon the activation of the fire alarm:

- closure of fire dampers in supply and exhaust ventilation systems in the room where the ignition occurred, in order to localize it (fire dampers) – SNFSF-2, SWTSF, Ignalina NPP Unit 2;
- shutdown of supply and exhaust system fans to prevent air from entering the fire zone (ventilation shutdown) - SNFSF-1, SNFSF-2, SWRF, SWTSF, building 158/2, Ignalina NPP Unit 2;
- removal of combustion products from protected areas (smoke removal) – Ignalina NPP Unit 2;
- forced air supply and creation of excess pressure in elevator shafts and stairwells to ensure safe personnel evacuation (air support ventilation systems) - SNFSF-2, SWTSF, Ignalina NPP Unit 2;
- smoke localization in a separate compartment of the pedestrian corridor to ensure safe personnel evacuation (automatic door closure) - SWTSF, Ignalina NPP Unit 2.

### **3.3.3. *Regulator's assessment of the passive fire protection***

It is determined in the VATESI requirements that during the NIs design stage, NIs buildings, in which safety important SSC are planned to be installed, must be divided into fire departments and fire chambers, which must be located inside the fire department. Segregation must be done in such a way that, in the event of a fire, it is ensured that the fire does not spread through the fire barriers and that radionuclides are contained so that they do not enter the environment. In the FHA justification provided by SE Ignalina NPP, the division of NIs into fire departments is carried out properly and they will be able to perform the functions assigned to them.

During VATESI inspections, it was checked whether the fire departments are sealed, whether they comply with the design, whether the access roads for extinguishing fires are accessible, how safe access to extinguish fires is ensured, whether the fire departments do not have temporary and permanent fire loads not foreseen in the design documentations. Also VATESI checks NIs safety important ventilation systems, involves the installation of "passive" flame-retardant valves, in addition to electrically operated shut-off valves (air dampers and welded air ducts) of increased fire resistance between the valves and dampers.

During the inspection, which was carried out in 2021 at SWTSF, VATESI inspectors found that the fire departments penetration, through which pass the technological system, is not properly sealed. After receiving VATESI remark, SWTSF employees immediately eliminated this deficiency and checked the entire SWTSF to see if there were any more similar problems.

NATIONAL ASSESSMENT REPORT OF THE REPUBLIC OF LITHUANIA	Page 157 of 163
3. FIRE PROTECTION CONCEPT AND ITS IMPLEMENTATION	

### 3.4. Licensee's experience of the implementation of the fire protection concept

All fires at the Ignalina NPP NIs, including false alarms of the active fire protection system, are analyzed by commissions appointed by the general director of the Ignalina NPP. Reports are sent to the Fire and Rescue Department under Ministry of the Interior and the VATESI, and the implementation of corrective measures is monitored.

Between 2010 and 2023, there were 7 false activations of the sections of the stationary fire extinguishing systems in the 1st and 2nd units of Ignalina NPP. False activations did not lead to the loss of functioning of safety important SSCs. False activations of the sections of the stationary fire extinguishing systems were caused by external impacts on the equipment of the stationary fire extinguishing systems (partly due to erroneous actions of personnel when organizing work in the area of operation of the systems). At present, there is a tendency to reduce the number of false activations after implementing corrective measures.

On October 8, 2016, during the scheduled testing of diesel generator 7 of the backup diesel power station (located 150 meters away from Ignalina NPP Unit 2), combustion of exhaust fumes was discovered in its exhaust pipe. The diesel generator was shut down unexpectedly, after which the combustion intensity in the exhaust pipe and muffler decreased. The arriving VFRS managed to localize the fire within 26 minutes. Subsequently, it was determined that the combustion of accumulated deposits occurred in the section of the exhaust gas pipeline before the muffler and inside the muffler itself. As a result of the event analysis, an Event Report (At-2451(3.165), dated November 18, 2016) was issued, identifying the direct (the factory documentation does not sufficiently define the criteria for assessing contamination and the methods of cleaning the muffler) and root (lack of supervision over the procedure) causes of the event, and corrective measures (development of a procedure for inspecting and cleaning the exhaust gas pipeline and muffler; analysis of operational documentation and maintenance repair documentation for compliance with factory and project requirements, considering operational experience) were developed and implemented.

On April 23, 2017, due to the overheating of the power supply transformer in the electrical cabinet on Ignalina NPP Unit 2, smoke was generated in the room, which was detected by the fire alarm system. As a result of the event analysis, an Event Report (At-1828(3.165), dated May 29, 2017) was issued, identifying the direct (overheating of the power supply transformer) and root (lack of supervision over the scope of work during technical maintenance) causes of the event, and corrective measures (modification of the procedure for performing technical maintenance work.) were developed and implemented.

On April 1, 2022, a fire occurred in the turbine hall of Ignalina NPP Unit 2 due to improper organization of welding works during the dismantling of metal structures, resulting in the ignition of the covering film of containers containing operational waste. The fire was extinguished within 1 hour through the joint efforts of the VFRS and the staff of the Ignalina NPP. As a result of the event analysis, an Event Report (At-2472(3.165E), dated September 6, 2022) was issued, identifying the direct (failure to adhere to the procedure for organizing safe hot work; the observer failed to fulfill their duty to monitor the dispersion of molten metal and prevent its contact with flammable materials and substances) and root (lack of personnel supervision; the supervision of personnel during the dismantling work was inadequate) causes of the event, and corrective measures (personnel re-certification; conducting additional briefings; training for event participants on safety culture) were developed and implemented.

### 3.5. Regulator's assessment of the fire protection concept and conclusions

VATESI carries out regular inspections at the licensee according inspection program in order to check the compliance with the legal requirements and international safety standards and the best practices. The inspection program includes several special fire safety inspections (fire prevention, active fire protection - fire detection (alarms) and fire supervision provisions, passive fire protection - prevention of fire spreading (barriers)), which exclusively concentrates on condition monitoring, maintenance activities and implementation of corrective measures.

Planning of SE Ignalina NPP decommissioning started 24 years ago, when in 1999 a preliminary decommissioning plan (FDP) was prepared. FDP is a key document describing the decommissioning of a NIs. It covers the entire Ignalina NPP decommissioning period and describes the Ignalina NPP NIs: both energy units, radioactive waste management facilities, and various auxiliary structures that are not required in the long term. The document also describes the general fire protection concept of the planned works. VATESI evaluated the fire protection concept presented by SE Ignalina NPP and approved it.

However, gained experience of decommissioning activity at Ignalina NPP units shows that decommissioning projects have significant impact to fire protection assurance because of new equipment and/or modifications implementation. Sometimes, some hot works performance requires modify an active fire protection system temporally. In those cases, licensee apply addition measures to assure safety during hot works performance. Some modifications require to change a Firefighting Plans and examine it in practice. VATESI evaluate those modifications (change), related with safety important SSCs are assessed properly taking into account fire safety aspects as well.

Considering above mentioned, it could be concluded that SE Ignalina NPP has established all the necessary means for provision of fire safety and successful firefighting in all NIs.

### 3.6. Conclusions on the adequacy of the fire protection concept and its implementation

Organization and management at the Ignalina NPP for decommissioning and waste management activities enable the planning and safe execution of equipment dismantling and decontamination projects, taking into account available resources, structural configurations, systems and components.

According to the assessment results, the safety important SSCs meet design and functional fire safety requirements and can fulfill their assigned functions during the decommissioning and waste management processes.

The analysis of fire safety measures and fire hazard shows that conditions for rapid fire spread are absent at the Ignalina NPP. The concept of "defense in depth" at the NIs ensures the functions of fire prevention, detection, suppression and consequence mitigation, allowing safety important SSCs to perform their functions.

The analysis revealed that the process of intense ageing of fire protection heat-mechanical equipment, subject to ageing management, has not commenced. Ageing of the cable, electrical equipment, automation and measurement components have not reduce the reliability of safety important SSCs. Existing maintenance procedures at the SE Ignalina NPP ensure the timely identification and elimination of deviations. The results of the analysis of the effectiveness of managing fire protection heat-mechanical equipment, building structures, electrical equipment, and instrumentation meet fire safety criteria, and the operation of SSCs is within the range of normal operation.

## 3. FIRE PROTECTION CONCEPT AND ITS IMPLEMENTATION

All fire events that occurred during the considered period are classified outside the INES scale or at the zero level. All such events have been analyzed and appropriate measures were implemented. In order to prevent any fire events at the NIs, a practice has been adopted for preparing and revising work procedures in consideration of changing operational conditions, work structure, organizational and structural changes.

Additional fire safety enhancement measures at the Ignalina NPP are agreed on with VATESI and carried out in accordance with the annual Safety Improvement Program of the Ignalina NPP.

The use of accumulated experience, particularly one's own experience, in any NIs operations is a crucial component of fire safe in global practice. At the Ignalina NPP, the entire process of preserving, utilizing, and passing on its own experience has been maintained at a high level throughout its operational period, as confirmed by inspections and assessments by VATESI among others. Enhanced attention to fire safety is ensured through strict adherence to rules and instructions in this area, as well as through monitoring and inspections by relevant government entities. Maintaining the qualifications of all personnel, who ensure fire safety of NIs, is achieved through regular training and certification, as well as through staff drills and exercises at the Ignalina NPP.

It can be concluded that fire protection concept the overall time is properly applied at Ignalina NPP NIs.

## 4. OVERALL ASSESSMENT AND GENERAL CONCLUSIONS

**4. Overall Assessment and General Conclusions**

Based on the provided information, the main conclusion that can be drawn is that the SE Ignalina NPP complies with all regulatory legal requirements on fire safety, does not impact the radiation safety of the public and environment, and effectively manages the aging process of fire protection SSCs ensuring they meet the design requirements both during operation and the decommissioning phase.

The assessment results demonstrate that the NIs of SE Ignalina NPP are in full compliance with the design specifications and regulations related with fire safety. This compliance is maintained continuously and demonstrated during PSR. Given the decommissioning activities at the Ignalina NPP, this continued compliance with fire safety requirements is ensured through the implementation of measures outlined in the technological projects of decommissioning. The fire safety is justified in corresponding fire safety assessment reports.

To ensure the safe and effective operation and decommissioning of NIs, it is recommended to continue analyzing domestic and foreign operating experience and applying fire safety good practices in those NIs.

To prevent any fire events during the decommissioning period, it is advisable to maintain the practice of preparing and revising work procedures in consideration of changing operational conditions, work structures changes.

For the continued safe operation of SSCs of the Ignalina NPP NIs, it is recommended to, in addition to maintaining and supporting the established practice of strict adherence to regulatory fire safety requirements, rules, instructions, and procedures, as well as collaboration with regulatory authorities, pay special attention to the aging of SSCs important to fire safety, regardless of their remaining operational life.

VATESI after conducting a fire safety review of the SNFSF, WSF and Ignalina NPP Unit 2 under decommissioning in this NAR, concluded that the overall fire safety approach is properly applied at SE Ignalina NPP.

Fire safety issues periodically check NIs fire safety specialists from the Safety surveillance and quality management division of the SE Ignalina NPP.

The periodic inspections on fire safety are performed by VATESI at NIs in accordance with annual plans, based on five-year inspection program and they tackle both the organizational issues and technical aspects. VATESI also has resident inspectors at the Ignalina NPP, who conduct regular walk downs across the site and supervise how fire safety is ensured in the NIs.

In addition to VATESI, the periodic inspections on fire safety are performed by specialists from the Fire and Rescue Department under Ministry of the Interior.

All modifications related to safety important SSCs are being prepared and installed at the NIs only after assessing their impact on fire safety. At the initial stage of each modification, it is always required (in according to VATESI requirements) to assess whether there will be no negative impact on NIs fire safety during the execution of this modification.

The PSR is performed for all NIs specified in this NAR each 10 year. During periodic safety review it is assessed and demonstrated that the fire safety of these NIs meets the fire safety requirements as well.

Fire safety adequacy at NIs is also ensured by means of SE Ignalina NPP integrated management system which provides controls of: storage of inflammable material amounts; temporary fire loads;



## 4. OVERALL ASSESSMENT AND GENERAL CONCLUSIONS

provision of safe hot works; preventing of inflammable package bringing into specific areas; fire safety instructions to personnel; personnel training; actions in case of fire. Taking into account above mentioned, it can be concluded that SE Ignalina NPP has established all the necessary means for provision of fire safety and successful firefighting.

A general lesson learned from a fire protection point of view decommissioning and dismantling activities the risk of fire and the need to give more attention to these issues: constantly changing environment, more frequent assessment of fire protection risks and increased implementation of their control measures requires to take more attention and resources.

During the fire safety review of SE Ignalina NPP SAR, PSR, modifications documents and VATESI fire safety inspection documents it was found that all NIs specified in this NAR meet the national and other modern international fire safety requirements.

Nevertheless, Ignalina NPP must continue perform fire safety supervision, analyze operation and decommissioning experience and maintain high level of fire safety at all NIs in Lithuania.

## 5. REFERENCES IN THE NAR

**5. References in the NAR**

- 5.1. Law on Fire Safety.
- 5.2. Law on Nuclear Energy.
- 5.3. Law on Nuclear Safety.
- 5.4. Government Resolution No. 722 On Approval of Rules of Procedure for Issuing Licenses and Permits in the Area of Nuclear Energy.
- 5.5. Government Resolution No. 83 On Approval of Rules of Procedure of the Assessment of the Nuclear Facilities' Site Evaluation Report.
- 5.6. Government Resolution No. 1406 On Approval of Rules of the Statute of State Nuclear Power Safety Inspectorate.
- 5.7. Government Resolution No. 739 On Approval of Regulations of state fire protection.
- 5.8. Fire detection and alarm systems. Design and installation.
- 5.9. Internal fire water supply systems of buildings. Design and installation.
- 5.10. Outdoor fire water supply networks and structures. Design and installation rules.
- 5.11. General rules of fire safety.
- 5.12. Fire extinguisher maintenance rules.
- 5.13. Technical requirements of fire dampers (valves).
- 5.14. Technical requirements of fire ducts.
- 5.15. General fire safety.
- 5.16. Recommendations for maintenance of fire safety engineering systems.
- 5.17. Inventory of the requirements for the technical measures of the warning system.
- 5.18. The plan for mobilizing the fire rescue forces of the municipality of Visaginas for liquidation of extreme events (2021), No. ĮG-1067.
- 5.19. Rules for the organization of fire fighting and other rescue operations performed by the fire rescue forces (2013). No. 1-280.
- 5.20. Lists of tools and equipment of the State Fire Rescue Service.
- 5.21. Fire safety rules for ventilation systems.
- 5.22. Description of the procedure for organizing the maintenance of the warning system.
- 5.23. Regulations of the Panevėžys Fire Protection and Rescue Board of the Fire Protection and Rescue Department at the Ministry of the Interior.
- 5.24. Instructions for coordinating the composition and technical equipment of fire rescue units (departmental firefighting forces) established in fire-hazardous.
- 5.25. Rules for evaluating the conformity of fire and rescue equipment, fire safety equipment and fire fighting equipment, fire automation equipment.
- 5.26. Mandatory safety requirements for fire extinguishing and rescue equipment, tools and devices, fire extinguishing materials, fire safety signs.
- 5.27. STR 2.01.06:2009, Protection of barrels against lightning. External lightning protection of buildings.
- 5.28. STR 2.01.01(2): 1999, Essential requirements of the structure. Fire safety.
- 5.29. STR 2.09.02:2005, Heating, ventilation and air conditioning.
- 5.30. HN 73:2018, Basic radiation protection standard.
- 5.31. Ignalina Nuclear Power Plant Final Decommissioning Plan. Issue 07 (2014), ArchPD-2241-75525v1.
- 5.32. Safety Report for the Storage Cask CASTOR RBMK. Rev.2 (2006), ArchPD-0745-68754v1.

## 5. REFERENCES IN THE NAR

- 5.33. Safety Report for the CONSTOR RBMK-1500. Storage Cask (2006), ArchPD-0745-67384v1.
- 5.34. Report on the periodic safety assessment of a dry-type spent nuclear fuel storage facility (2016), At-970(3.266).
- 5.35. SNFSF Fire Hazard Analysis (2017), At-4233(3.107).
- 5.36. Final Safety Analysis Report Interim Storage Facility (B1) for RBMK Spent Nuclear Fuel Assemblies from Ignalina NPP Units 1 and 2 (2017), ArchPD-2245-76152V1.
- 5.37. Interim Storage Facility for RBMK spent nuclear fuel assemblies from Ignalina NPP Units 1 and 2 (B1). Updated report. Fire Hazard Analysis (2015), S/14-658.5.9-FHA-01.
- 5.38. Justification of Safety for Placement of Fresh Nuclear Fuel in the SNFSF (addendum to the final safety analysis report for the SNFSF), 2022, Nr.PD-29(19.54E).
- 5.39. New Solid Waste Retrieval Facility (RU2/3) at Ignalina NPP. Retrieval Unit 2 and Retrieval Unit 3, Final Safety Analysis Report (2020), ArchPD-2245-77737v1.
- 5.40. New Solid Waste Retrieval Facility (B2) at Ignalina NPP. Retrieval Unit 2 and Retrieval Unit 3. Final report. Fire Hazard Analysis (2020), S/14-1816.18.18/RU2/3-G-V:02.
- 5.41. New Solid Waste Treatment and Storage Facilities (B34) at Ignalina NPP. B3/4 Final Safety Analysis Report (2022), ArchPD-2245-78151v1.
- 5.42. New Solid Waste Treatment and Storage Facilities (B34) at Ignalina NPP. B3/4. Final Report. Fire Hazard Analysis (2022), ArchPD-2245-78150v1.
- 5.43. Report on the periodic safety assessment of the Liquid Radioactive Waste Cementation Facility complex, buildings 150, 151/154, 158/2 (2018), At-1575(3.266).
- 5.44. Fire Hazard Analysis for equipment and structures of buildings 150, 151/154, 158/2. Final report (2020), ArchPD-1345-77723v1.
- 5.45. Safety Analysis Report, of the Bituminous Waste Storage Facility, Building 158 (2021), ArchPD-1345-78050v1.
- 5.46. Fire Hazard Analysis for Ignalina NPP Bituminous Waste Storage Facility of Ignalina NPP. Final report (2016), ArchPD-1345-76035v1.
- 5.47. Justification of the Existing Storage Facility 158/2 for RBMK-1500 Channel Graphite Waste Temporary Storage. Safety Analysis Report, ArchPD-2245-76808v1.
- 5.48. Decommissioning Safety Analysis Report for Unit 2. Revision 3 (2010), ArchPD-2245-74661v1.
- 5.49. Fire Hazard Analysis of Ignalina NPP Unit 2. Final Draft Report, (2002) ArchPD-0645-69898.
- 5.50. Project B9-0(2). Safety Analysis Report. Dismantling and Deactivation of Equipment in Building 117/2 of Ignalina NPP (2013), ArchPD-2245-75325v1.
- 5.51. Project B9-1(2). Safety Analysis Report. Dismantling and Deactivation of Equipment in the Turbine Hall of the 2nd Block of Ignalina NPP (2014), ArchPD-2245-75474v1.
- 5.52. Project 2214. Safety Analysis Report. Dismantling and Deactivation of Equipment in Block D2 of Ignalina NPP (2018), ArchPD-2245-76887v1.
- 5.53. Project 2210. Safety Analysis Report. Dismantling and Deactivation of Equipment in Blocks A2 and V2 of Ignalina NPP (at the moment, the report is being reviewed and finalized).
- 5.54. Description of the fire safety management procedure, MS-2-006-1, DVSta-0611-1.
- 5.55. Operational fire extinguishing cards for cable engineering structures and electrical rooms, Bln-2 (8.103) ÷ Bln-75 (8.103).
- 5.56. Instructions for applying and repairing the fireproof coating on metal structures of nuclear power plant buildings, DVSeD-1012-54.
- 5.57. Instructions for repairing the fireproof coating of electrical cable jackets and fire-resistant easily penetrated cable penetrations in cable engineering structures of nuclear power plants, DVSeD-0612-14.
- 5.58. Modification report, PTOmod-1645-281.